



küttesüsteemid • müük • paigaldus • hooldus
tel +372 442 0222 / +372 434 1000 • www.cerbos.ee • info@cerbos.ee

Product Catalogue

LK Armatur



Table of Contents

LK ARMATUR - A One-Stop Supplier	4	SOLAR PUMP UNITS	97
LOADING UNITS	7	LK 201 SmartSolar	98
LK 810 ThermoMat 2.0 G Eco	8	LK 202 SmartSolar	100
LK 810 ThermoMat 2.0 W Eco.....	11	SMARTSOL/SMARTSOLAR - Applications	102
LK 811 ThermoMat E Eco	14	ZONE VALVES	103
LK 815 ThermoKit T Eco.....	19	LK 525 MultiZone 2W.....	104
LK 816 ThermoKit E Eco.....	21	LK 525 MultiZone 3W.....	106
PUMPGROUPS	23	LK 525 MultiZone Polar	108
LK HydronicGroup 90.....	24	LK 525 MultiZone Solar	110
LK HydronicGroup 125.....	26	LK 525 MultiZone 3R.....	112
THERMIC VALVES AND CHECK VALVES	29	LK 527 MultiZone 2W.....	114
LK 820 ThermoVar®	30	LK 527 MultiZone 3W.....	117
LK 821 ThermoVar®	34	APPLICATIONS	120
LK 823 ThermoVar®	38	FILLING VALVES	121
LK 822 ThermoBac	41	LK 521 MultiFill®	122
LK Insulation.....	44	LK 538 ThermoFill® EA.....	124
MIXING VALVES	45	LK 539 ThermoFill® EA.....	126
LK 830 ThermoMix® B	46	VALVES FOR WATER HEATING	127
LK 831 ThermoMix® B	48	LK 510/511/512 MultiSafe.....	128
LK 840 ThermoMix® 2.0.....	50	LK 514 MultiSafe.....	130
LK 840 ThermoMix® C	54	LK 548 AquaKit	131
LK 841 ThermoMix® 2.0.....	57	LK 550 AquaMix	133
LK 842 ThermoMix® P	60	LK 551 HydroMix	135
LK 843 ThermoMix®.....	62	LK 551 F HydroMix	138
LK 845 ThermoMix®.....	64	LK 551 HydroKit Solar.....	140
LK 846 ThermoMix®.....	66	LK 551 HydroKit HWC	141
LK 850 ThermoMix® H.....	68	PRODUCTS FOR UNDERFLOOR HEATING	143
LK 851 ThermoMix® H.....	70	LK 420 MiniShunt 2.0.....	144
LK 525 MultiZone 3R.....	72	LK 421 Manifold Shunt.....	146
LK Insulation.....	74	LK 422 Manifold Shunt Tmax	148
TEMPERATURE CONTROLLERS	75	LK 430 Manifold.....	150
LK 100 SmartComfort CT.....	76	LK 435 OptiFlow	152
LK 110 SmartComfort.....	78	LK 440 EasyHeat	154
LK 120 SmartComfort.....	80	LK 460 EasyHeat	155
LK 130 SmartComfort.....	82	OTHER PRODUCTS	157
VALVE ACTUATORS	85	LK 315 BallValve	158
LK 941 EasyMix	86	LK 519 ThermoSafe	159
LK 950 Valve Actuator	87	LK 522 FilterBall	160
MOUNTING KITS	88	LK 700/705 AeroMat	161
DIFFERENTIAL TEMPERATURE CONTROLLERS	89	LK 924/925 SafetyGroup	162
LK 150 SmartSol.....	90	LK MultiConnection	164
LK 160 SmartBio®.....	92	Prefabricated pipes.....	167
LK 162 SmartStove®	95	Transition Fittings.....	169
		Assembly Instructions for Compression Fittings	170
		Media.....	170

LK Armatur

- A One-Stop Supplier

OUR COMPANY

Our business area was founded in 1985 when the LK Group widened its focus to provide heating system and calorifier manufacturers with valves and components.

By constant development and response to market demand for new products and services. LK Armatur has grown to become an important supplier of valves, components and prefabricated units for the global OEM and distributor market. We produce more than one and a half million valves per year, ranging from simple standard valves to sophisticated, customized special products.

We focus on customers who see energy saving and environmental awareness as a matter of course. The risk of energy shortage, the steady increase in energy prices and the problem of global warming have created a great need for cost and energy efficient heating systems in which renewable energy sources can be utilized. The common denominator for our customers is their stringent requirements for quality, customization and delivery reliability.

Our aim is to be a complete business partner within the HVAC sector. This is why offering high quality products is not enough - the products must also be in the right place at the right time. We have made it our priority to accept general responsibility for logistics and we make sure that our deliveries arrive at our customer's workplace at the right time, clearly marked and packaged as per request. In this way we contribute to lowering our customers' production costs.

Machinery and technology have their places but what makes a company successful is people. That's why we focus on the employees - competence and skill are important keys to success. Education and development are natural parts of the culture at LK as we work according to the Lean production method with continuous improvement and progress.

Our management system complies with ISO 9001:2008 and ISO 14001:2004 for the development, manufacture and distribution of valves, electronic heating controls and prefabricated systems.



OUR PRODUCTS

Our aim is to provide high quality, technically advanced products that are easy to install and uncomplicated to use. We constantly develop and design new products. Our technical staff often participate at the idea stage and are able to help our customers with not just the right product but also with complete packages that save time and money.

We offer our customers a wide range of products consisting of valves, electronic heat regulation, prefabrication of customized pipes and units as well as supplementary trade products.



VALVES

Our core business is based on our own manufacture of valves. Thanks to our deep knowledge of the field combined with the latest technology, we can provide the market with a wide range of both standard products and sophisticated, customized special products. This product range includes ThermoMix® - mixing valves, ThermoVar® - thermic valves, ThermoBac - check valves, ThermoMat and ThermoKit - loading units, zone valves, filling valves, safety relief valves, temperature control valves and automatic air vents.



ELECTRONIC HEAT REGULATION

Our own range of electronic heat and temperature controllers are gathered under the family name of Smart. Simple, user friendly products that cater to our customers' needs in a smart way. This product range includes SmartComfort - heat controllers, SmartBio® - differential temperature controller, SmartSol - solar controller, SmartSolar - solar pump units and SmartStove® - biomass controller.



PREFABRICATION

In the prefabrication field, we process pipes in steel, stainless steel and copper. We also assemble components into complete units. By working closely with our customers we are able to help find their ideal solutions.



TRADE PRODUCTS

In order to be a one-stop supplier we offer, in addition to our in-house manufacture, a wide range of products from leading European manufacturers. We demand as much from our subcontractors as we do from ourselves. This means that we can be sure that all products that leave our company maintain the same high quality and are approved to national and international standards.



Loading Units for Solid Fuel Applications



LK 810 ThermoMat 2.0 G Eco

Compact loading unit with integrated low-energy circulating pump.



LK 810 ThermoMat 2.0 W Eco

Compact loading unit with integrated low-energy circulating pump.



LK 811 ThermoMat E Eco

Compact loading unit with low-energy circulating pump and integrated mixing valve.



LK 815 ThermoKit T Eco

Loading group with low-energy circulating pump.



LK 816 ThermoKit E Eco

Electronic loading group with low-energy circulating pump.

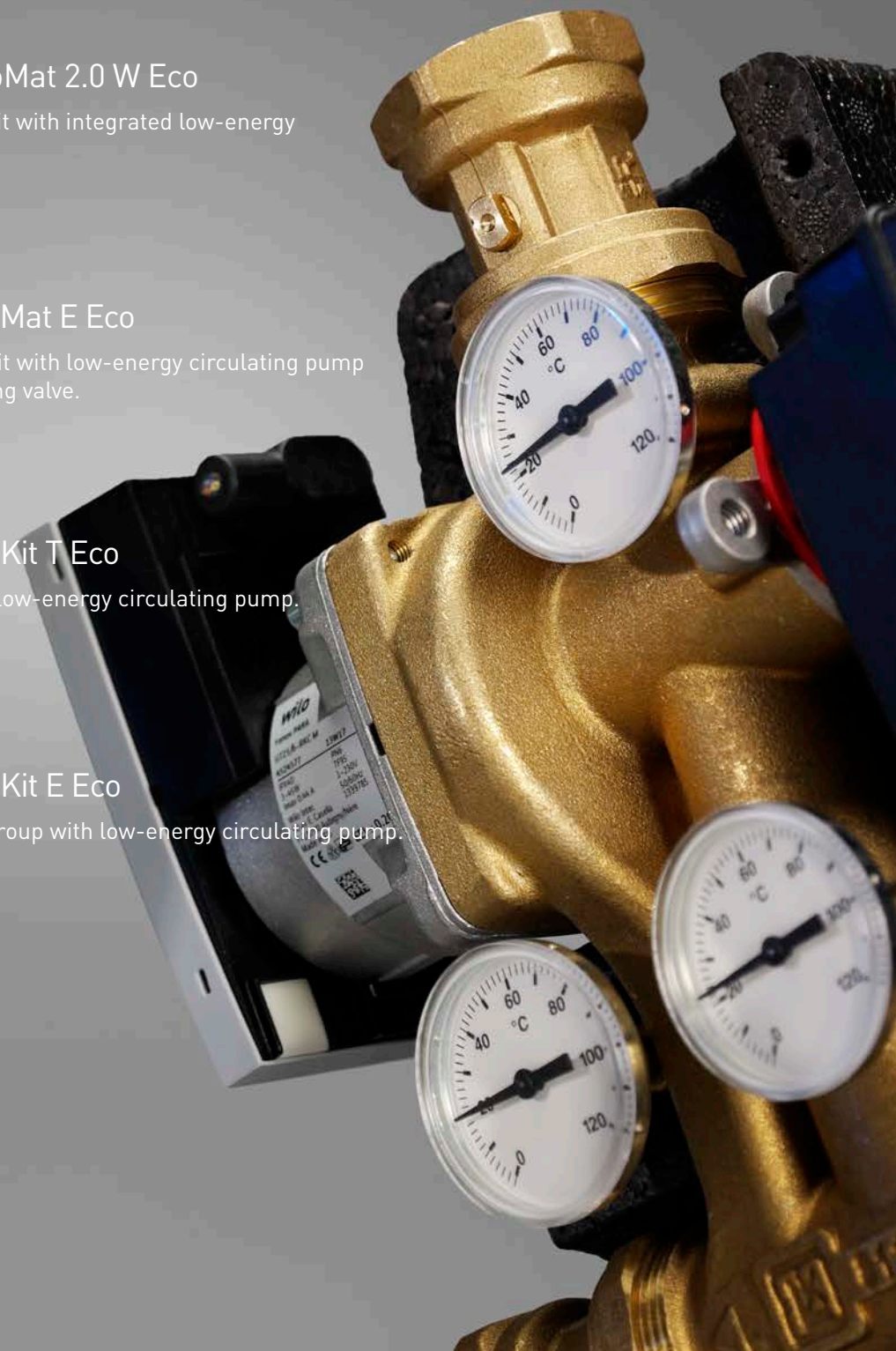

LK 810 ThermoMat 2.0 G



TECHNICAL DATA

Voltage	230 VAC 50 Hz
Power consumption	5-52 W depending on pump speed
Max. boiler efficiency	65 kW at 20 °C ΔT
Return temperature	55 °C, 60 °C, 65 °C or 70 °C
Working temperature	Min. 5 °C/Max. 110 °C
Ambient temp.	Min. 0 °C/Max. 70 °C
Max. working pressure	0.6 MPa (6 bar)
Media	Water - Glycol mixture max. 50%
Thread standard	Rp - female thread
Circulating pumps	Grundfos UPM3 AUTO L xx-70
Material, valve body	Brass EN 1982 CB753S
Material, insulation	Expanded Polypropylene EPP

LK 810 ThermoMat 2.0 G is a loading unit for heating applications with solid fuel boilers and storage tanks. The loading unit is intended to ensure a high return temperature as well as an optimal temperature stratification in the storage tank, thus increasing the efficiency of the system. Tarring and condensation are prevented which prolongs boiler life.

The LK 810 ThermoMat 2.0 G is a compact design with an integrated low-energy circulating pump and a thermic loading valve that regulates on two ports. The loading unit has three ball valves to simplify installation and maintenance, three thermometers that allow for simple control of the loading process and an insulation to minimize heat loss. The loading unit is available in two versions - with or without check valve. With a check valve the functions described under phase 4 will be obtained.

LK 810 ThermoMat 2.0 G is also available with a circulating pump that is controlled by a PWM-signal. For more information please contact our sales department.

LK 810 ThermoMat 2.0 G is installed in the return circuit between the solid fuel boiler and the storage tank. The unit should be mounted upright with the drive-shaft of the circulating pump in a horizontal position. The loading unit is reversible and can easily be adapted for mounting to the right or left of the boiler.

The loading unit normally requires no maintenance. The installation should be checked regularly. Thanks to the three ball valves any part can be changed without draining the system in case of servicing.

THE FUNCTION OF THE LOADING UNIT DURING THE DIFFERENT PHASES OF HEATING:

1. HEAT UP PHASE

The water circulates between boiler and loading unit while the temperature of the boiler is rising.

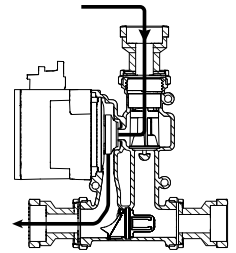

2. LOADING PHASE

The thermostatic element starts to open and allows return water from the storage tank to be mixed with supply water before it returns to the boiler. The return temperature to the boiler is kept constant.

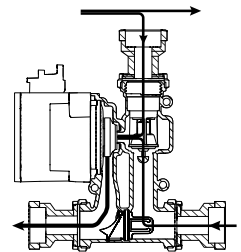

3. END PHASE

The thermostatic element is fully open and the bypass is closed. This results in an optimal transfer of heat from the boiler and the storage tank is filled with supply water.

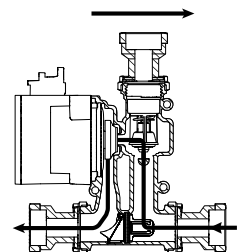

SELF-CIRCULATION WITH CHECK VALVE

Self-circulation will be obtained as soon as the fire has gone out and the circulating pump has stopped. The remaining hot water is loaded to the storage tank. In case of power failure or pump breakdown the check valve automatically opens to allow self-circulation. The check valve also stops recirculation from storage tank to boiler.

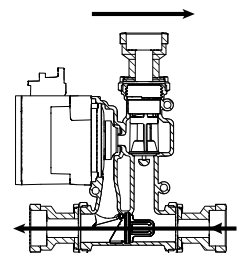

PUMP CHARACTERISTICS

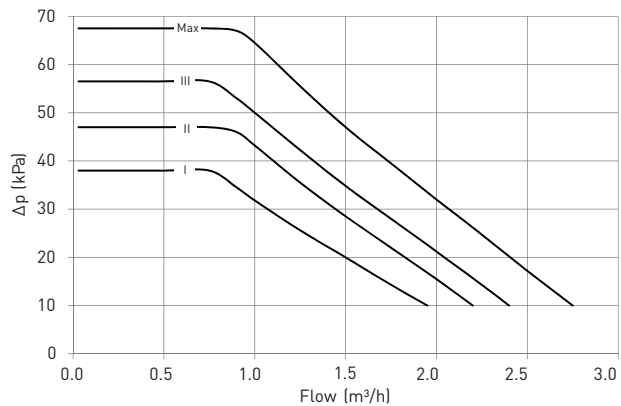

BOILER CAPACITY DIAGRAM, UPM3 AUTO L

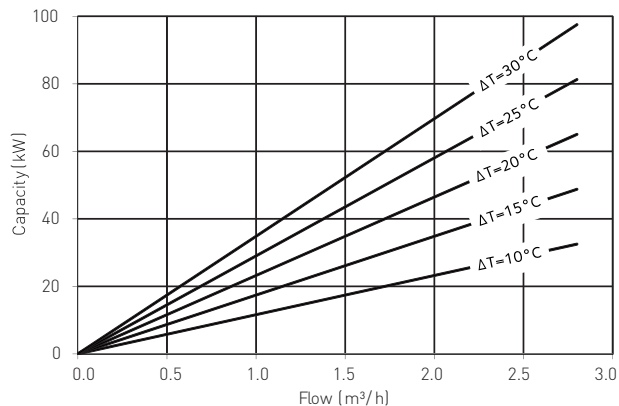

WITH CHECK VALVE

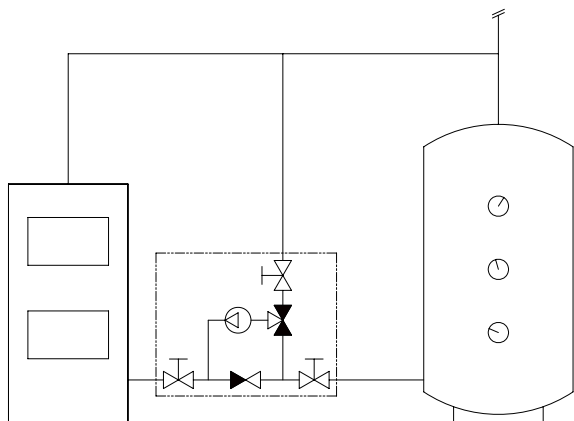

WITHOUT CHECK VALVE

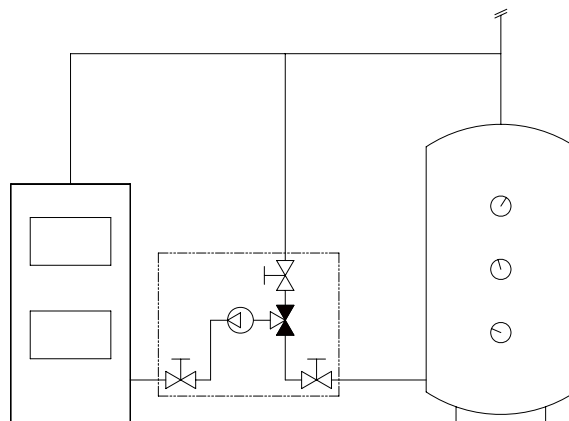

LK 810 2.0 G - Female thread

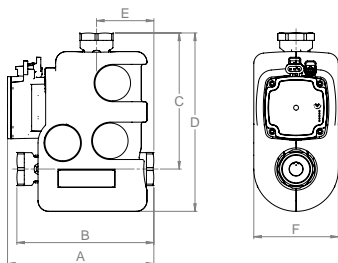

Article no.	Type	Return temperature	Dimension	A mm	B mm	C mm	D mm	E mm	F mm	Weight kg
181639	without check valve	55 °C	F 1"	208	195	195	255	82	120	4
181640	with check valve	55 °C	F 1"	208	195	195	255	82	120	4
181641	without check valve	55 °C	F 1¼"	208	195	195	255	82	120	4
181642	with check valve	55 °C	F 1¼"	208	195	195	255	82	120	4
181645	without check valve	60 °C	F 1"	208	195	195	255	82	120	4
181646	with check valve	60 °C	F 1"	208	195	195	255	82	120	4
181647	without check valve	60 °C	F 1¼"	208	195	195	255	82	120	4
181648	with check valve	60 °C	F 1¼"	208	195	195	255	82	120	4
181651	without check valve	65 °C	F 1"	208	195	195	255	82	120	4
181652	with check valve	65 °C	F 1"	208	195	195	255	82	120	4
181653	without check valve	65 °C	F 1¼"	208	195	195	255	82	120	4
181654	with check valve	65 °C	F 1¼"	208	195	195	255	82	120	4
181657	without check valve	70 °C	F 1"	208	195	195	255	82	120	4
181658	with check valve	70 °C	F 1"	208	195	195	255	82	120	4
181659	without check valve	70 °C	F 1¼"	208	195	195	255	82	120	4
181660	with check valve	70 °C	F 1¼"	208	195	195	255	82	120	4

LK 810 2.0 G - Compression fitting

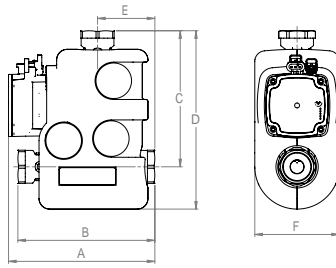

Article no.	Type	Return temperature	Dimension	A mm	B mm	C mm	D mm	E mm	F mm	Weight kg
181643	without check valve	55 °C	28 mm	208	195	195	255	82	120	4
181644	with check valve	55 °C	28 mm	208	195	195	255	82	120	4
181649	without check valve	60 °C	28 mm	208	195	195	255	82	120	4
181650	with check valve	60 °C	28 mm	208	195	195	255	82	120	4
181655	without check valve	65 °C	28 mm	208	195	195	255	82	120	4
181656	with check valve	65 °C	28 mm	208	195	195	255	82	120	4
181661	without check valve	70 °C	28 mm	208	195	195	255	82	120	4
181662	with check valve	70 °C	28 mm	208	195	195	255	82	120	4

LK 810 2.0 G - Female thread

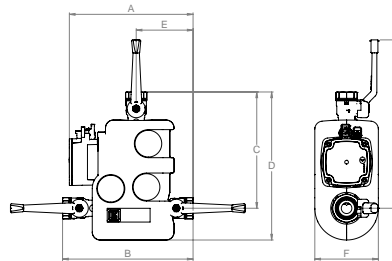

Article no.	Type	Return temperature	Dimension	A mm	B mm	C mm	D mm	E mm	F mm	G mm	Weight kg
181839	with check valve	55 °C	F 1"	234	247	222	282	108	120	300	4
181840	without check valve	55 °C	F 1"	234	247	222	282	108	120	300	4
181825	with check valve	60 °C	F 1"	234	247	222	282	108	120	300	4
181841	without check valve	60 °C	F 1"	234	247	222	282	108	120	300	4
181827	with check valve	65 °C	F 1"	234	247	220	280	108	120	300	4
181842	without check valve	65 °C	F 1"	234	247	222	282	108	120	300	4
181829	with check valve	70 °C	F 1"	234	247	222	282	108	120	300	4
181843	without check valve	70 °C	F 1"	234	247	222	282	108	120	300	4

SPARE PARTS AND ACCESSORIES

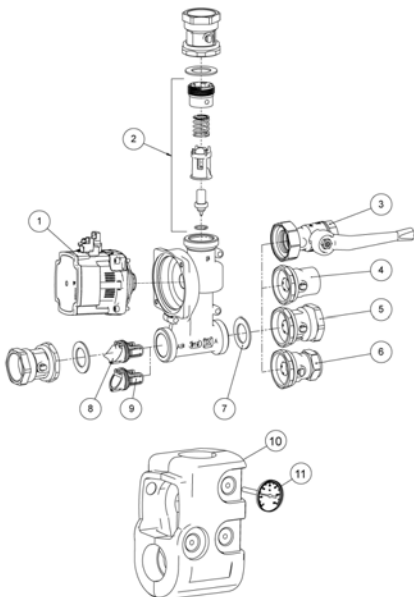

Article no.	Article	Position
187168	Pump motor Grundfos UPM3 Auto L xx-70	1
187163	Thermostatic element 55 °C	2
187164	Thermostatic element 60 °C	2
187165	Thermostatic element 65 °C	2
187166	Thermostatic element 70 °C	2
055577	Ball valve F 1" with handles, Sealing	3
187017	Ball valve F 1"	4
187018	Ball valve F 1¼"	5
187019	Ball valve 28 mm	6
013057	Sealing EPDM 44x32x2 mm	7
187021	Check valve 810 / 811	8
187022	Plug 810 / 811	9
187167	EPP Insulation	10
180352	Thermometer 120 °C	11

LK 810 ThermoMat 2.0 W



TECHNICAL DATA

Voltage	230 VAC 50 Hz
Power consumption	3-75 W depending on pump speed
Max. boiler efficiency	65 kW at 20 °C ΔT
Return temperature	55 °C, 60 °C, 65 °C or 70 °C
Working temperature	Min. 5 °C/Max. 95 °C
Ambient temp.	Min. 5 °C/Max. 60 °C
Max. working pressure	0.6 MPa (6 bar)
Media	Water - Glycol mixture max. 50%
Thread standard	Rp - female thread
Circulating pumps	Wilo Yonos PARA */7,5 RKC
Material, valve body	Brass EN 1982 CB753S
Material, insulation	Expanded Polypropylene EPP

LK 810 ThermoMat 2.0 W is a loading unit for heating applications with solid fuel boilers and storage tanks. The loading unit is intended to ensure a high return temperature as well as an optimal temperature stratification in the storage tank, thus increasing the efficiency of the system. Tarring and condensation are prevented which prolongs boiler life.

The LK 810 ThermoMat 2.0 W is a compact design with an integrated low-energy circulating pump and a thermic loading valve that regulates on two ports. The loading unit has three ball valves to simplify installation and maintenance, three thermometers that allow for simple control of the loading process and an insulation to minimize heat loss. The loading unit is available in two versions - with or without check valve. With a check valve the functions described under phase 4 will be obtained.

LK 810 ThermoMat 2.0 W is also available with a circulating pump that is controlled by a PWM-signal. For more information please contact our sales department.

LK 810 ThermoMat 2.0 W is installed in the return circuit between the solid fuel boiler and the storage tank. The unit should be mounted upright with the drive-shaft of the circulating pump in a horizontal position. The loading unit is reversible and can easily be adapted for mounting to the right or left of the boiler.

The loading unit normally requires no maintenance. The installation should be checked regularly. Thanks to the three ball valves any part can be changed without draining the system in case of servicing.

THE FUNCTION OF THE LOADING UNIT DURING THE DIFFERENT PHASES OF HEATING:

1. HEAT UP PHASE

The water circulates between boiler and loading unit while the temperature of the boiler is rising.

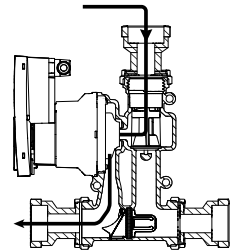

2. LOADING PHASE

The thermostatic element starts to open and allows return water from the storage tank to be mixed with supply water before it returns to the boiler. The return temperature to the boiler is kept constant.

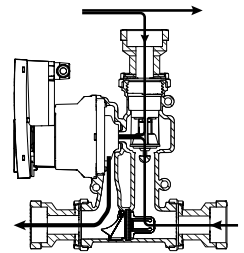

3. END PHASE

The thermostatic element is fully open and the bypass is closed. This results in an optimal transfer of heat from the boiler and the storage tank is filled with supply water.

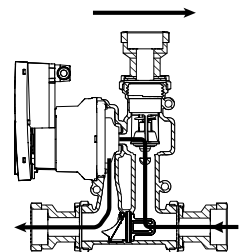

4. SELF-CIRCULATION WITH CHECK VALVE

Self-circulation will be obtained as soon as the fire has gone out and the circulating pump has stopped. The remaining hot water is loaded to the storage tank. In case of power failure or pump breakdown the check valve automatically opens to allow self-circulation. The check valve also stops recirculation from storage tank to boiler.

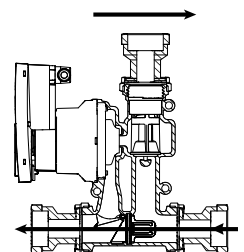

PUMP CHARACTERISTICS

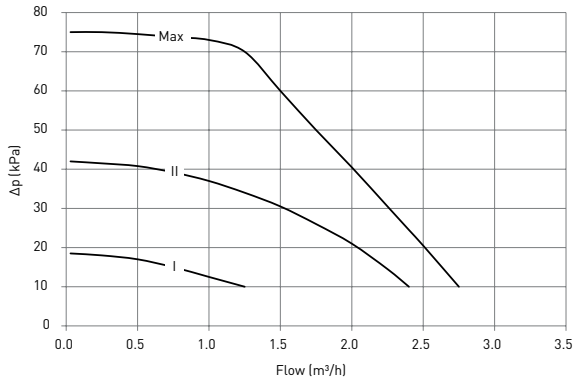

BOILER CAPACITY DIAGRAM, YONOS PARA*/7.5 RKC

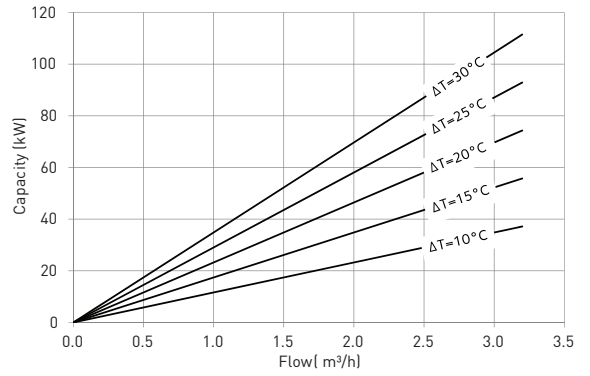

WITH CHECK VALVE

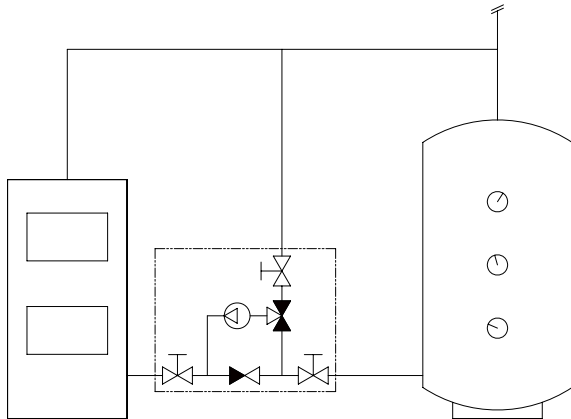

WITHOUT CHECK VALVE

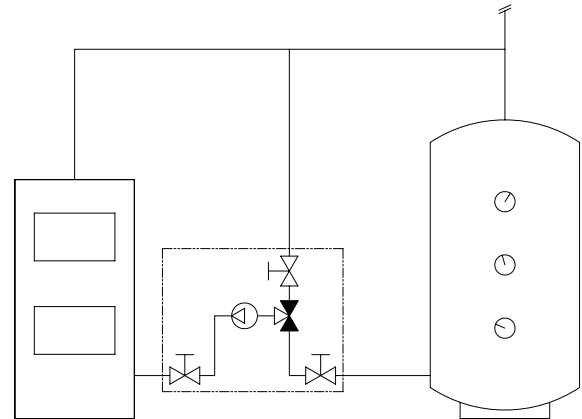

LK 810 W 2.0 - Female thread

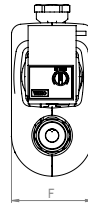
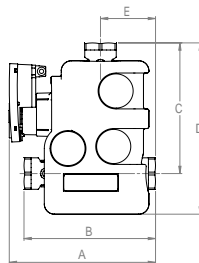

Article no.	Type	Return temperature	Dimension	A mm	B mm	C mm	D mm	E mm	F mm	Weight kg
181663	without check valve	55 °C	F 1"	216	195	195	255	82	120	4
181664	with check valve	55 °C	F 1"	216	195	195	255	82	120	4
181665	without check valve	55 °C	F 1¼"	216	195	195	255	82	120	4
181666	with check valve	55 °C	F 1¼"	216	195	195	255	82	120	4
181669	without check valve	60 °C	F 1"	216	195	195	255	82	120	4
181670	with check valve	60 °C	F 1"	216	195	195	255	82	120	4
181671	without check valve	60 °C	F 1¼"	216	195	195	255	82	120	4
181672	with check valve	60 °C	F 1¼"	216	195	195	255	82	120	4
181675	without check valve	65 °C	F 1"	216	195	195	255	82	120	4
181676	with check valve	65 °C	F 1"	216	195	195	255	82	120	4
181677	without check valve	65 °C	F 1¼"	216	195	195	255	82	120	4
181678	with check valve	65 °C	F 1¼"	216	195	195	255	82	120	4
181681	without check valve	70 °C	F 1"	216	195	195	255	82	120	4
181682	with check valve	70 °C	F 1"	216	195	195	255	82	120	4
181683	without check valve	70 °C	F 1¼"	216	195	195	255	82	120	4
181684	with check valve	70 °C	F 1¼"	216	195	195	255	82	120	4

LK 810 W 2.0 - Compression fitting

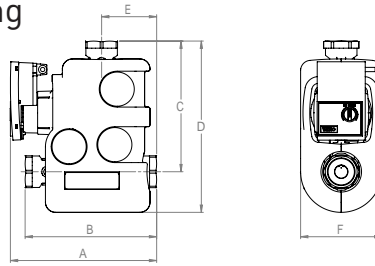

Article no.	Type	Return temperature	Dimension	A mm	B mm	C mm	D mm	E mm	F mm	Weight kg
181667	without check valve	55 °C	28 mm	216	195	195	255	82	120	4
181668	with check valve	55 °C	28 mm	216	195	195	255	82	120	4
181673	without check valve	60 °C	28 mm	216	195	195	255	82	120	4
181674	with check valve	60 °C	28 mm	216	195	195	255	82	120	4
181679	without check valve	65 °C	28 mm	216	195	195	255	82	120	4
181680	with check valve	65 °C	28 mm	216	195	195	255	82	120	4
181685	without check valve	70 °C	28 mm	216	195	195	255	82	120	4
181686	with check valve	70 °C	28 mm	216	195	195	255	82	120	4

LK 810 2.0 W - Female thread

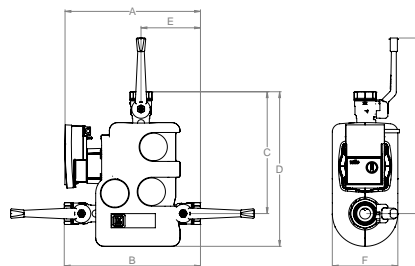

Article no.	Type	Return temperature	Dimension	A mm	B mm	C mm	D mm	E mm	F mm	G mm	Weight kg
181844	with check valve	55 °C	F 1"	248	250	222	282	108	120	302	4
181848	without check valve	55 °C	F 1"	248	250	222	282	108	120	302	4
181845	with check valve	60 °C	F 1"	248	250	222	282	108	120	302	4
181849	without check valve	60 °C	F 1"	248	250	222	282	108	120	302	4
181846	with check valve	65 °C	F 1"	248	250	222	282	108	120	302	4
181850	without check valve	65 °C	F 1"	248	250	222	282	108	120	302	4
181847	with check valve	70 °C	F 1"	248	250	222	282	108	120	302	4
181851	without check valve	70 °C	F 1"	248	250	222	282	108	120	302	4

SPARE PARTS AND ACCESSORIES

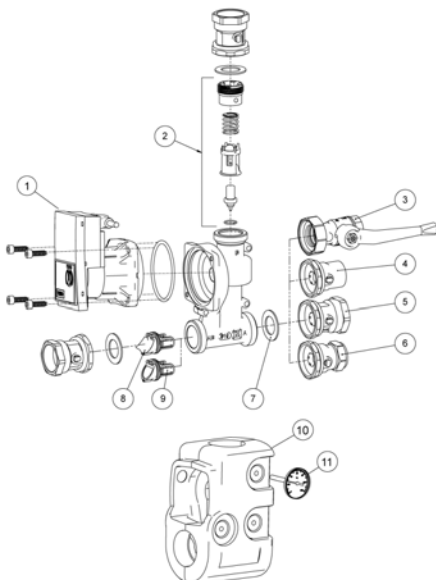

Article no.	Article	Position
187171	Wilо Yonos Para MS */7,5 RKC FS14	1
187163	Thermostatic element 55 °C	2
187164	Thermostatic element 60 °C	2
187165	Thermostatic element 65 °C	2
187166	Thermostatic element 70 °C	2
055577	Ball valve F 1" with handles, Sealing	3
187017	Ball valve F 1"	4
187018	Ball valve F 1¼"	5
187019	Ball valve 28 mm	6
013057	Sealing EPDM 44x32x2 mm	7
187021	Check valve 810 / 811	8
187022	Plug 810 / 811	9
187167	EPP Insulation	10
180352	Thermometer 120 °C	11

LK 811 ThermoMat E Eco



TECHNICAL DATA

Voltage	230 VAC 50 Hz
Power consumption	3-75 W depending on pump speed
Max. boiler efficiency	Depending on circulating pump
Return temperature	5 °C - 99 °C with LK 100 SmartComfort CT
Working temperature	Min. 5 °C/Max. 95 °C
Ambient temp.	Min. 5 °C/Max. 60 °C
Max. working pressure	0.6 MPa (6 bar)
Max. flow	Depending on circulating pump
Media	Water - Glycol mixture max. 50%
Thread standard	Rp - female thread
Circulating pumps	Wilo Yonos PARA */6 RKC, Wilو Yonos PARA */7,5 RKC
Material, valve body	Brass EN 1982 CB753S
Material, insulation	Expanded Polypropylene EPP

LK 811 ThermoMat E Eco is a loading unit for heating applications with solid fuel boilers and storage tanks. The loading unit is intended to ensure a high return temperature as well as an optimal temperature stratification in the storage tank, thus increasing the efficiency of the system. Tarring and condensation are prevented which prolongs boiler life.

The LK 811 ThermoMat E Eco is a compact design with an integrated low-energy circulating pump and a mixing valve that regulates on two ports. The loading unit has three ball valves to simplify installation and maintenance and an insulation to minimize heat loss. Three thermometers that allow for simple control of the loading process can be ordered as accessories. The loading unit is available in two versions - with or without check valve. With a check valve the functions described under phase 4 will be obtained.

LK 811 ThermoMat E Eco is available with or without an electronic temperature controller. Mounting kits for controllers of other brands are available - see section Temperature Controllers - Mounting Kits.

LK 811 ThermoMat E Eco is installed in the return circuit between the solid fuel boiler and the storage tank. The unit should be mounted upright with the drive-shaft of the circulating pump in a horizontal position. The loading unit is reversible and can easily be adapted for mounting to the right or left of the boiler.

The loading unit normally requires no maintenance. The installation should be checked regularly. Thanks to the three ball valves any part can be changed without draining the system in case of servicing.

THE FUNCTION OF THE LOADING UNIT DURING THE DIFFERENT PHASES OF HEATING:

1. HEAT UP PHASE

The water circulates between boiler and loading unit while the temperature of the boiler is rising.

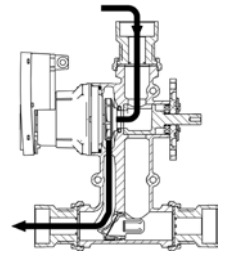

2. LOADING PHASE

The mixing valve starts to open and allows return water from the storage tank to be mixed with supply water before it returns to the boiler. The return temperature to the boiler is kept constant.

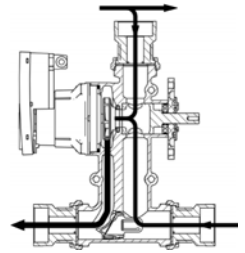

3. END PHASE

The mixing valve is fully open towards the storage tank. This results in an optimal transfer of heat from the boiler and the storage tank is filled with supply water. When the boiler has cooled the electronic controller LK 100 SmartComfort CT prevents re-circulation from storage tank to boiler.

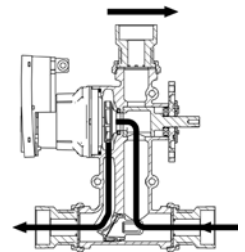

4. SELF-CIRCULATION WITH CHECK VALVE

Self-circulation will be obtained as soon as the fire has gone out and the circulating pump has stopped. The remaining hot water is loaded to the storage tank. In case of power failure or pump breakdown the check valve automatically opens to allow self-circulation. The check valve also stops recirculation from storage tank to boiler.

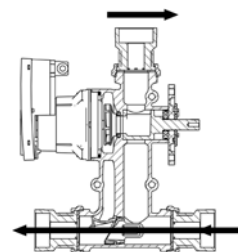

PUMP CHARACTERISTICS, YONOS PARA */6 RKC

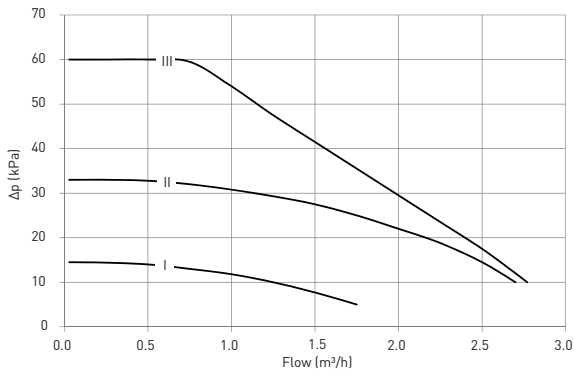

PUMP CHARACTERISTICS, YONOS PARA */7.5 RKC

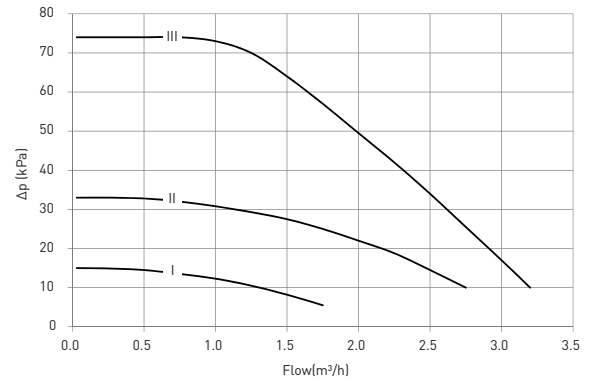

BOILER CAPACITY DIAGRAM, YONOS PARA*/6 RKC

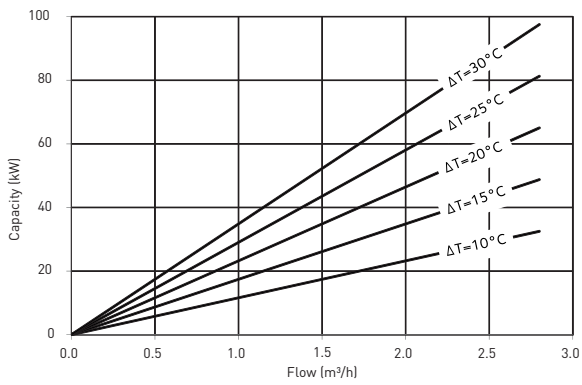

BOILER CAPACITY DIAGRAM, YONOS PARA*/7.5 RKC

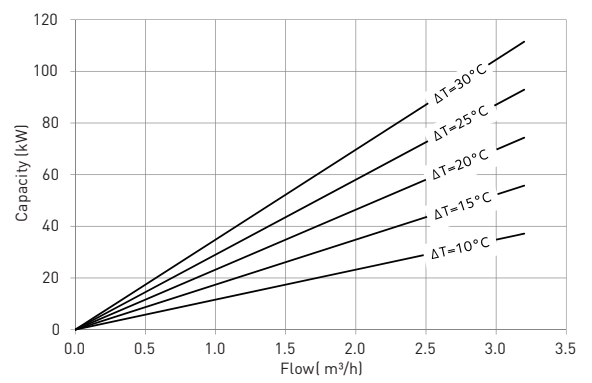

WITH CHECK VALVE

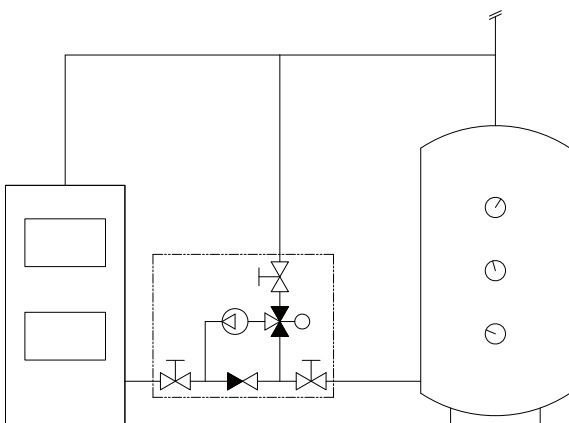

WITHOUT CHECK VALVE

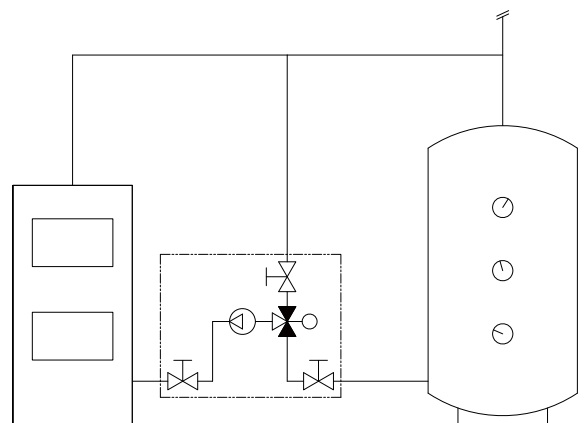

LK 811 - Wilo Yonos PARA */6 RKC - Female thread

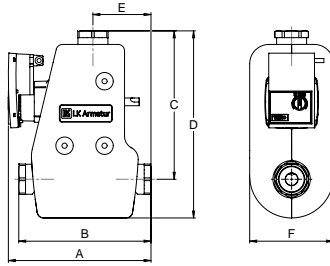

Article no.	Type	Dimension	A mm	B mm	C mm	D mm	E mm	F mm	Weight kg
181436	with check valve	F 1"	218	199	227	287	87	130	3.9
181437	without check valve	F 1"	218	199	227	287	87	130	3.9
181438	with check valve	F 1¼"	221	205	230	290	90	130	3.9
181439	without check valve	F 1¼"	221	205	230	290	90	130	3.9

LK 811 - Wilo Yonos PARA */6 RKC - Compression fitting

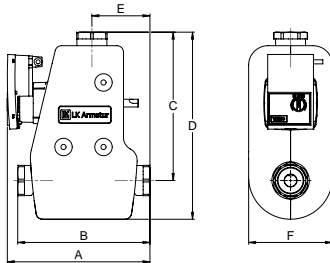

Article no.	Type	Dimension	A mm	B mm	C mm	D mm	E mm	F mm	Weight kg
181440	with check valve	28 mm	223	209	232	292	92	130	3.9
181441	without check valve	28 mm	223	209	232	292	92	130	3.9

LK 811 with LK 100 SmartComfort CT - Wilo Yonos PARA */6 RKC - Female Thread

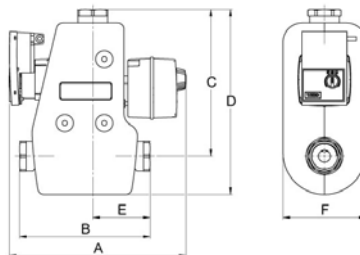

Article no.	Type	Dimension	A mm	B mm	C mm	D mm	E mm	F mm	Note	Weight kg
181526	without check valve	F 1"	280	199	227	287	87	130	adapter - EU	4.3
181527	without check valve	F 1¼"	280	205	230	290	90	130	adapter - EU	4.3
181551	with check valve	F 1"	280	199	227	287	87	130	adapter - EU	4.3
181552	with check valve	F 1¼"	280	205	230	290	90	130	adapter - EU	4.3
181530	with check valve	F 1"	280	199	227	287	87	130	adapter - UK	4.3
181531	without check valve	F 1"	280	199	227	287	87	130	adapter - UK	4.3
181532	with check valve	F 1¼"	280	205	230	290	90	130	adapter - UK	4.3
181533	without check valve	F 1¼"	280	205	230	290	90	130	adapter - UK	4.3

LK 811 with LK 100 SmartComfort CT - Wilo Yonos PARA */6 RKC - Compression Fitting

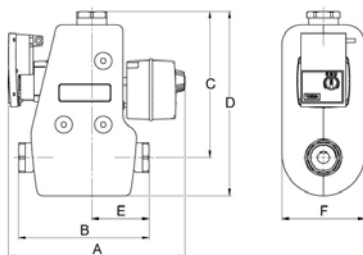

Article no.	Type	Dimension	A mm	B mm	C mm	D mm	E mm	F mm	Note	Weight kg
181528	with checkvalve	28 mm	280	209	232	292	92	130	adapter - EU	4.3
181529	without check valve	28 mm	280	209	232	292	92	130	adapter - EU	4.3
181534	with check valve	28 mm	280	209	232	292	92	130	adapter - UK	4.3
181535	without check valve	28 mm	280	209	232	292	92	130	adapter - UK	4.3

LK 811 - Wilo Yonos PARA */7.5 RKC - Female thread

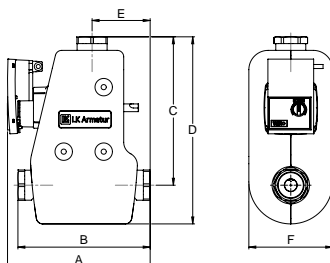

Article no.	Type	Dimension	A mm	B mm	C mm	D mm	E mm	F mm	Weight kg
181542	with check valve	F 1"	226	199	227	287	87	130	4
181543	without check valve	F 1"	226	199	227	287	87	130	4
181544	with check valve	F 1 1/4"	229	205	230	290	90	130	4
181545	without check valve	F 1 1/4"	229	205	230	290	90	130	4

LK 811 - Wilo Yonos PARA */7.5 RKC - Compression fitting

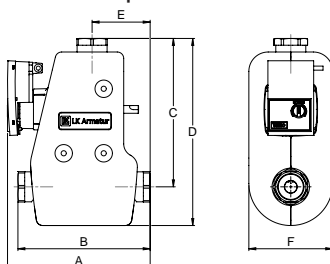

Article no.	Type	Dimension	A mm	B mm	C mm	D mm	E mm	F mm	Weight kg
181546	with check valve	28 mm	231	209	232	292	92	130	4
181547	without check valve	28 mm	231	209	232	292	92	130	4

LK 811 with 100 SmartComfort CT - Wilo Yonos PARA */7.5 RKC - Female thread

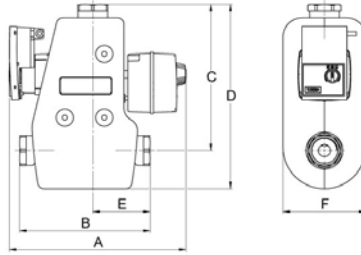

Article no.	Type	Dimension	A mm	B mm	C mm	D mm	E mm	F mm	Note	Weight kg
181558	without check valve	F 1"	288	199	227	287	87	130	adapter - EU	4.4
181559	without check valve	F 1¼"	288	205	230	290	90	130	adapter - EU	4.4
181560	with check valve	F 1"	288	199	227	287	87	130	adapter - EU	4.4
181561	with check valve	F 1¼"	288	205	230	290	90	130	adapter - EU	4.4
181564	with check valve	F 1"	288	199	227	287	87	130	adapter - UK	4.4
181565	without check valve	F 1"	288	199	227	287	87	130	adapter - UK	4.4
181566	with check valve	F 1¼"	288	205	230	290	90	130	adapter - UK	4.4
181567	without check valve	F 1¼"	288	205	230	290	90	130	adapter - UK	4.4

LK 811 with LK 100 SmartComfort CT - Wilo Yonos PARA */7.5 RKC - Compression fitting

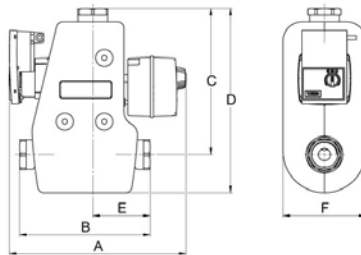

Article no.	Type	Dimension	A mm	B mm	C mm	D mm	E mm	F mm	Note	Weight kg
181562	with check valve	28 mm	288	209	232	292	92	130	adapter - EU	4.4
181563	without check valve	28 mm	288	209	232	292	92	130	adapter - EU	4.4
181568	with check valve	28 mm	288	209	232	292	92	130	adapter - UK	4.4
181569	without check valve	28 mm	288	209	232	292	92	130	adapter - UK	4.4

SPARE PARTS AND ACCESSORIES

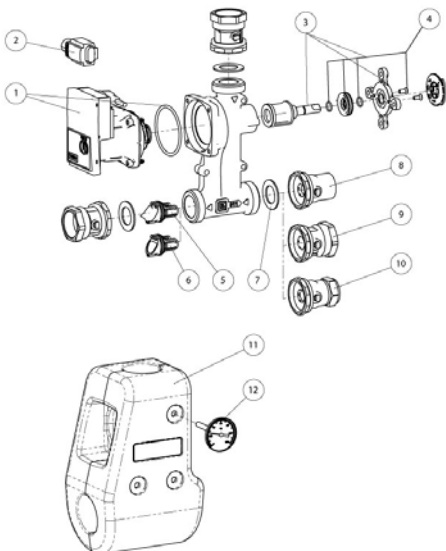

Article no.	Article	Position
187111	Pump motor Wilo Yonos PARA */6 RKC	1
187140	Pump motor Wilo Yonos PARA */7.5 RKC	1
095220	Connector	2
187110	Repair kit 811	3
187066	Sealing kit 811/840/841, DN 15-20	4
187021	Check valve 810 / 811	5
187022	Plug 810 / 811	6
013025	Gasket EPDM 1½" - Ø44 x Ø27 x 2 mm	7
187017	Ball valve F 1"	8
187018	Ball valve F 1¼"	9
187019	Ball valve 28 mm	10
187112	EPP insulation 811	11
058126	Thermometer 120 °C - Ø51 x Ø7 mm, L75 mm	12

LK 815 ThermoKit T Eco



TECHNICAL DATA

Voltage	230 VAC 50/60 Hz
Power consumption	12-140 W depending on pump speed
Max. boiler efficiency	140 kW at 20 °C ΔT
Return temperature	45 °C, 50 °C, 55 °C, 60 °C, 65 °C or 70 °C
Working temperature	Min. 5 °C/Max. 95 °C
Ambient temp.	Min. 5 °C/Max. 40 °C
Max. working pressure	1.0 MPa (10 bar)
Max. flow	5900 l/h
Media	Water - Glycol mixture max. 50%
Thread standard	Rp - female thread
Circulating pumps	Grundfos UPML 25-95 180
Material, valve body	Brass EN 1982 CB753S
Material, insulation	Expanded Polypropylene EPP

LK 815 ThermoKit T Eco is a loading group for heating applications with solid fuel boilers and storage tanks. The loading group is intended to ensure a high return temperature as well as an optimal temperature stratification in the storage tank, thus increasing the efficiency of the system. Tarring and condensation are prevented which prolongs boiler life.

LK 815 ThermoKit T Eco consists of a low-energy circulating pump an LK 823 ThermoVar thermic loading valve with insulation, a check valve, a thermometer for reading return temperature and three ball valves to simplify installation and maintenance.

LK 815 ThermoKit T Eco is installed in the return circuit between the solid fuel boiler and the storage tank. The group should be mounted with the drive-shaft of the circulating pump in a horizontal position. The loading group is reversible and can easily be adapted for mounting to the right or left of the boiler.

Thermometers are available as accessory, art. no. 181736.

The loading group normally requires no maintenance. The installation should be checked regularly. Thanks to the three ball valves any part can be changed without draining the system, if the need for servicing arise.

THE FUNCTION OF THE LOADING UNIT DURING THE DIFFERENT PHASES OF HEATING:

1. HEAT UP PHASE

The water circulates between boiler and loading group while the temperature of the boiler is rising.

2. LOADING PHASE

The thermic valve starts to open and allows return water from the storage tank to be mixed with supply water before it returns to the boiler. The return temperature to the boiler is kept constant.

3. END PHASE

The thermostatic element is fully open. This results in an optimal transfer of heat from the boiler and the storage tank is filled with supply water.

4. SELF-CIRCULATION

As soon as the fire has gone out and the circulating pump has stopped the remaining hot water in the boiler is loaded to the storage tank as long as the thermic valve remains open. When the boiler has cooled the thermic valve closes. The check valve prevents recirculation from storage tank to boiler.

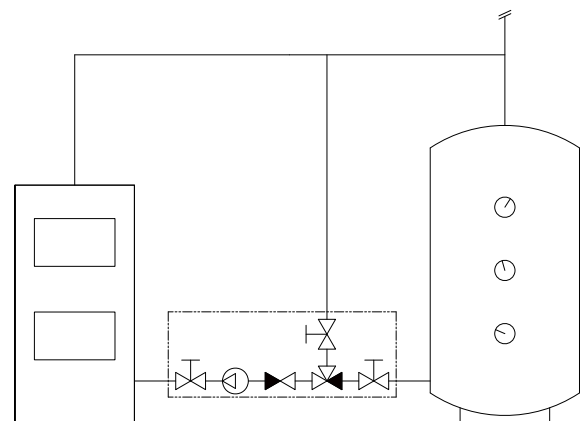

PUMP CHARACTERISTICS

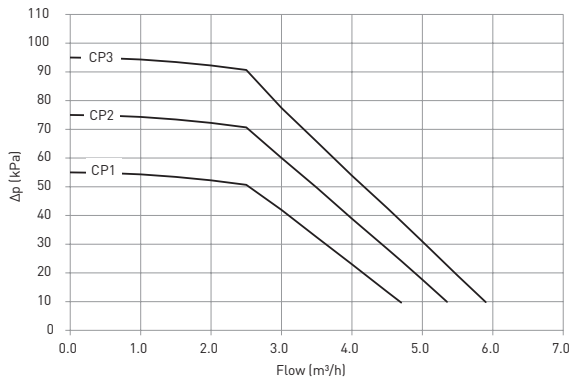

BOILER CAPACITY DIAGRAM

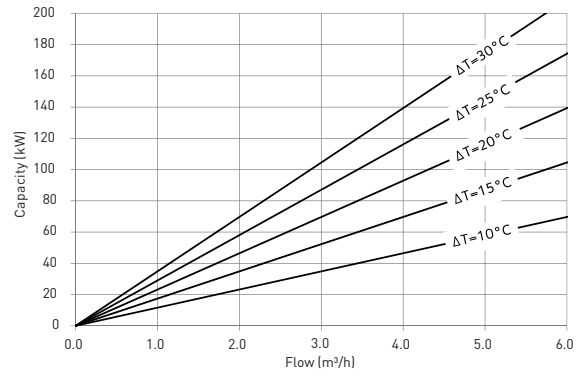

LK 815 - Grundfos UPML 25-95 - Female thread

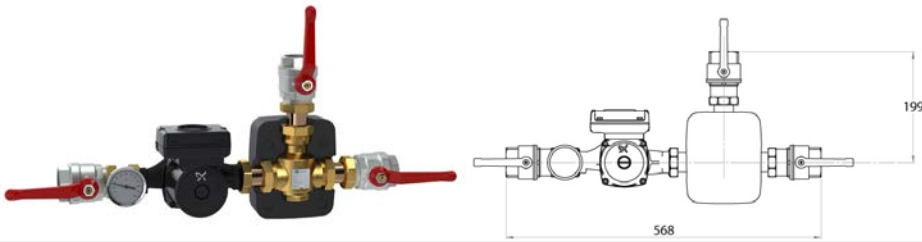

Article no.	Return temperature	Dimension	Weight kg
181572	45 °C	F 1½"	7.1
181573	50 °C	F 1½"	7.1
181574	55 °C	F 1½"	7.1
181575	60 °C	F 1½"	7.1
181576	65 °C	F 1½"	7.1
181577	70 °C	F 1½"	7.1

LK 816 ThermoKit E Eco



TECHNICAL DATA

Voltage	230 VAC 50/60 Hz
Primary voltage, adapter	100-240 VAC 50/60 Hz
Secondary voltage, adapter	24 VDC 250 mA
Power consumption	10-180 W depending on pump speed LK 100 SmartComfort CT Electronic Controller, 3 VA
Max. boiler efficiency	Dependent on circulating pump
Return temperature	5 °C - 99 °C
Working temperature	Min. 5 °C/Max. 95 °C
Ambient temp.	Min. 5 °C/Max. 40 °C
Max. working pressure	1.0 MPa (10 bar)
Angle of rotation	Temperature Controller: 90°
Torque	Temperature Controller: 5 Nm
Max. flow	Dependent on circulating pump
Media	Water - Glycol mixture max. 50%
Thread standard	Rp - female thread
Circulating pumps	Grundfos Magna 32-80 180, Grundfos UPML 25-95 180, Grundfos UPMXL 32-105 180
Operation time	140 sec.
Protection class	IP 40
Material, valve body	Brass EN 12165 CW617N
Material, insulation	Expanded Polypropylene EPP

LK 816 ThermoKit E Eco is a loading group for heating applications with solid fuel boilers and storage tanks. The loading group is intended to ensure a high return temperature as well as an optimal temperature stratification in the storage tank, thus increasing the efficiency of the system. Tarring and condensation are prevented which prolongs boiler life.

LK 816 ThermoKit E Eco is a unit consisting of a low-energy circulating pump, an LK 840 ThermoMix mixing valve, an LK 100 SmartComfort CT controller with adjustment of the lowest return temperature 5 °C - 99 °C and three ball valves to simplify installation and maintenance. Articles number 181578 and 181579 are delivered with an insulation for the mixing valve.

LK 816 ThermoKit E Eco is installed in the return circuit between the solid fuel boiler and the storage tank. The group should be mounted with the drive-shaft of the circulating pump in a horizontal position. The loading group is reversible and can easily be adapted for mounting to the right or left of the boiler.

The loading group normally requires no maintenance. The installation should be checked regularly. Thanks to the three ball valves any part can be changed without draining the system, should the need for servicing arise.

THE FUNCTION OF THE LOADING UNIT DURING THE DIFFERENT PHASES OF HEATING:

1. HEAT UP PHASE

The water circulates between boiler and loading group while the temperature of the boiler is rising.

2. LOADING PHASE

The mixing valve starts to open and allows return water from the storage tank to be mixed with supply water before it returns to the boiler. The return temperature to the boiler is kept constant.

3. END PHASE

The mixing valve is fully open towards the storage tank. This results in an optimal transfer of heat from the boiler and the storage tank is filled with supply water. When the boiler has cooled the electronic controller prevents re-circulation from storage tank to boiler.

4. SELF-CIRCULATION

In case of power failure or pump breakdown the electronic controller can be manually operated and the storage tank is loaded through self-circulation.

BOILER CAPACITY DIAGRAM

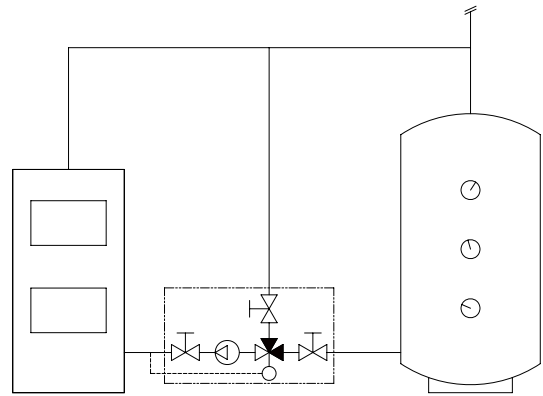
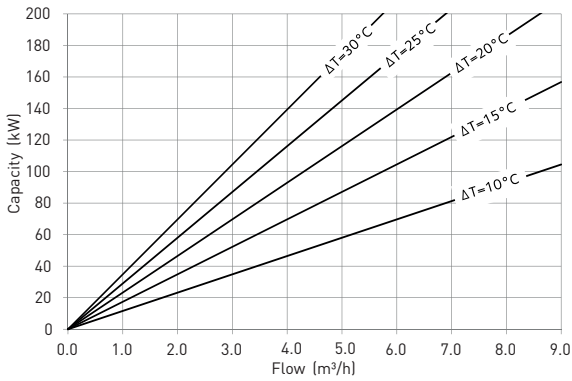

LK 816 - Grundfos UPML 25-95 - Female thread

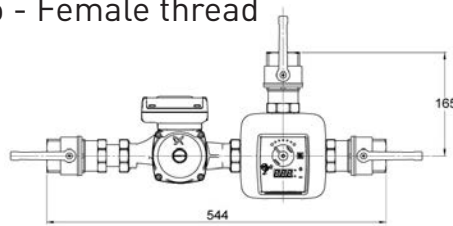

PUMP CHARACTERISTICS

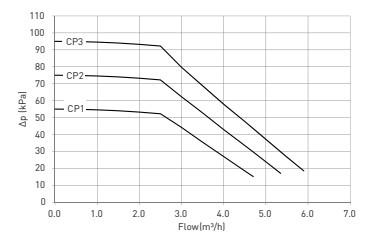

Article no.	Dimension	Note	Weight kg
181578	F 1½"	adapter - EU	7.1
181579	F 1½"	adapter - UK	7.1

LK 816 - Grundfos UPMXL 32-105 - Female thread

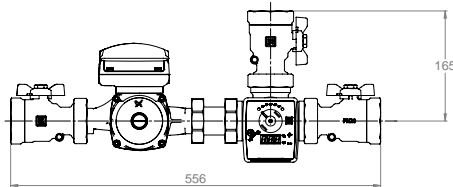

PUMP CHARACTERISTICS

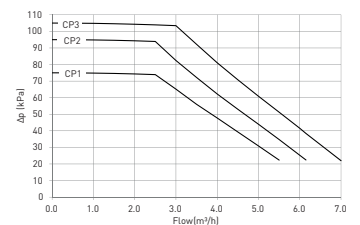

Article no.	Dimension	Note	Weight kg
181580	F 2"	adapter - EU	11.1
181581	F 2"	adapter - UK	11.1

LK 816 - Grundfos Magna 32-80 - Female thread

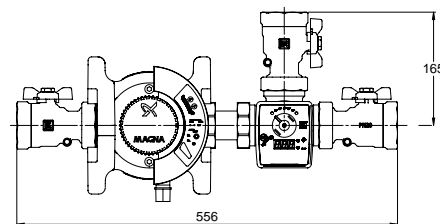

PUMP CHARACTERISTICS

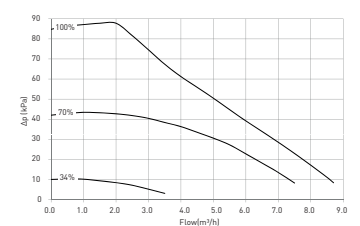

Article no.	Dimension	Note	Weight kg
181410	F 2"	adapter - EU	12.4
181582	F 2"	adapter - UK	12.4

Pump Groups



LK HydronicGroup 90

Complete pump group that is suitable for heating systems where direct supply or mixed supply is desirable.



LK 860 HydronicGroup 90

Manifold for two, optionally three, pump groups.

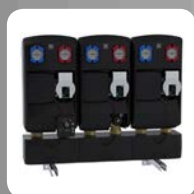

LK HydronicGroup 125

Complete pump group that is suitable for heating systems where direct supply or mixed supply is desirable.



LK 860 HydronicGroup 125

Manifold for two, optionally three, pump groups.



LK HydronicGroup 90



TECHNICAL DATA

Voltage	230 VAC 50/60 Hz
Power consumption	10-75 W depending on pump speed
Working temperature	Min. 5 °C/Max. 100 °C
Ambient temp.	Min. 5 °C/Max. 58 °C
Max. working pressure	1.0 MPa (10 bar)
Leakage	< 0,2% of Kvs at 100 kPa
Media 1	Wilo: Water - Glycol mixture max. 50%
Media 2	Taco: Water - Glycol mixture max. 30%
Thread standard	Rp - female thread, G - male thread
Circulating pumps	Wilo PARA 15-130/8-75/SC-9, Taco ES2C 15-70-130
Material, valve body	Brass EN 12165 CW617N
Material, insulation	Expanded Polypropylene EPP

LK HydronicGroup is a complete pump group that is suitable for heating systems where direct supply or mixed supply is desirable.

LK HydronicGroup comprises a high efficient circulation pump, insulation, wall mounting bracket and two ball valves with thermometer. In the model where mixed supply is desired, a three-way mixing valve is included.

A manifold for two, optionally three, pump groups is available as an accessory, see accessories and spare parts. Wall mounting bracket is not included with manifold, it must be ordered separately, see accessories and spare parts.

CAPACITY DIAGRAM

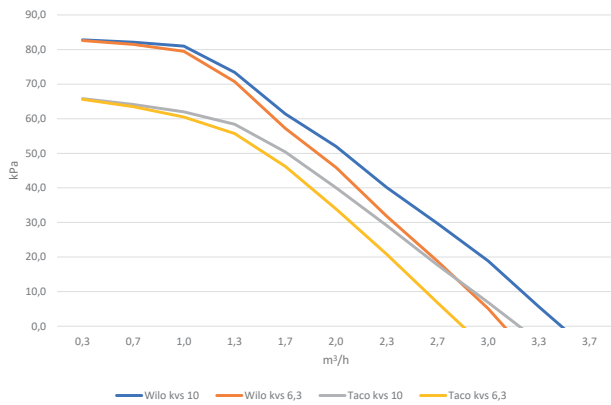

LK 861 RIGHT



LK 861 LEFT



PUMP GROUP WITH DIRECT SUPPLY

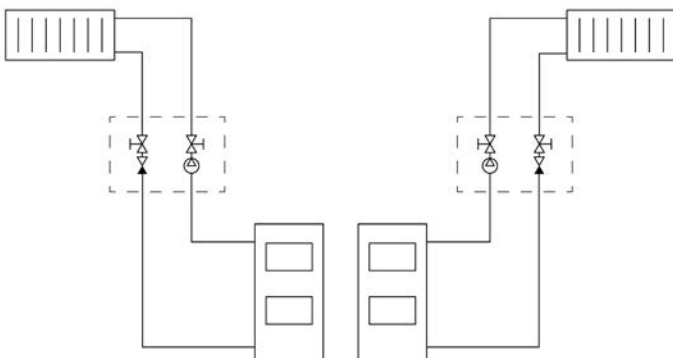

PUMP GROUP WITH MIXING VALVE

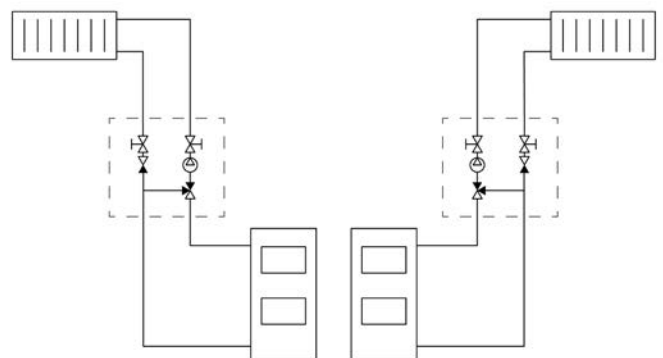

LK 860 HydronicGroup 90

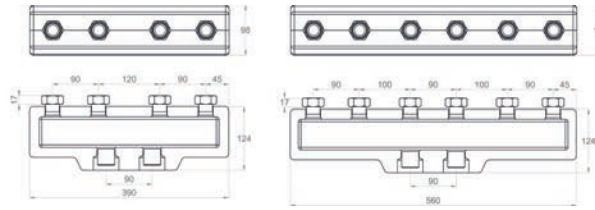

Article no.	Article	Dimension	Note	Weight kg
182125	Manifold 2 pc groups	F 1" x M 1"	0.3 MPa (3 Bar)	3.3
182126	Manifold 3 pc groups	M 1" x F 1"	0.3 MPa (3 Bar)	4.5

LK 861 HydronicGroup 90

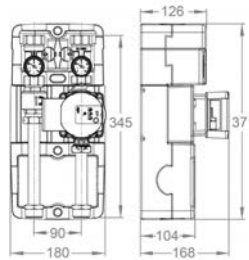

Article no.	Type	Dimension	Weight kg
299172	Wilo PARA 15-130/8-75/SC-9	F 1" x M 1"	3.7
299174	Taco ES2C 15-70-130	F 1" x M 1"	3.7

LK 862 HydronicGroup 90R

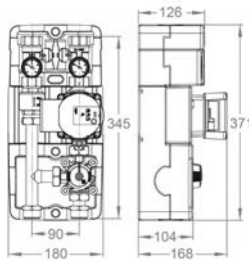

Article no.	Type	Dimension	Kvs m ³ /h	Weight kg
299171	Wilo PARA 15-130/8-75/SC-9	F 1" x M 1"	6.3 / 10	4
299173	Taco ES2C 15-70-130	F 1" x M 1"	6.3 / 10	4

SPARE PARTS AND ACCESSORIES



Article no.	Article	Position
187227	Wilo PARA 15-130/8-75/SC-9	1
187228	Taco ES2C 15-70-130	1
182125	LK 860 - Manifold 2 pc groups	2
182126	LK 860 - Manifold 3 pc groups	3
187229	Bracket for manifold	4
187230	EPP Insulation	5
187231	Ballvalve, LK 316 F1" / F1"	6
095018	Thermometer T40, 0 °C - 80 °C	7
187233	LK 850 - Mixing valve Kvs 6.3/10	8
187190	Repair kit LK 840 DN 15-20	9

LK HydronicGroup 125



TECHNICAL DATA

Voltage	230 VAC 50/60 Hz
Power consumption	10-75 W depending on pump speed
Working temperature	Min. 5 °C/Max. 100 °C
Ambient temp.	Min. 5 °C/Max. 58 °C
Max. working pressure	1.0 MPa (10 bar)
Leakage	< 0,2% of Kvs at 100 kPa
Media	Water - Glycol mixture max. 50%
Thread standard	Rp - female thread, G - male thread
Circulating pumps	Wilo PARA 25-180/8-75/SC-12
Material, valve body	Brass EN 12165 CW617N
Material, insulation	Expanded Polypropylene EPP

LK HydronicGroup is a complete pump group that is suitable for heating systems where direct supply or mixed supply is desirable.

LK HydronicGroup comprises a highly efficient circulation pump, insulation, wall mounting bracket and two ball valves with thermometer, of which the ball valve on the return side has an integrated check valve. In the type where mixed supply is desired, a three-way mixing valve is included.

A manifold for two, optionally three, pump groups is available as an accessory, see accessories and spare parts. Wall mounting bracket is not included with manifold, but must be ordered separately, see accessories and spare parts.

CAPACITY DIAGRAM

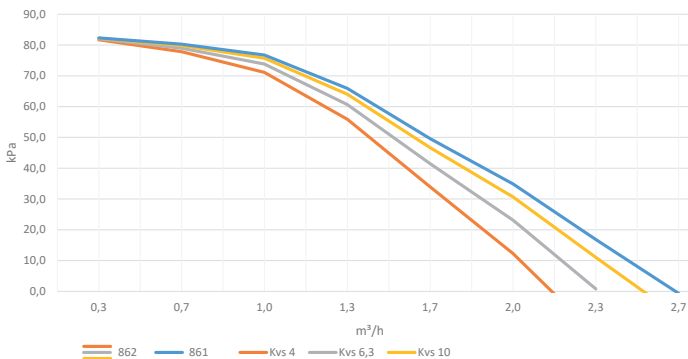

LK 861 RIGHT



LK 861 LEFT

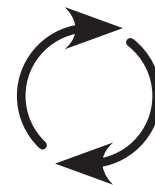

PUMP GROUP WITH DIRECT SUPPLY

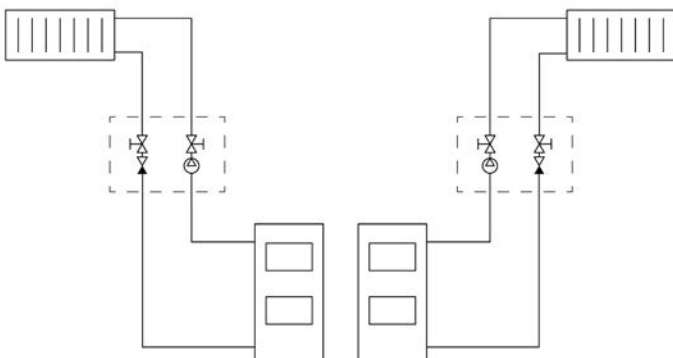

PUMP GROUP WITH MIXING VALVE

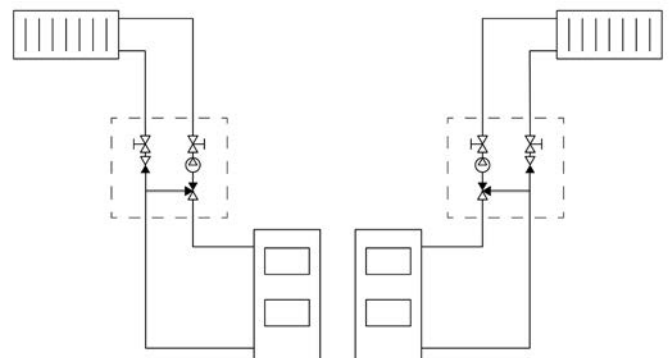

LK 860 HydronicGroup 125

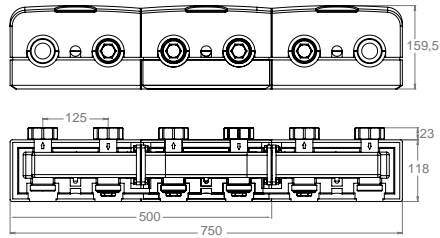

Article no.	Article	Dimension	Note	Weight kg
182047	Manifold 2 pc groups	M 1½"	0.3 MPa (3 Bar)	5.8
182048	Manifold 3 pc groups	M 1½"	0.3 MPa (3 Bar)	9.6

LK 861 HydronicGroup 125

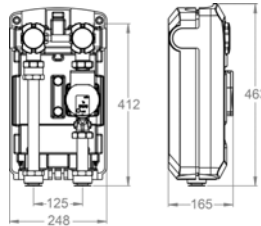

Article no.	Dimension	Weight kg
298772	F 1" x M 1½"	5.5

LK 861 HydronicGroup 125 - Whitout pump

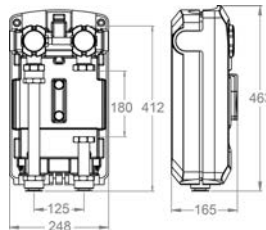

Article no.	Dimension	Weight kg
299177	F 1" x M 1½"	3.5

LK 862 HydronicGroup 125 L

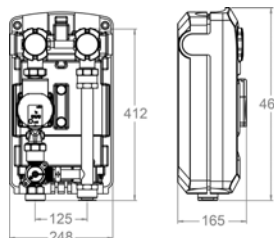

Article no.	Dimension	Kvs m³/h	Weight kg
298774	F 1" x M 1½"	4	6.2
298776	F 1" x M 1½"	6.3	6.2
299022	F 1" x M 1½"	10	6.2

LK 862 HydronicGroup 125 L - Whitout pump

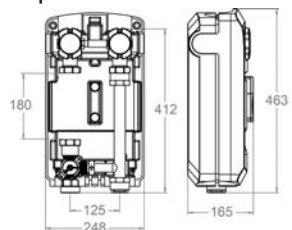

Article no.	Dimension	Kvs m³/h	Weight kg
299178	F 1" x M 1½"	4	4.2
299179	F 1" x M 1½"	6.3	4.2
299180	F 1" x M 1½"	10	4.2

LK 862 HydronicGroup 125 R

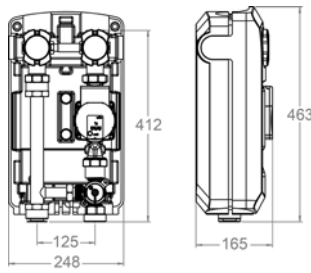

Article no.	Dimension	Kvs m ³ /h	Weight kg
298773	F 1" x M 1½"	4	6.2
298775	F 1" x M 1½"	6.3	6.2
298777	F 1" x M 1½"	10	6.2

LK 862 HydronicGroup 125 R - Whitout pump

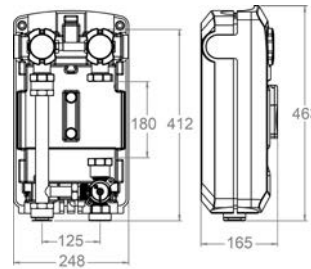

Article no.	Dimension	Kvs m ³ /h	Weight kg
299181	F 1" x M 1½"	4	4.2
299182	F 1" x M 1½"	6.3	4.2
299183	F 1" x M 1½"	10	4.2

SPARE PARTS AND ACCESSORIES

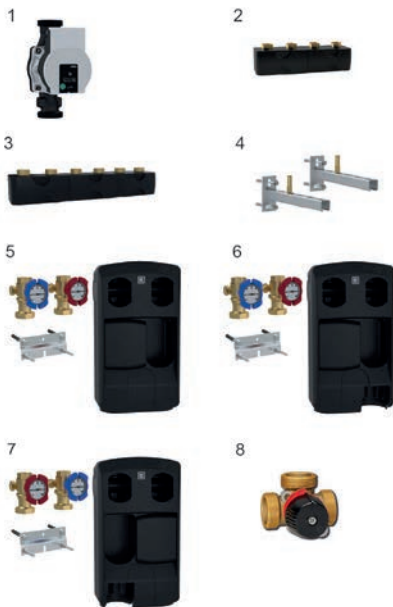

Article no.	Article	Position
187203	Pump head Wilo PARA 25-180/8-75/SC-12	1
182047	LK 860 - Manifold 2 pc groups	2
182048	LK 860 - Manifold 3 pc groups	3
182049	Bracket for manifold	4
187204	LK 861 EPP Insulation, ballvalves, bracket	5
187205	LK 862-R EPP Insulation, ballvalves, bracket	6
187206	LK 862-L EPP Insulation, ballvalves, bracket	7
181920	Mixing Valve LK 840 Kvs 4 (for 298773, 298774)	8
181921	Mixing Valve LK 840 Kvs 6,3 (for 298775, 298776)	8
181922	Mixing Valve LK 840 Kvs 10 (for 298777, 299022)	8
187188	Sealing kit LK 840/841 DN 25	9
187187	Sealing kit LK 840/841 DN 15-20	9
187191	Repair kit 840 DN 25	10
187190	Repair kit LK 840 DN 15-20	10

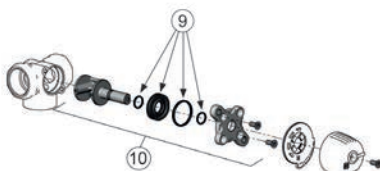

Thermic Valves and Check Valves



LK 820 ThermoVar®

3-way thermic loading valve made of brass.



LK 821 ThermoVar®

3-way thermic zone valve made of brass.



LK 823 ThermoVar®

3-way thermic loading valve made of brass.



LK 822 ThermoBac

3-way check valve made of brass.



LK Isolering

Insulation for ThermoVar®, ThermoBac ThermoMix® and MultiZone.



LK 820 ThermoVar®



TECHNICAL DATA

Opening temperature	45 °C, 55 °C, 61 °C, 66 °C, 72 °C or 80 °C
Working temperature	(45 °C - 55 °C) Min. 5 °C/Max. 95 °C (61 °C - 80 °C) Min. 5 °C/Max. 110 °C
Ambient temp.	Min. 5 °C/Max. 60 °C
Max. working pressure	1.0 MPa (10 bar)
Max. differential pressure	50 kPa (0,5 bar)
Media	Water - Glycol mixture max. 50%
Thread standard	Rp - female thread, G - male thread
Material, valve body	Brass EN 12165 CW617N
Material, external cover	Brass EN 12165 CW617N
Material, sealing	EPDM

LK 820 ThermoVar® is a 3-way thermic loading valve for solid fuel/storage tank installations. The valve is intended to ensure both an optimal temperature stratification in the storage tank and a high return temperature to the boiler, thus increasing the efficiency of the system. Tarring and condensation are prevented which prolongs boiler life.

LK 820 can be equipped with an insulation - see under Accessories. For more information, please see the product sheet for insulations.

The valve can be mounted at any angle. LK 820 ThermoVar® can easily be adapted for right- or left-hand mounting. The valve can be installed in three different positions.

In the standard version the valve is intended for installation in position II. It can easily be adapted for installation in position I. For delivery of valves intended for installation in position III, please contact our Sales Department.

POSITION I

As soon as the boiler temperature has reached the selected opening temperature, the thermic valve allows hot water to load to the storage tank. Return water from the storage tank is mixed with supply water before it circulates back into the boiler. The loading temperature is at least the selected opening temperature.

A balancing valve should be installed in the circuit between boiler and loading valve.

The installation should be equipped with an LK 822 Thermo-Bac check valve to prevent self-circulation from storage tank to boiler after the fire has gone out. In case of power failure or pump breakdown the check valve automatically opens for self-circulation.

The circulating pump should be controlled by a thermostat that measures the boiler's water or flue gas temperature.

POSITION II

As soon as the boiler temperature has reached the selected opening temperature, the thermic valve allows return water from the storage tank to mix with supply water before it circulates back into the boiler. The return temperature is at least the selected opening temperature.

A balancing valve should be installed in the circuit between boiler and loading valve.

The circulating pump should be controlled by a thermostat that measures the boiler's water or flue gas temperature.

POSITION III

As soon as the boiler temperature has reached the selected opening temperature, the thermic valve allows return water from the storage tank to mix with supply water before it circulates back into the boiler. The return temperature is at least the selected opening temperature.

A balancing valve should be installed in the circuit between boiler and loading valve.

The installation should be equipped with an LK 822 Thermo-Bac check valve to prevent self-circulation from storage tank to boiler after the fire has gone out. In case of power failure or pump breakdown the check valve opens automatically for self-circulation.

The circulating pump should be controlled by a thermostat that measures the boiler's water or flue gas temperature.

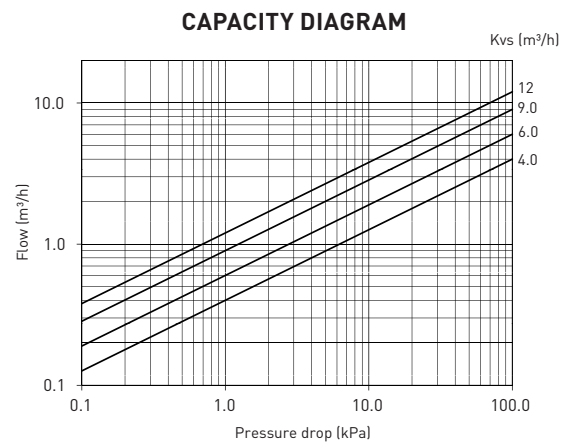
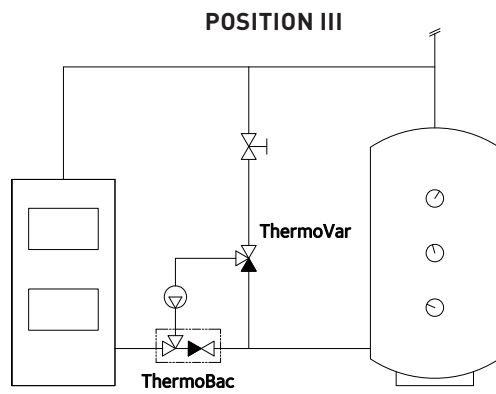
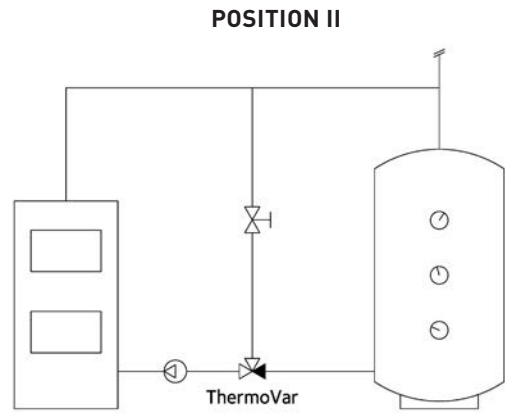
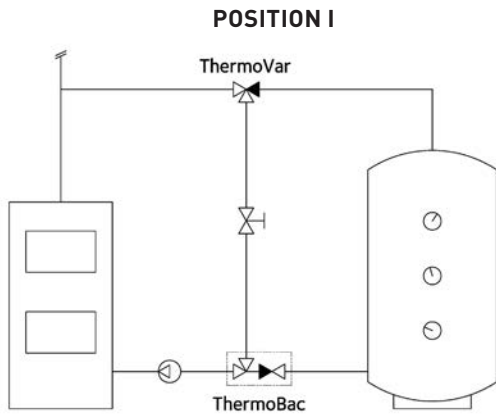

LK 820 - Female thread

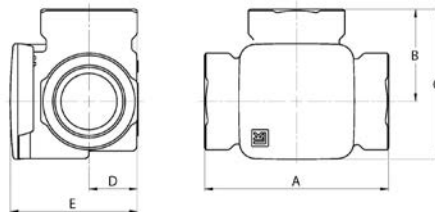

Article no.	Opening temperature	Dimension	Kvs m ³ /h	A mm	B mm	C mm	D mm	E mm	Weight kg
180491	45 °C	F 1/2"	4.0	80	40	66	21	35	0.7
180492	45 °C	F 3/4"	6.0	80	40	66	21	35	0.7
180493	45 °C	F 1"	9.0	82	41	67	21	35	0.7
180494	45 °C	F 1 1/4"	12	84	42	68	24	39	0.8
180499	55 °C	F 1/2"	4.0	80	40	66	21	35	0.7
180500	55 °C	F 3/4"	6.0	80	40	66	21	35	0.7
180501	55 °C	F 1"	9.0	82	41	67	21	35	0.7
180502	55 °C	F 1 1/4"	12	84	42	68	24	39	0.8
180507	61 °C	F 1/2"	4.0	80	40	66	21	35	0.7
180508	61 °C	F 3/4"	6.0	80	40	66	21	35	0.7
180509	61 °C	F 1"	9.0	82	41	67	21	35	0.7
180510	61 °C	F 1 1/4"	12	84	42	68	24	39	0.8

LK 820 - Female thread

Article no.	Opening temperature	Dimension	Kvs m ³ /h	A mm	B mm	C mm	D mm	E mm	Weight kg
180515	66 °C	F 1/2"	4.0	80	40	66	21	35	0.7
180516	66 °C	F 3/4"	6.0	80	40	66	21	35	0.7
180517	66 °C	F 1"	9.0	82	41	67	21	35	0.7
180518	66 °C	F 1 1/4"	12	84	42	68	24	39	0.8
180523	72 °C	F 1/2"	4.0	80	40	66	21	35	0.7
180524	72 °C	F 3/4"	6.0	80	40	66	21	35	0.7
180525	72 °C	F 1"	9.0	82	41	67	21	35	0.7
180526	72 °C	F 1 1/4"	12	84	42	68	24	39	0.8
180531	80 °C	F 1/2"	4.0	80	40	66	21	35	0.7
180532	80 °C	F 3/4"	6.0	80	40	66	21	35	0.7
180533	80 °C	F 1"	9.0	82	41	67	21	35	0.7
180534	80 °C	F 1 1/4"	12	84	42	68	24	39	0.8

LK 820 - Male thread

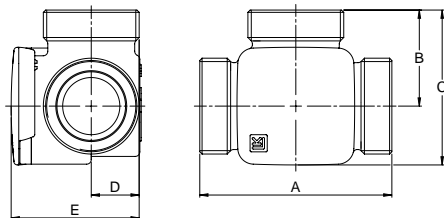

Article no.	Opening temperature	Dimension	Kvs m ³ /h	A mm	B mm	C mm	D mm	E mm	Weight kg
180495	45 °C	M 3/4"	4.0	80	40	66	21	35	0.7
180496	45 °C	M 1"	6.0	80	40	66	21	35	0.7
180497	45 °C	M 1 1/4"	9.0	84	42	68	21	35	0.7
180498	45 °C	M 1 1/2"	12	84	42	68	24	39	0.8
180503	55 °C	M 3/4"	4.0	80	40	66	21	35	0.7
180504	55 °C	M 1"	6.0	80	40	66	21	35	0.7
180505	55 °C	M 1 1/4"	9.0	84	42	68	21	35	0.7
180506	55 °C	M 1 1/2"	12	84	42	68	24	39	0.8
180511	61 °C	M 3/4"	4.0	80	40	66	21	35	0.7
180512	61 °C	M 1"	6.0	80	40	66	21	35	0.7
180513	61 °C	M 1 1/4"	9.0	84	42	68	21	35	0.7
180514	61 °C	M 1 1/2"	12	84	42	68	24	39	0.8
180519	66 °C	M 3/4"	4.0	80	40	66	21	35	0.7
180520	66 °C	M 1"	6.0	80	40	66	21	35	0.7
180521	66 °C	M 1 1/4"	9.0	84	42	68	21	35	0.7
180522	66 °C	M 1 1/2"	12	84	42	68	24	39	0.8
180527	72 °C	M 3/4"	4.0	80	40	66	21	35	0.7
180528	72 °C	M 1"	6.0	80	40	66	21	35	0.7
180529	72 °C	M 1 1/4"	9.0	84	42	68	21	35	0.7
180530	72 °C	M 1 1/2"	12	84	42	68	24	39	0.8
180535	80 °C	M 3/4"	4.0	80	40	66	21	35	0.7
180536	80 °C	M 1"	6.0	80	40	66	21	35	0.7
180537	80 °C	M 1 1/4"	9.0	84	42	68	21	35	0.7
180538	80 °C	M 1 1/2"	12	84	42	68	24	39	0.8

LK 820 - Compression fitting

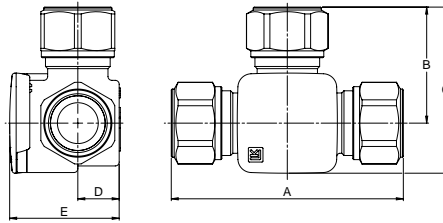

Article no.	Opening temperature	Dimension	Kvs m ³ /h	A mm	B mm	C mm	D mm	E mm	Weight kg
181118	45 °C	15 mm	4.0	114	57	83	21	35	0.8
181119	45 °C	22 mm	6.0	114	57	83	21	35	0.8
181120	45 °C	28 mm	9.0	120	60	86	21	35	1.0
181121	55 °C	15 mm	4.0	114	57	83	21	35	0.8
181122	55 °C	22 mm	6.0	114	57	83	21	35	0.8
181123	55 °C	28 mm	9.0	120	60	86	21	35	1.0
181124	61 °C	15 mm	4.0	114	57	83	21	35	0.8
181125	61 °C	22 mm	6.0	114	57	83	21	35	0.8
181126	61 °C	28 mm	9.0	120	60	86	21	35	1.0
181133	66 °C	15 mm	4.0	114	57	83	21	35	0.8
181134	66 °C	22 mm	6.0	114	57	83	21	35	0.8
181135	66 °C	28 mm	9.0	120	60	86	21	35	1.0
181127	72 °C	15 mm	4.0	114	57	83	21	35	0.8
181128	72 °C	22 mm	6.0	114	57	83	21	35	0.8
181129	72 °C	28 mm	9.0	120	60	86	21	35	1.0
181130	80 °C	15 mm	4.0	114	57	83	21	35	0.8
181131	80 °C	22 mm	6.0	114	57	83	21	35	0.8
181132	80 °C	28 mm	9.0	120	60	86	21	35	1.0

SPARE PARTS AND ACCESSORIES

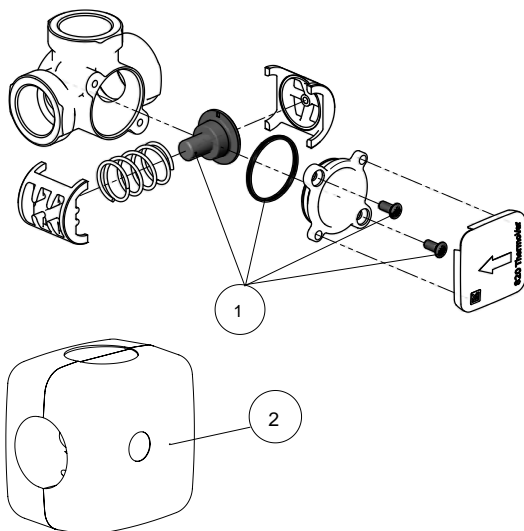

Article no.	Article	Position
187025	Thermostatic element 820, 45 °C	1
187026	Thermostatic element 820, 55 °C	1
187027	Thermostatic element 820, 61 °C	1
187028	Thermostatic element 820, 66 °C	1
187029	Thermostatic element 820, 72 °C	1
187030	Thermostatic element 820, 80 °C	1
187107	Insulation, DN 15-20	2
187108	Insulation, DN 25-32	2

LK 821 ThermoVar®



TECHNICAL DATA

Opening temperature	45 °C, 55 °C, 61 °C, 66 °C, 72 °C or 80 °C
Working temperature	(45 °C - 55 °C) Min. 5 °C/Max. 95 °C (61 °C - 80 °C) Min. 5 °C/Max. 110 °C
Ambient temp.	Min. 5 °C/Max. 60 °C
Max. working pressure	1.0 MPa (10 bar)
Max. differential pressure	50 kPa (0.5 bar)
Media	Water - Glycol mixture max. 50%
Thread standard	Rp - female thread, G - male thread
Material, valve body	Brass EN 12165 CW617N
Material, external cover	Brass EN 12165 CW617N
Material, sealing	EPDM

LK 821 ThermoVar® 3-way thermic zone valve is designed to change the direction of flow of the media in heating systems. The valve is controlled by the temperature of the media. With an LK 821 ThermoVar® installed in, for example, a solar heating system an optimal stratification in the storage tank is obtained.

LK 821 can be equipped with an insulation - see under Accessories. For more information, please see the product sheet for insulations.

The valve can be mounted at any angle. LK 821 ThermoVar® can easily be adapted for right- or left-hand mounting.

CAPACITY DIAGRAM

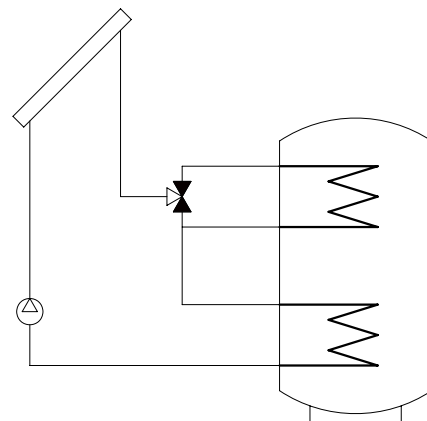
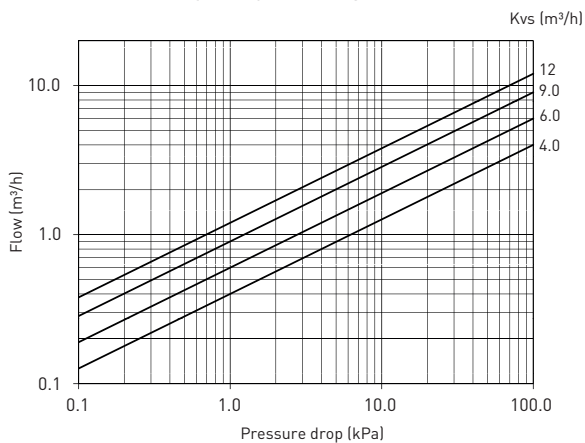

LK 821 - Female thread

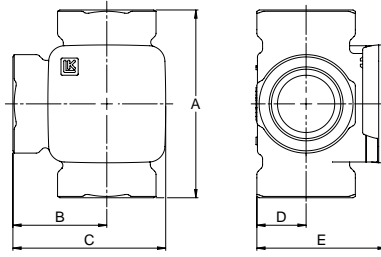

Article no.	Opening temperature	Dimension	Kvs m ³ /h	A mm	B mm	C mm	D mm	E mm	Weight kg
180539	45 °C	F 1/2"	4.0	80	40	66	21	35	0.7
180540	45 °C	F 3/4"	6.0	80	40	66	21	35	0.8
180541	45 °C	F 1"	9.0	82	41	67	21	35	0.9
180542	45 °C	F 1 1/4"	12	84	42	68	24	39	1.0
180547	55 °C	F 1/2"	4.0	80	40	66	21	35	0.7
180548	55 °C	F 3/4"	6.0	80	40	66	21	35	0.8
180549	55 °C	F 1"	9.0	82	41	67	21	35	0.9
180550	55 °C	F 1 1/4"	12	84	42	68	24	39	1.0
180555	61 °C	F 1/2"	4.0	80	40	66	21	35	0.7
180556	61 °C	F 3/4"	6.0	80	40	66	21	35	0.8
180557	61 °C	F 1"	9.0	82	41	67	21	35	0.9
180558	61 °C	F 1 1/4"	12	84	42	68	24	39	1.0
180563	66 °C	F 1/2"	4.0	80	40	66	21	35	0.7
180564	66 °C	F 3/4"	6.0	80	40	66	21	35	0.8
180565	66 °C	F 1"	9.0	82	41	67	21	35	0.9
180566	66 °C	F 1 1/4"	12	84	42	68	24	39	1.0
180571	72 °C	F 1/2"	4.0	80	40	66	21	35	0.7
180572	72 °C	F 3/4"	6.0	80	40	66	21	35	0.8
180573	72 °C	F 1"	9.0	82	41	67	21	35	0.9
180574	72 °C	F 1 1/4"	12	84	42	68	24	39	1.0
180579	80 °C	F 1/2"	4.0	80	40	66	21	35	0.7
180580	80 °C	F 3/4"	6.0	80	40	66	21	35	0.8
180581	80 °C	F 1"	9.0	82	41	67	21	35	0.9
180582	80 °C	F 1 1/4"	12	84	42	68	24	39	1.0

LK 821 - Male thread

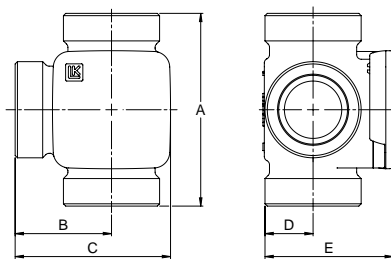

Article no.	Opening temperature	Dimension	Kvs m ³ /h	A mm	B mm	C mm	D mm	E mm	Weight kg
180543	45 °C	M ¾"	4.0	80	40	66	21	35	0.7
180544	45 °C	M 1"	6.0	80	40	66	21	35	0.8
180545	45 °C	M 1¼"	9.0	84	42	68	21	35	0.9
180546	45 °C	M 1½"	12	84	42	68	24	39	1.0
180551	55 °C	M ¾"	4.0	80	40	66	21	35	0.7
180552	55 °C	M 1"	6.0	80	40	66	21	35	0.8
180553	55 °C	M 1¼"	9.0	84	42	68	21	35	0.9
180554	55 °C	M 1½"	12	84	42	68	24	39	1.0
180559	61 °C	M ¾"	4.0	80	40	66	21	35	0.7
180560	61 °C	M 1"	6.0	80	40	66	21	35	0.8
180561	61 °C	M 1¼"	9.0	84	42	68	21	35	0.9
180562	61 °C	M 1½"	12	84	42	68	24	39	1.0
180567	66 °C	M ¾"	4.0	80	40	66	21	35	0.7
180568	66 °C	M 1"	6.0	80	40	66	21	35	0.8
180569	66 °C	M 1¼"	9.0	84	42	68	21	35	0.9
180570	66 °C	M 1½"	12	84	42	68	24	39	1.0
180575	72 °C	M ¾"	4.0	80	40	66	21	35	0.7
180576	72 °C	M 1"	6.0	80	40	66	21	35	0.8
180577	72 °C	M 1¼"	9.0	84	42	68	21	35	0.9
180578	72 °C	M 1½"	12	84	42	68	24	39	1.0
180583	80 °C	M ¾"	4.0	80	40	66	21	35	0.7
180584	80 °C	M 1"	6.0	80	40	66	21	35	0.8
180585	80 °C	M 1¼"	9.0	84	42	68	21	35	0.9
180586	80 °C	M 1½"	12	84	42	68	24	39	1.0

LK 821 - Compression fitting

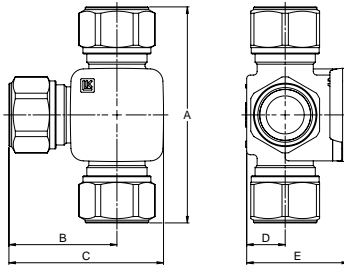

Article no.	Opening temperature	Dimension	Kvs m ³ /h	A mm	B mm	C mm	D mm	E mm	Weight kg
180901	45 °C	15 mm	4.0	114	57	83	21	35	0.8
180903	45 °C	22 mm	6.0	114	57	83	21	35	0.8
180904	45 °C	28 mm	9.0	120	60	86	21	35	1.0
180905	55 °C	15 mm	4.0	114	57	83	21	35	0.8
180907	55 °C	22 mm	6.0	114	57	83	21	35	0.8
180908	55 °C	28 mm	9.0	120	60	86	21	35	1.0
180909	61 °C	15 mm	4.0	114	57	83	21	35	0.8
180911	61 °C	22 mm	6.0	114	57	83	21	35	0.8
180912	61 °C	28 mm	9.0	120	60	86	21	35	1.0
180913	66 °C	15 mm	4.0	114	57	83	21	35	0.8
180915	66 °C	22 mm	6.0	114	57	83	21	35	0.8
180916	66 °C	28 mm	9.0	120	60	86	21	35	1.0
180917	72 °C	15 mm	4.0	114	57	83	21	35	0.8
180919	72 °C	22 mm	6.0	114	57	83	21	35	0.8
180920	72 °C	28 mm	9.0	120	60	86	21	35	1.0
180921	80 °C	15 mm	4.0	114	57	83	21	35	0.8
180923	80 °C	22 mm	6.0	114	57	83	21	35	0.8
180924	80 °C	28 mm	9.0	120	60	86	21	35	1.0

SPARE PARTS AND ACCESSORIES

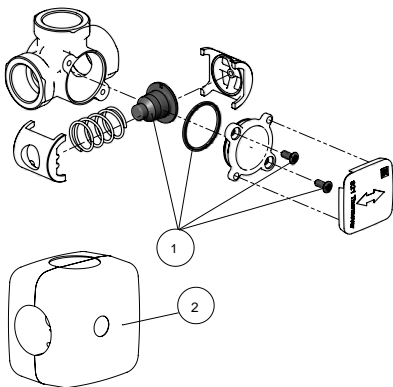

Article no.	Article	Position
187031	Thermostatic element 821, 45 °C	1
187032	Thermostatic element 821, 55 °C	1
187033	Thermostatic element 821, 61 °C	1
187034	Thermostatic element 821, 66 °C	1
187035	Thermostatic element 821, 72 °C	1
187036	Thermostatic element 821, 80 °C	1
187107	Insulation, DN 15-20	2
187108	Insulation, DN 25-32	2

LK 823 ThermoVar®



TECHNICAL DATA

Opening temperature	45 °C, 50 °C, 55 °C, 60 °C, 65 °C or 70 °C
Working temperature	(45 °C - 55 °C) Min. 5 °C/Max. 95 °C (60 °C - 70 °C) Min. 5 °C/Max. 110 °C
Ambient temp.	Min. 5 °C/Max. 60 °C
Max. working pressure	1.0 MPa (10 bar)
Max. differential pressure	100 kPa (1 bar)
Leakage	< 0.5% of Kvs at 100 kPa
Media	Water - Glycol mixture max. 50%
Thread standard	Rp - female thread, G - male thread
Material, valve body	Brass EN 1982 CB753S
Material, internal cover	Brass EN 12165 CW617N
Material, sealing	EPDM

LK 823 ThermoVar® is a 3-way thermic loading valve for solid fuel/storage tank installations. The valve is intended to ensure both an optimal temperature stratification in the storage tank and a high return temperature to the boiler, thus increasing the efficiency of the system. Tarring and condensation are prevented which prolongs boiler life.

The valve regulates on two ports, which means that there is no need for a balancing valve in the circuit between boiler and loading valve. The thermostatic element starts to open port A at an outgoing mixed water temperature in port AB of 45 °C, 50 °C, 55 °C, 60 °C, 65 °C or 70 °C. Port B is closed when the temperature in port A exceeds the nominal opening temperature by 10 °C.

LK 823 can be equipped with an insulation - see under Accessories. For more information, please see the product sheet for insulations.

The valve can be mounted at any angle. LK 823 ThermoVar® is for right- or left-hand mounting.

CAPACITY DIAGRAM

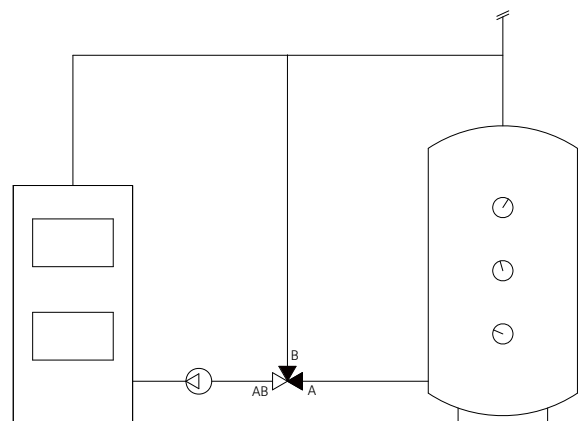
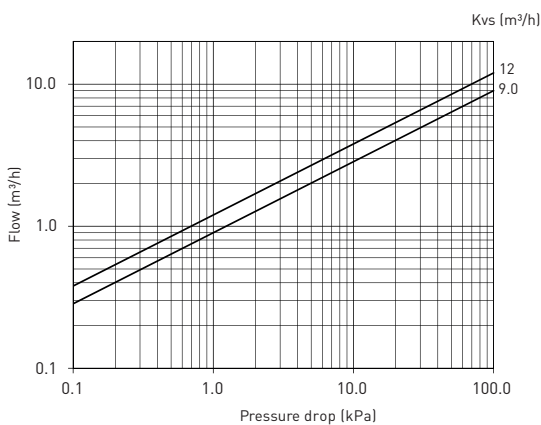

LK 823 - Female thread

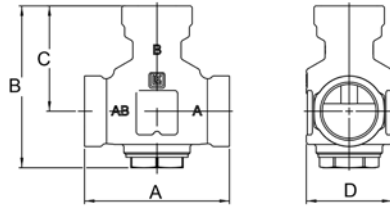

Article no.	Opening temperature	Dimension	Kvs m ³ /h	A mm	B mm	C mm	D mm	Weight kg
181284	45 °C	F 1"	9	92	114	72,5	Ø 55	1.0
181288	45 °C	F 1¼"	12	105	117	76	Ø 62	1.2
181285	50 °C	F 1"	9	92	114	72,5	Ø 55	1.0
181289	50 °C	F 1¼"	12	105	117	76	Ø 62	1.2
181286	55 °C	F 1"	9	92	114	72,5	Ø 55	1.0
181290	55 °C	F 1¼"	12	105	117	76	Ø 62	1.2
181287	60 °C	F 1"	9	92	114	72,5	Ø 55	1.0
181291	60 °C	F 1¼"	12	105	117	76	Ø 62	1.2
181536	65 °C	F 1"	9	92	114	72,5	Ø 55	1.0
181537	65 °C	F 1¼"	12	105	117	76	Ø 62	1.2
181539	70 °C	F 1"	9	92	114	72,5	Ø 55	1.0
181540	70 °C	F 1¼"	12	105	117	76	Ø 62	1.2

LK 823 - Male thread

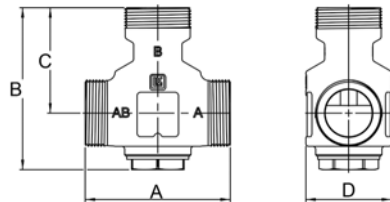

Article no.	Opening temperature	Dimension	Kvs m ³ /h	A mm	B mm	C mm	D mm	Weight kg
182163	45 °C	M 1"	9	84	103,5	62	Ø 55	1.0
181300	45 °C	M 1½"	12	105	117	76	Ø 62	1.2
182130	45 °C	M 1¼"	9	92	110,5	69	Ø 62	1.2
182164	50 °C	M 1"	9	84	103,5	62	Ø 55	1.0
181301	50 °C	M 1½"	12	105	117	76	Ø 62	1.2
182131	50 °C	M 1¼"	9	92	110,5	69	Ø 62	1.2
182165	55 °C	M 1"	9	84	103,5	62	Ø 55	1.0
181302	55 °C	M 1½"	12	105	117	76	Ø 62	1.2
182132	55 °C	M 1¼"	9	92	110,5	69	Ø 62	1.2
182166	60 °C	M 1"	9	84	103,5	62	Ø 55	1.0
181303	60 °C	M 1½"	12	105	117	76	Ø 62	1.2
182133	60 °C	M 1¼"	9	92	110,5	69	Ø 62	1.2
182167	65 °C	M 1"	9	84	103,5	62	Ø 55	1.0
181538	65 °C	M 1½"	12	105	117	76	Ø 62	1.2
182134	65 °C	M 1¼"	9	92	110,5	69	Ø 62	1.2
182168	70 °C	M 1"	9	84	103,5	62	Ø 55	1.0
181541	70 °C	M 1½"	12	105	117	76	Ø 62	1.2
182135	70 °C	M 1¼"	9	92	110,5	69	Ø 62	1.2

SPARE PARTS AND ACCESSORIES

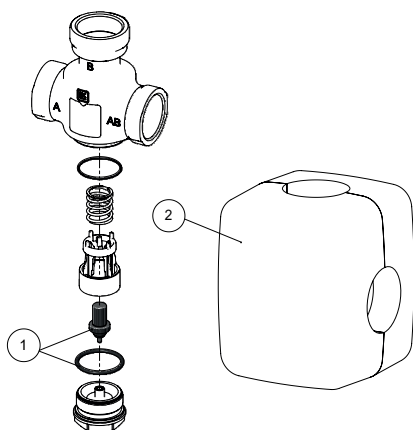

Article no.	Article	Position
187102	Thermostatic element 823, 45 °C	1
187103	Thermostatic element 823, 50 °C	1
187104	Thermostatic element 823, 55 °C	1
187105	Thermostatic element 823, 60°C	1
187138	Thermostatic element 823, 65 °C	1
187139	Thermostatic element 823, 70 °C	1
187109	Insulation, DN 25-32	2

LK 822 ThermoBac



TECHNICAL DATA

Working temperature	Min. 5 °C/Max. 110 °C
Ambient temp.	Min. 5 °C/Max. 60 °C
Max. working pressure	1.0 MPa (10 bar)
Max. differential pressure	50 kPa (0,5 bar)
Media	Water - Glycol mixture max. 50%
Thread standard	Rp - female thread, G - male thread
Material, valve body	Brass EN 12165 CW617N
Material, external cover	Brass EN 12165 CW617N
Material, sealing	EPDM

LK 822 ThermoBac is a 3-way check valve with low opening pressure and high fluid capacity. The valve is especially suitable for heating systems with storage tanks. The check valve prevents self-circulation from storage tank to boiler after the fire has gone out. In case of power failure or pump breakdown LK 822 ThermoBac automatically opens for self-circulation.

LK 822 can be equipped with an insulation - see under Accessories. For more information please see the product sheet for insulations.

The valve should be mounted so that the flap in the check valve closes by its own weight.

CAPACITY DIAGRAM

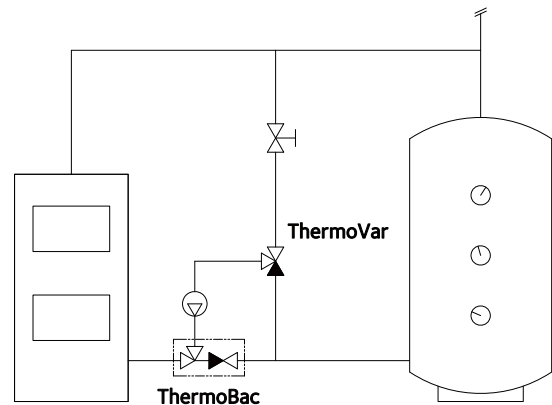
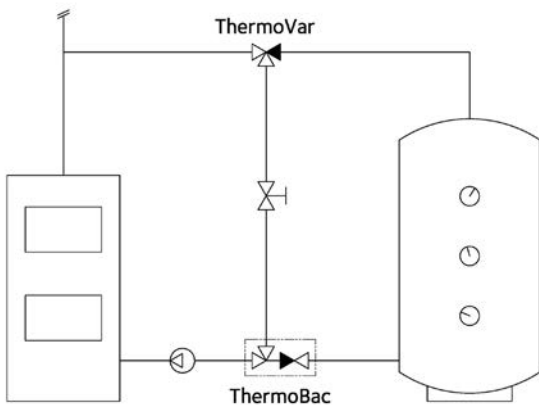
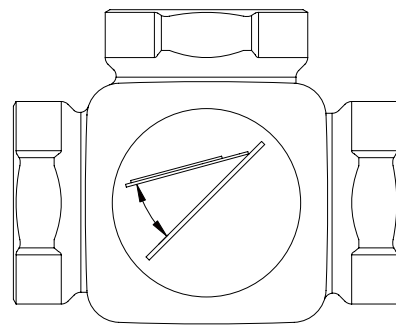
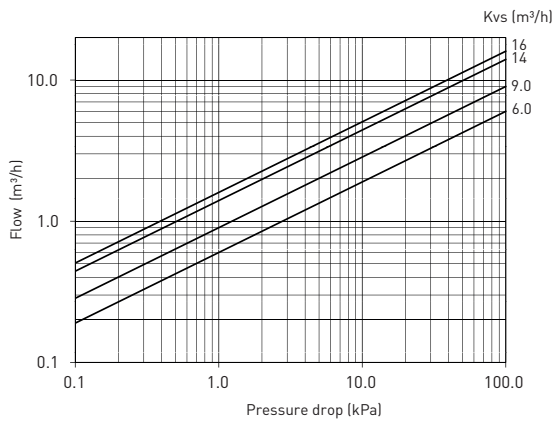

LK 822 - Female thread

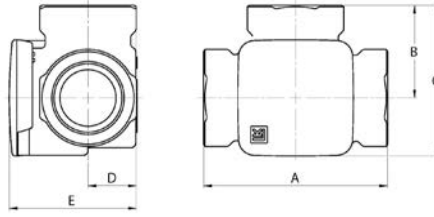

Article no.	Dimension	Kvs m ³ /h	A mm	B mm	C mm	D mm	E mm	Weight kg
181107	F 1/2"	6.0	80	40	66	21	35	0.5
181108	F 3/4"	9.0	80	40	66	21	35	0.5
181109	F 1"	14	82	41	67	21	35	0.7
181110	F 1 1/4"	16	84	42	68	24	39	0.7

LK 822 - Male thread

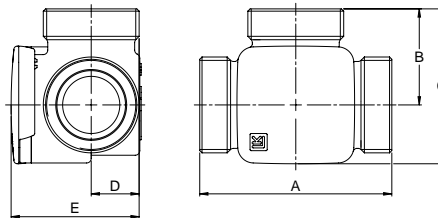

Article no.	Dimension	Kvs m ³ /h	A mm	B mm	C mm	D mm	E mm	Weight kg
181111	M 3/4"	6.0	80	40	66	21	35	0.5
181112	M 1"	9.0	80	40	66	21	35	0.5
181113	M 1 1/4"	14	84	42	68	21	35	0.7
181114	M 1 1/2"	16	84	42	68	24	39	0.8

LK 822 - Compression fitting

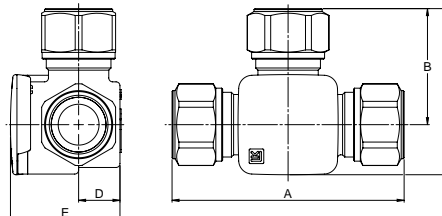

Article no.	Dimension	Kvs m ³ /h	A mm	B mm	C mm	D mm	E mm	Weight kg
181115	15 mm	6.0	114	57	83	21	35	0.6
181116	22 mm	6.0	114	57	83	21	35	0.5
181117	28 mm	9.0	120	60	86	21	35	0.7

SPARE PARTS AND ACCESSORIES

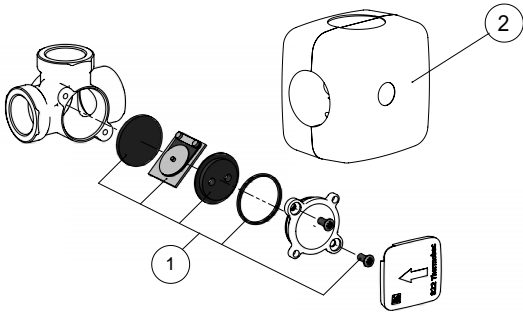

Article no.	Article	Position
187072	Repair kit 822, DN 15-32	1
187107	Insulation, DN 15-20	2
187108	Insulation, DN 25-32	2

LK Insulation



TECHNICAL DATA

Working temperature	Min. -20 °C/Max. 130 °C
Ambient temp.	Min. -20 °C/Max. 130 °C
Material, insulation	Expanded Polypropylene EPP
Thermal conductivity	0.035 W/mK
Density	35 g/l

The LK Armatur insulation has been developed for ThermoVar® thermic valves, ThermoBac check valves, ThermoMix® mixing valves and MultiZone zone valves to provide effective protection against energy losses.

The insulation is available in three versions. One is designed for LK 823 ThermoVar®, one for valve types LK 820, 821 ThermoVar®, 822 ThermoBac, 840 and 841 ThermoMix® and one for 525 MultiZone 3V, Solar and Polar. In the standard design it fits LK 820, 821 ThermoVar® and LK 822 ThermoBac.

Cut-outs for spindle and valve port are easily done to adapt the insulation to LK 840 and 841 ThermoMix®, with or without an installed electronic controller.

The insulation's closing function allows a quick and easy mounting.

LK Insulation - LK 525 3V, Solar, Polar

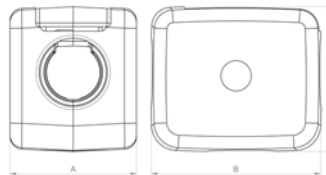

Article no.	Type	Dimension	A mm	B mm	C mm	D mm	Weight kg
187202	525 3V/R, Solar, Polar	G 1", G 1¼", G ¾", 22 mm, 28 mm	284	194	117	62	0.1

LK Insulation - LK 820, 821, 822, 840, 841

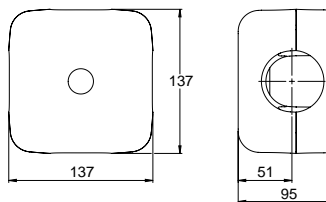

Article no.	Type	Dimension	DN	Weight kg
187107	820, 821, 822, 840, 841	M ¾", M 1", F ½", F ¾"	DN 15-20	0.1
187108	820, 821, 822, 840, 841	M 1¼", M 1½", F 1", F 1¼"	DN 25-32	0.1

LK Insulation - LK 823

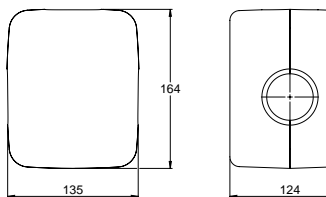

Article no.	Type	Dimension	DN	Weight kg
187109	823	M 1½", F 1", F 1¼"	25-32	0.1

Mixing Valves



LK 830 and LK 831 ThermoMix® B

4-way bivalent mixing valves made of brass.



LK 840 and LK 840C ThermoMix®

3-way mixing valves made of brass.



LK 841 ThermoMix®

4-way mixing valves made of brass.

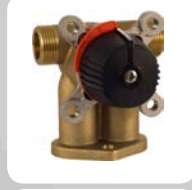

LK 842 ThermoMix® P

4-way mixing valves made of brass.



LK 843 ThermoMix® P

3-way mixing valves made of cast iron.



LK 845 and LK 846 ThermoMix®

3- and 4-way mixing valves made of cast iron.



LK 850 and LK 851 ThermoMix® H

3- and 4-way mixing valves made of brass.

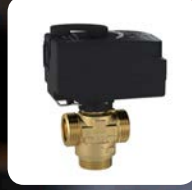

LK 525 MultiZone 3R

3-way valve that can be used as a mixing valve or as a diverting valve in heating systems.



LK Insulation

Insulation for MultiZone, ThermoMix®, ThermoVar®, ThermoBac and MultiZone.



LK 830 ThermoMix® B



TECHNICAL DATA

Working temperature	Min. 5 °C/Max. 110 °C (120 °C briefly)
Ambient temp.	Min. 5 °C/Max. 60 °C
Max. working pressure	1.0 MPa (10 bar)
Max. differential pressure	50 kPa (0.5 bar)
Leakage	< 0.5% of Kvs at 50 kPa
Angle of rotation	90°
Torque	< 1 Nm
Media	Water - Glycol/Ethanol mixture max. 50%
Thread standard	Rp - female thread, G - male thread
Material, valve body	Brass EN 12165 CW617N
Material, external cover	Brass EN 12165 CW617N
Material, slide/spindle	Brass EN 12164 CW614N
Material, sealing	EPDM
Spindle sealing	Two O-rings

LK 830 ThermoMix® B 4-way bivalent mixing valves are designed for heating systems, where energy is taken from two heating units connected in series or parallel or for storage tank systems where energy is extracted from two levels.

LK 830 ThermoMix® B should be equipped with an automatic control unit to ensure that the most favourable heat source is prioritised at all times.

The valve can be mounted at any angle. Valve ports are marked 1-4. In the standard version the valve can be mounted according to 1=Supply, 2=Secondary heat, 3=Primary heat and 4=Return.

LK 830 ThermoMix® B can be adapted for right- or left-hand installation.

VALVE CHARACTERISTICS

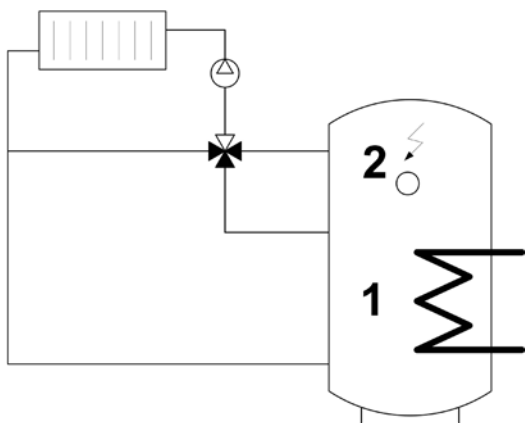
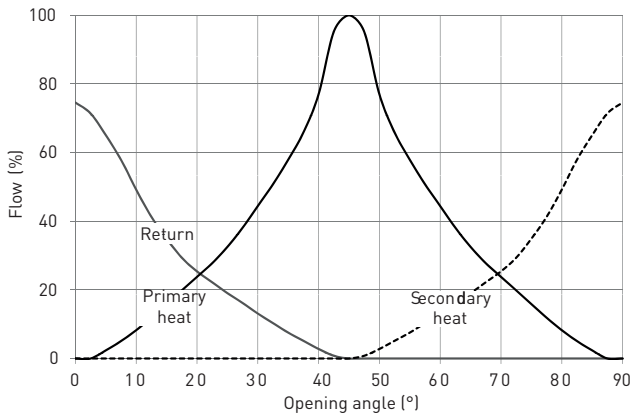

CAPACITY DIAGRAM

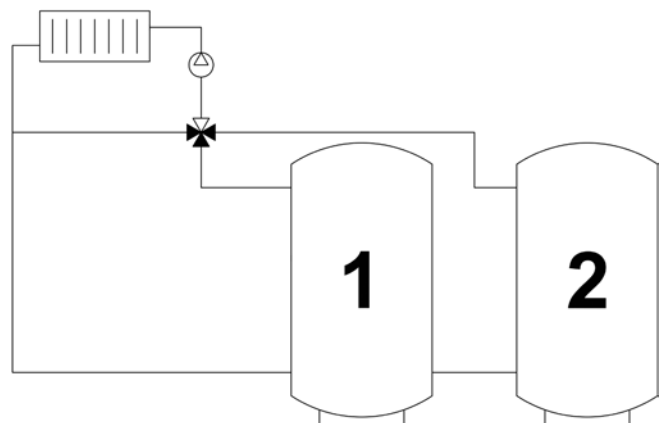
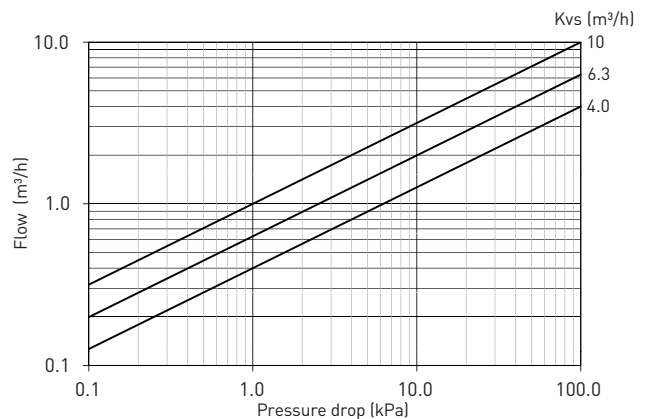

LK 830 - Female thread

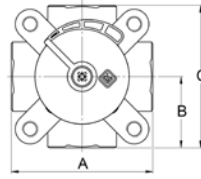
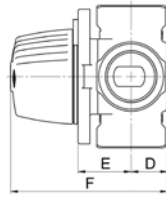

Article no.	Dimension	Kvs m ³ /h	A mm	B mm	C mm	D mm	E mm	F mm	Weight kg
180587	F ¾"	6.3	72	36	72	19	27	80	0.7
180589	F 1"	10	82	41	82	21	30	85	0.9

LK 830 - Male thread

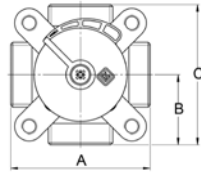
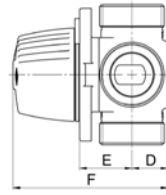

Article no.	Dimension	Kvs m ³ /h	A mm	B mm	C mm	D mm	E mm	F mm	Weight kg
180002	M ¾"	4.0	72	36	72	20	26	80	0.6
180004	M ¾"	6.3	72	36	72	20	26	80	0.6
180588	M 1"	6.3	72	36	72	19	27	80	0.7
180590	M 1¼"	10	82	41	82	21	30	85	1.0

LK 830 - Compression fitting

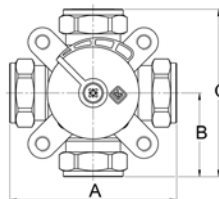
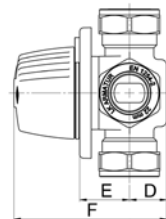

Article no.	Dimension	Kvs m ³ /h	A mm	B mm	C mm	D mm	E mm	F mm	Weight kg
180592	15 mm	4.0	87	43,5	87	20	26	80	0.7
180001	22 mm	4.0	87	43,5	87	20	26	80	0.7
180003	22 mm	6.3	87	43,5	87	20	26	80	0.7
180595	28 mm	6.3	112	56	112	19	27	80	1.1

SPARE PARTS AND ACCESSORIES

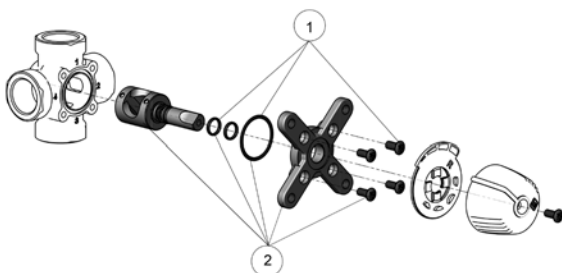

Article no.	Article	Position
187059	Sealing kit 830/831, DN 15-20	1
187060	Sealing kit 830, DN 25	1
187061	Repair kit 830, DN 15-20, Kvs 4.0	2
187062	Repair kit 830, DN 15-20, Kvs 6.3	2
187063	Repair kit 830, DN 25, Kvs 6.3	2
187064	Repair kit 830, DN 25, Kvs 10	2

LK 831 ThermoMix® B



TECHNICAL DATA

Working temperature	Min. 5 °C/Max. 110 °C (120 °C briefly)
Ambient temp.	Min. 5 °C/Max. 60 °C
Max. working pressure	1.0 MPa (10 bar)
Max. differential pressure	50 kPa (0.5 bar)
Leakage	< 1% of Kvs at 50 kPa
Angle of rotation	90°
Torque	< 1 Nm
Media	Water - Glycol/Ethanol mixture max. 50%
Material, valve body	Brass EN 12165 CW617N
Material, external cover	Brass EN 12165 CW617N
Material, slide/spindle	Brass EN 12164 CW614N
Material, sealing	EPDM
Spindle sealing	Two O-rings

LK 831 ThermoMix® B 4-way bivalent mixing valves are designed for heating systems, where energy is taken from two heating units connected in series or parallel or for storage tank systems where energy is extracted from two levels.

LK 831 ThermoMix® B should be equipped with an automatic control unit to ensure that the most favourable heat source is prioritised at all times.

The valve can be mounted at any angle. Valve ports are marked 1-4. The valve is to be mounted according to 1=Supply, 2=Return, 3=Secondary heat and 4=Primary heat.

VALVE CHARACTERISTICS

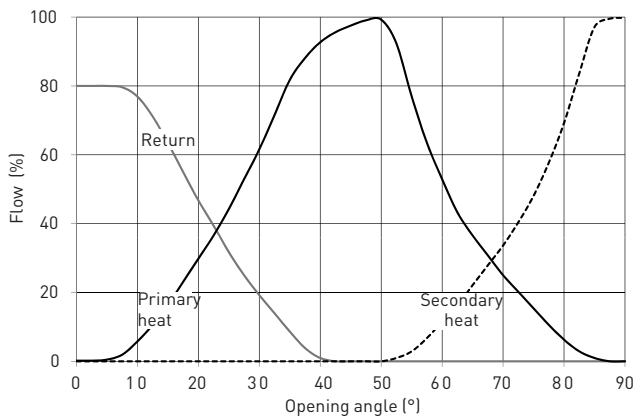

CAPACITY DIAGRAM

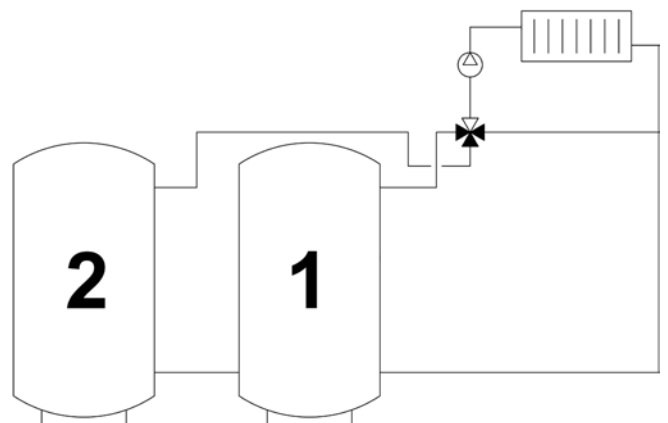
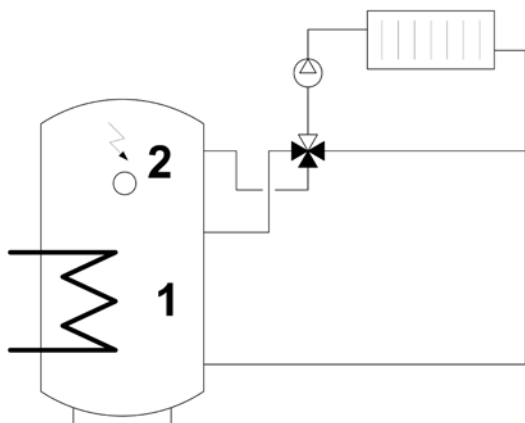
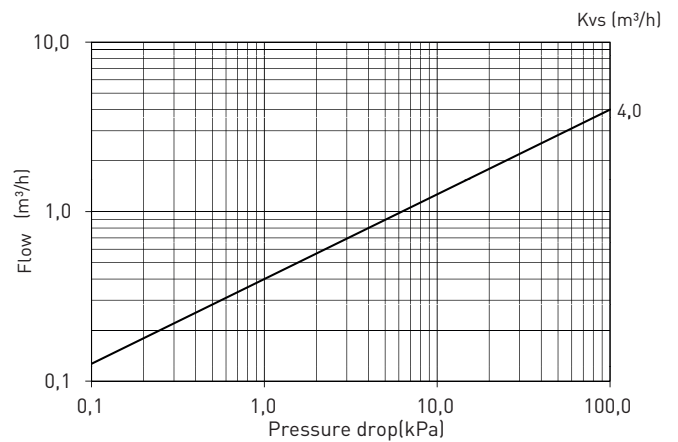

LK 831 - Compression fitting

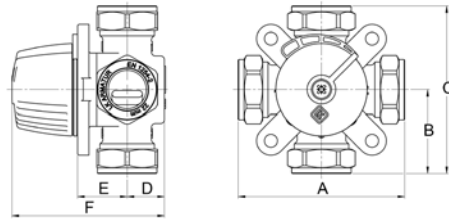

Article no.	Dimension	Kvs m ³ /h	A mm	B mm	C mm	D mm	E mm	F mm	Weight kg
180591	22 mm	4.0	87	43,5	87	20	26	80	0.7

SPARE PARTS AND ACCESSORIES

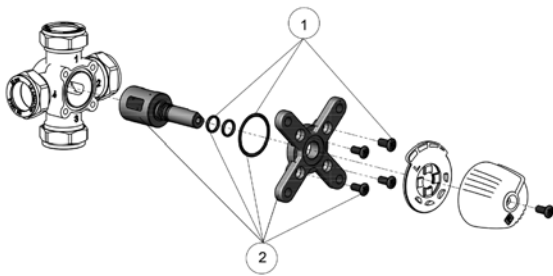

Article no.	Article	Position
187059	Sealing kit 830/831, DN 15-20	1
187065	Repair kit 831, DN 20, Kvs 4.0	2

LK 840 ThermoMix® 2.0



TECHNICAL DATA

Working temperature	Min. 5 °C/Max. 110 °C (120 °C briefly)
Ambient temp.	Min. 5 °C/Max. 60 °C
Max. working pressure	1.0 MPa (10 bar)
Max. differential pressure	100 kPa (1 bar)
Leakage	< 0,2% of Kvs at 100 kPa
Angle of rotation	90°/360°
Torque	< 1 Nm (DN15-32)* < 2,1-2,3 Nm (DN40-50)*
Media 1	Water - Glycol mixture max. 50%
Media 2	Water - Ethanol mixture max. 30%
Thread standard	Rp - female thread, G - male thread
Material, valve body	Brass EN 12165 CW617N
Material, internal cover	PPS Composite
Material, external cover	DN15-32 Aluminium, DN40-50 Composite
Material, slide/spindle	Brass EN 12165 CW617N
Material, sealing	EPDM
Spindle sealing	Two O-rings

LK 840 ThermoMix® 2.0 is a 3-way mixing valve which can be used as a mixing or diverting valve in heating systems.

The valve is suitable for motorization and can be fitted with insulation. For more information, see the insulation data sheet.

A compact design and a octagonal key grip gives an easier access and installation in tight spaces. The valve can be installed in any position and LK 840 ThermoMix® 2.0 can easily be adapted for right- or left-hand mounting.

The valve requires no maintenance but the installation should be checked regularly.

* Double torque if the valve is used diverting.

VALVE CHARACTERISTICS

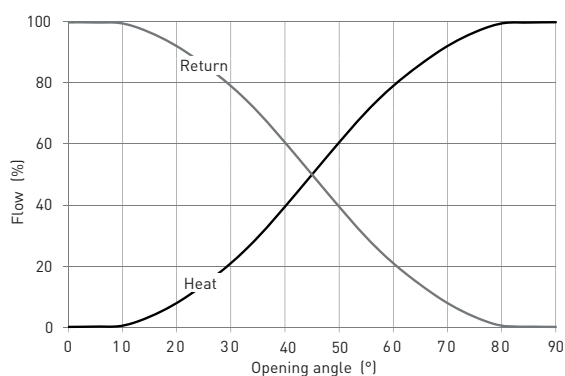

CAPACITY DIAGRAM

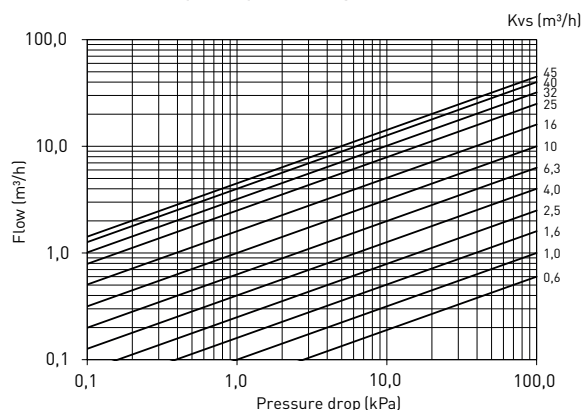

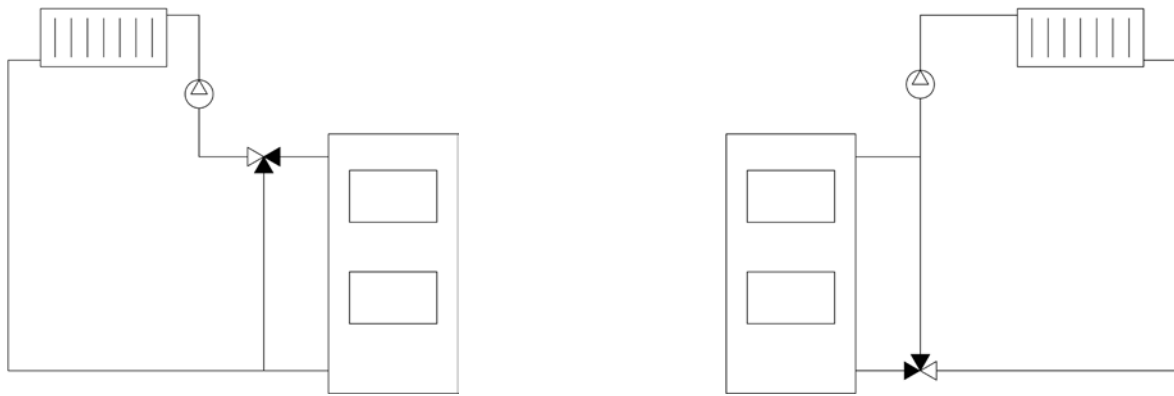

LK 840 2.0 - Female thread

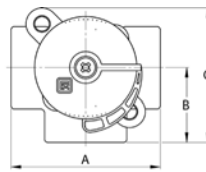
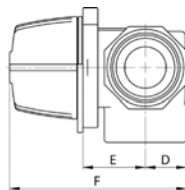

Article no.	Dimension	Kvs m ³ /h	A mm	B mm	C mm	D mm	E mm	F mm	Weight kg
181908	F 1/2"	0.6	70	35	69	18	29	81	0.5
181909	F 1/2"	1.0	70	35	69	18	29	81	0.5
181910	F 1/2"	1.6	70	35	69	18	29	81	0.5
181911	F 1/2"	2.5	70	35	69	18	29	81	0.5
181912	F 3/4"	4.0	70	35	69	18	29	81	0.5
181913	F 3/4"	6.3	70	35	69	18	29	81	0.5
181914	F 1"	6.3	70	35	69	20	29	83	0.5
181915	F 1"	10	70	35	69	20	29	83	0.5
181916	F 1 1/4"	16	84	42	77	24	32	90	0.8

LK 840 2.0 - Female thread

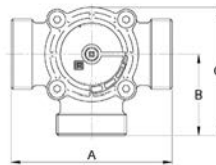
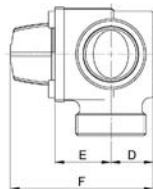

Article no.	Dimension	Kvs m ³ /h	A mm	B mm	C mm	D mm	E mm	F mm	Weight kg
181917	F 1 1/2"	25	106	53	88	33	43	110	1.4
181918	F 2"	40	106	53	88	33	43	110	1.6

LK 840 2.0 - Male thread

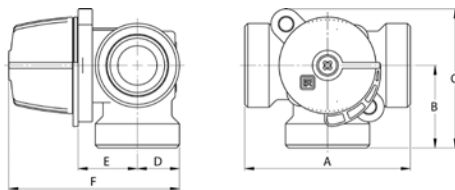

Article no.	Dimension	Kvs m ³ /h	A mm	B mm	C mm	D mm	E mm	F mm	Weight kg
181919	M ¾"	2.5	80	40	74	18	29	81	0.6
181920	M 1"	4.0	80	40	74	18	29	81	0.6
181921	M 1"	6.3	80	40	74	18	29	81	0.6
181922	M 1½"	10	82	41	75	20	29	83	0.6
181923	M 1½"	16	84	42	77	24	32	90	0.8

The connecting dimensions for 840 ThermoMix 2.0 male thread equals 840 ThermoMix 1.0.

LK 840 2.0 - Male thread



Article no.	Dimension	Kvs m ³ /h	A mm	B mm	C mm	D mm	E mm	F mm	Weight kg
181924	M 2"	25	124	62	97	33	43	110	1.4
181925	M 2"	32	124	62	97	33	43	110	1.4
181926	M 2"	45	124	62	97	33	43	110	1.4

The connecting dimensions for 840 ThermoMix 2.0 male thread equals 840 ThermoMix 1.0.

LK 840 2.0 - Compression Fitting

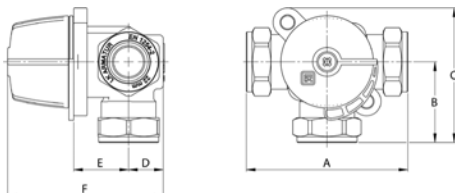

Article no.	Dimension	Kvs m ³ /h	A mm	B mm	C mm	D mm	E mm	F mm	Weight kg
181927	15 mm	2.5	114	57	91	18	29	81	0.7
181928	18 mm	2.5	114	57	91	18	29	81	0.7
181929	22 mm	2.5	114	57	91	18	29	81	0.7
181930	22 mm	6.3	84	42	76	18	29	81	0.7
181931	28 mm	4.0	120	60	94	18	29	81	0.7
181932	28 mm	6.3	120	60	94	18	29	81	0.7

SPARE PARTS AND ACCESSORIES

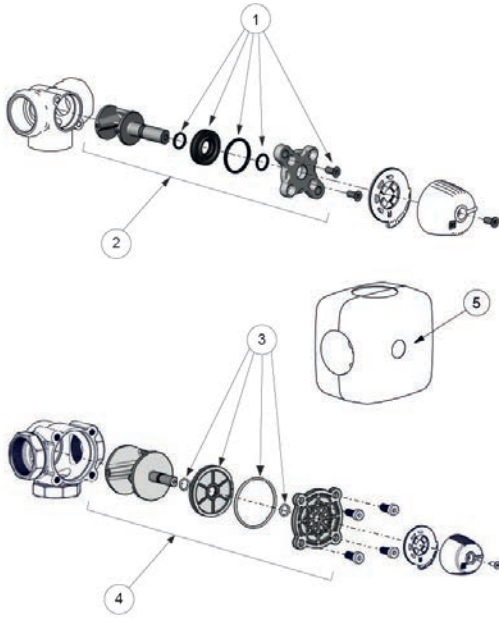

Article no.	Article	Position
187188	Sealing kit LK 840/841 DN 25	1
187187	Sealing kit LK 840/841 DN 15-20	1
187197	Sealing kit 840/841 2.0, DN 32	1
187191	Repair kit 840 DN 25	2
187190	Repair kit LK 840 DN 15-20	2
187192	Repair kit LK 840 DN 32	2
187189	Sealing kit 840/841 2.0, DN 40-50	3
187193	Repair kit LK 840 DN 40-50	4
187107	Insulation, DN 15-20	5
187108	Insulation, DN 25-32	5

LK 840 ThermoMix® C



TECHNICAL DATA

Working temperature	Min. 5 °C/Max. 110 °C (120 °C briefly)
Ambient temp.	Min. 5 °C/Max. 60 °C (Mixing valve) Min. 0 °C/Max. 50 °C (Actuator)
Max. working pressure	1.0 Mpa (10 bar)
Max. differential pressure	50 kPa (0.5 bar)
Leakage	< 1% of Kvs at 50 kPa
Angle of rotation	90°/360° (Mixing valve) 90° (Actuator - electrically limited)
Torque	< 1 Nm (Mixing valve) 5 Nm (Actuator)
Media	Water - Glycol/Ethanol mixture max. 50%
Thread standard	Rp - female thread, G - male thread
Actuator	230 VAC 50 Hz 24 VAC 50 Hz
Operation time	110 s
Direction of operation	Selectable
Position indication	Reversible scale
Manual override	Disengagement of gears
Electrical connection	Cable 1 m
Signal connector	3-point SPDT 0 - 10 VDC/4-20 mA
Protection type	IP 44
Protection class	II
Material, valve body	Brass EN 12165 CW617N
Material, slide/spindle	Brass EN 12165 CW617N
Material, sealing	EPDM
Spindle sealing	Two O-rings

LK 840 ThermoMix C is a motorized 3-way valve that can be used as a mixing valve or as a diverting valve in heating systems.

Actuator LK 940 ThermoMix C shall be used on LK 840 ThermoMix C. Assembly/disassembly of actuator on LK 840 ThermoMix C is simple and secure, using the clip-system.

Depending on model the actuator can be operated by a controller with a 3-point SPDT output or a proportional 0-10 V / 4-20 mA output. The angle of rotation is electrically limited to 90°.

When needed, the actuator can be put into manual mode by pressing the button on the housing cover. The actuator can now be put in any position by turning the handle on the front. The position is indicated on the reversible scale.

WIRING DIAGRAM

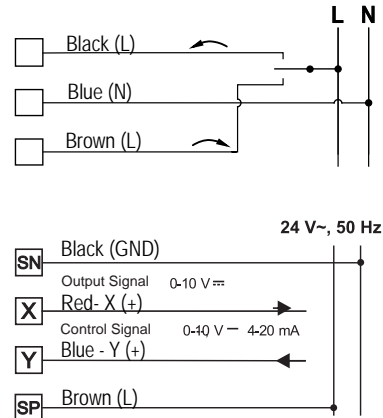

VALVE CHARACTERISTICS

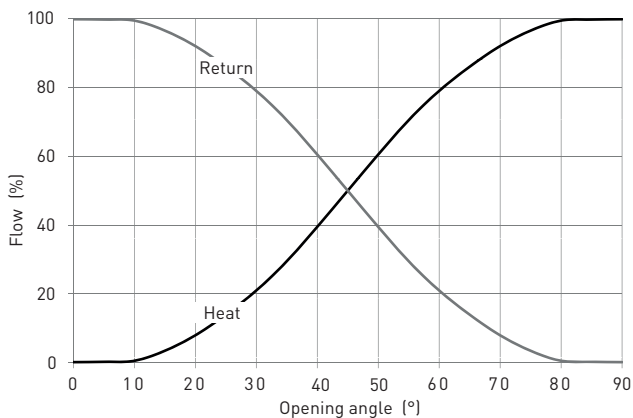

CAPACITY DIAGRAM

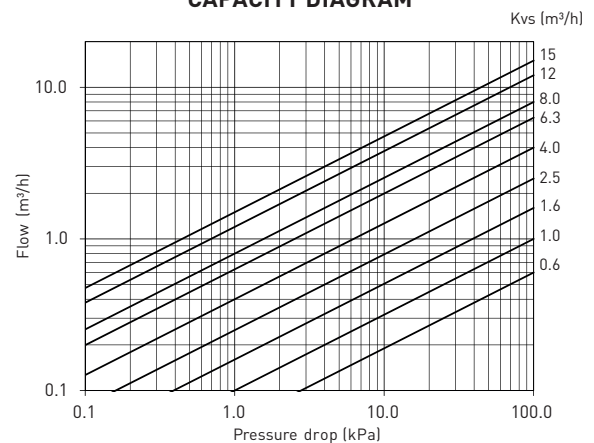

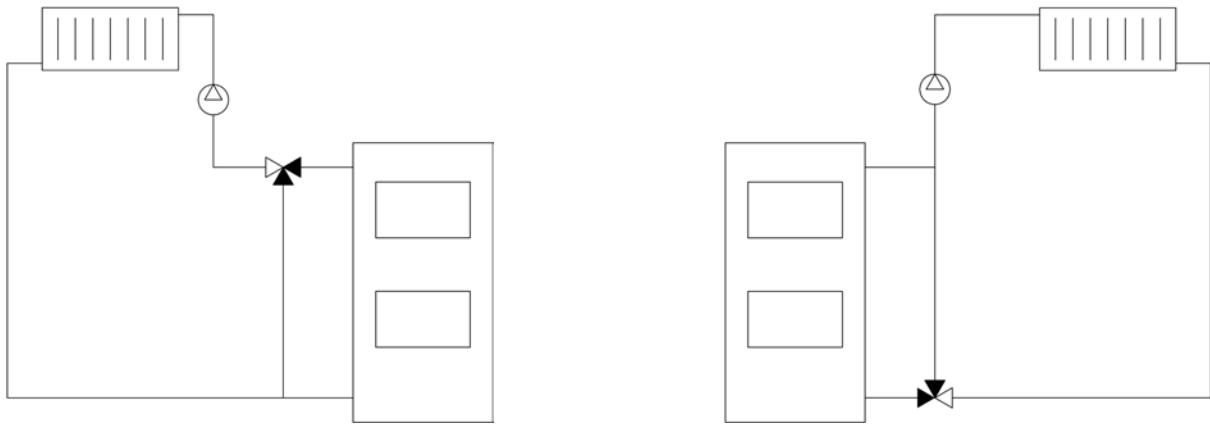

LK 840 C - Female Thread

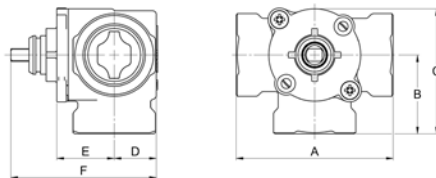

Article no.	Dimension	Kvs m ³ /h	A mm	B mm	C mm	D mm	E mm	F mm	Weight kg
181855	F 1/2"	0.6	80	40	64	20	27	71	0.7
181856	F 1/2"	1.0	80	40	64	20	27	71	0.7
181859	F 3/4"	4.0	80	40	64	20	27	71	0.7
181896	F 1"	6.3	82	41	65	22	30	76	0.8

LK 840 C - Male Thread

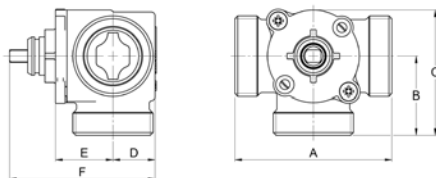

Article no.	Dimension	Kvs m ³ /h	A mm	B mm	C mm	D mm	E mm	F mm	Weight kg
181866	M 3/4"	2.5	80	40	64	20	27	71	0.7
181868	M 1"	6.3	80	40	64	20	27	71	0.7
181870	M 1 1/4"	12	82	41	65	22	30	76	0.8

LK 840 C - Compression fitting

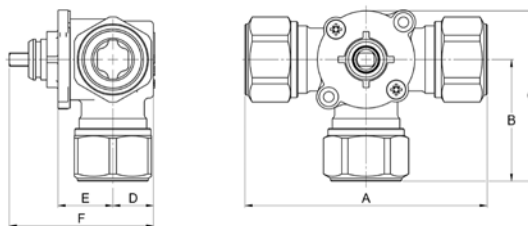

Article no.	Dimension	Kvs m ³ /h	A mm	B mm	C mm	D mm	E mm	F mm	Weight kg
181873	15 mm	2.5	114	57	81	20	27	71	0.8
181874	18 mm	2.5	114	57	81	20	27	71	0.8
181875	22 mm	2.5	114	57	81	20	27	71	0.8
181876	22 mm	6.3	87	44	68	20	27	71	6.3

LK 940 C

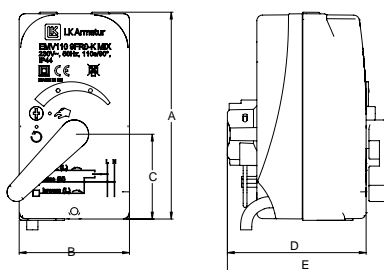

Article no.	Connection	Voltage	Torque	Operation time	A mm	B mm	C mm	D mm	E mm	Weight kg
066127	1 m cable	230 V	5 Nm	110 s	109	58	45	73	85	0.4
066128	1 m cable 0-10 VDC	24 VAC	5 Nm	110 s	109	58	45	73	85	0.4

LK 841 ThermoMix® 2.0



TECHNICAL DATA

Working temperature	Min. 5 °C/Max. 110 °C (120 °C briefly)
Ambient temp.	Min. 5 °C/Max. 60 °C
Max. working pressure	1.0 MPa (10 bar)
Max. differential pressure	100 kPa (1 bar)
Leakage	< 1.5% of Kvs at 50 kPa
Angle of rotation	90°/360°
Torque	< 1 Nm
Media 1	Water - Glycol mixture max. 50%
Media 2	Water - Ethanol mixture max. 30%
Thread standard	Rp - female thread, G - male thread
Material, valve body	Brass EN 12165 CW617N
Material, internal cover	PPS Composite
Material, slide/spindle	Brass EN 12165 CW617N
Material, external cover	Aluminium DN 15-32, Composite DN 40-50
Spindle sealing	Two O-rings
Material, sealing	EPDM

LK 841 ThermoMix® 2.0 is designed for heating systems where a high return temperature is required to prevent corrosion and thus extend the life length of the heat source.

The valve is suitable for motorization and can be fitted with insulation. For more information, see the insulation data sheet.

A compact design and a octagonal key grip gives an easier access and installation in tight spaces. The valve can be installed in any position and LK 841 ThermoMix® 2.0 can easily be adapted for right- or left-hand mounting.

The valve requires no maintenance but the installation should be checked regularly.

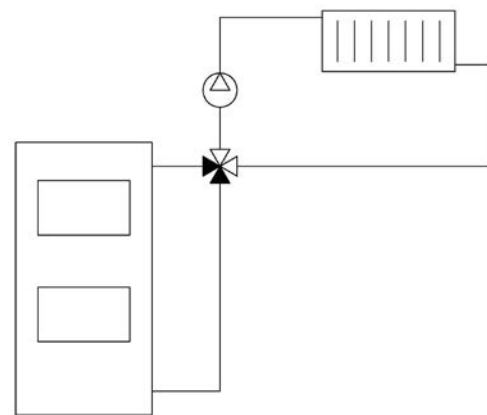

VALVE CHARACTERISTICS

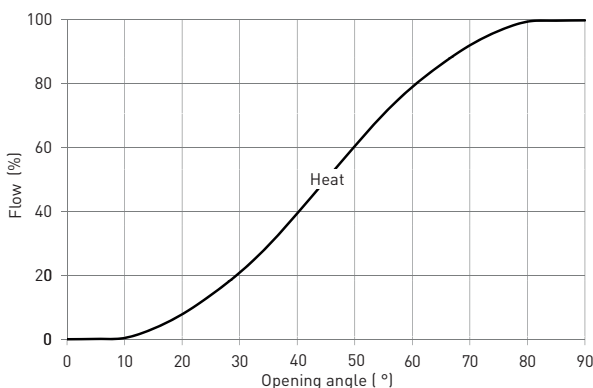

CAPACITY DIAGRAM

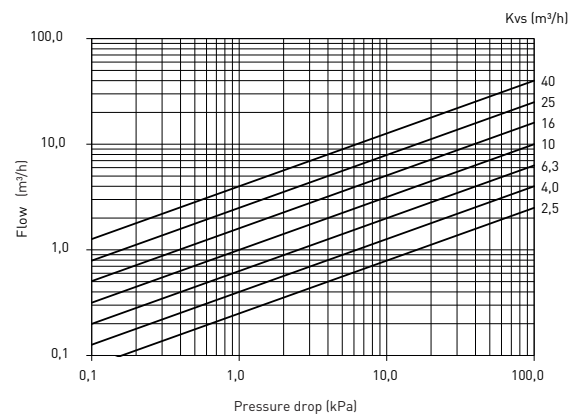

LK 841 2.0 - Female thread

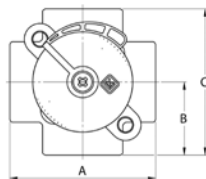
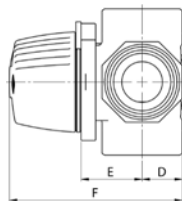

Article no.	Dimension	Kvs m ³ /h	A mm	B mm	C mm	D mm	E mm	F mm	Weight kg
181940	F 1/2"	2.5	70	35	70	18	29	81	0.7
181941	F 3/4"	4.0	70	35	70	18	29	81	0.5
181942	F 3/4"	6.3	70	35	70	18	29	81	0.5
181943	F 1"	10	70	35	70	20	29	83	0.5
181944	F 1 1/4"	16	84	42	84	24	32	90	0.8

LK 841 2.0 - Female thread

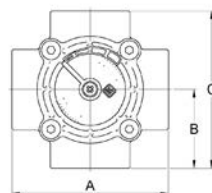
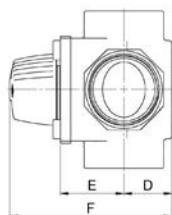

Article no.	Dimension	Kvs m ³ /h	A mm	B mm	C mm	D mm	E mm	F mm	Weight kg
181945	F 1 1/2"	25	106	53	106	33	43	110	1.6
181946	F 2"	40	106	53	106	33	43	110	1.7

LK 841 2.0 - Male thread

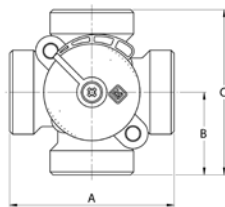
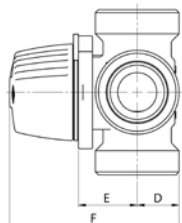

Article no.	Dimension	Kvs m ³ /h	A mm	B mm	C mm	D mm	E mm	F mm	Weight kg
181947	M 3/4"	2.5	80	40	80	18	29	81	0.6
181948	M 1"	4.0	80	40	80	18	29	81	0.5
181949	M 1"	6.3	80	40	80	18	29	81	0.5
181950	M 1 1/4"	10	82	41	82	20	29	83	0.6
181951	M 1 1/2"	16	84	42	84	24	32	90	0.7

The connecting dimensions for 840 ThermoMix 2.0 male thread equals 840 ThermoMix 1.0.

LK 841 2.0 - Compression fitting

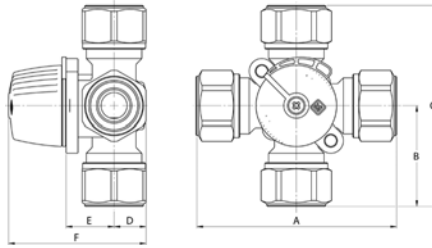

Article no.	Dimension	Kvs m ³ /h	A mm	B mm	C mm	D mm	E mm	F mm	Weight kg
181984	15 mm	2.5	114	57	114	18	29	81	0.9
181985	18 mm	2.5	114	57	114	18	29	81	0.9
181986	22 mm	2.5	114	57	114	18	29	81	0.9
181987	28 mm	4.0	120	60	120	18	29	81	0.8
181988	28 mm	6.3	120	60	120	18	29	81	0.8

SPARE PARTS AND ACCESSORIES

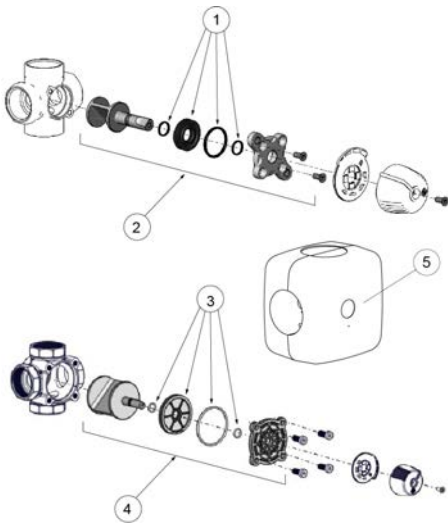

Article no.	Article	Position
187188	Sealing kit LK 840/841 DN 25	1
187187	Sealing kit LK 840/841 DN 15-20	1
187197	Sealing kit 840/841 2.0, DN 32	1
187194	Repair kit 841 2.0, DN 15-20	2
187195	Repair kit 841 2.0, DN 25	2
187198	Repair kit 841 2.0, DN 32	2
187189	Sealing kit 840/841 2.0, DN 40-50	3
187196	Repair kit 841 2.0, DN 40-50	4
187107	Insulation, DN 15-20	5
187108	Insulation, DN 25-32	5

LK 842 ThermoMix® P



TECHNICAL DATA

Working temperature	Min. 5 °C/Max. 110 °C (120 °C briefly)
Ambient temp.	Min. 5 °C/Max. 60 °C
Max. working pressure	1.0 MPa (10 bar)
Max. differential pressure	50 kPa (0,5 bar)
Leakage	< 1.5% of Kvs at 50 kPa
Angle of rotation	90°
Torque	< 1 Nm
Media 1	Water - Glycol/Ethanol mixture max. 50%
Thread standard	G - male thread
Material, valve body	Brass EN 1982 CB753S
Material, internal cover	PPS Composite
Material, external cover	Aluminium
Material, slide/spindle	Brass EN 12165 CW617N
Material, sealing	EPDM
Spindle sealing	Two O-rings

LK 842 ThermoMix® P is a 4-way mixing valve for mounting on heating boilers.

LK 842 ThermoMix® P is suitable for motorization.

The valve can be mounted at any angle. LK 842 ThermoMix® P can easily be adapted for right- or left-hand mounting.

VALVE CHARACTERISTICS

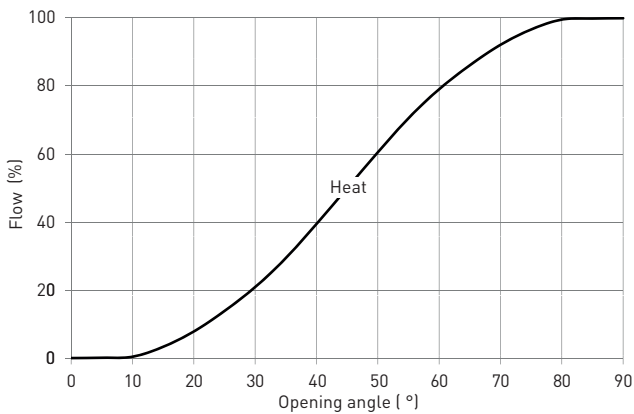

CAPACITY DIAGRAM

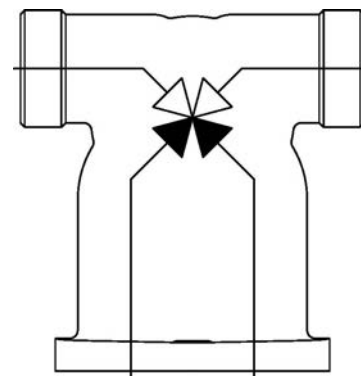
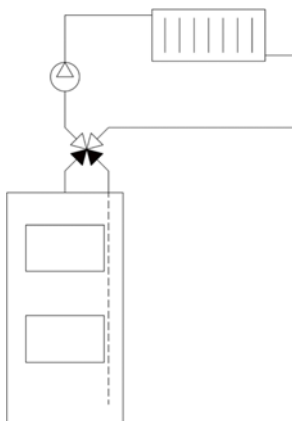
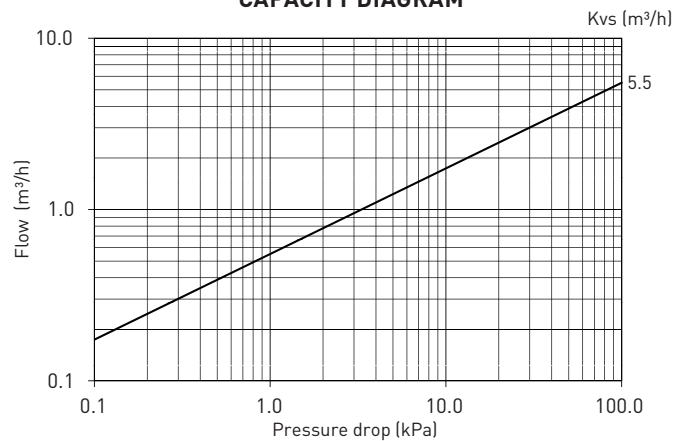

LK 842 - Male thread

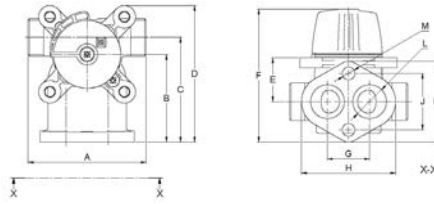

Article no.	Dim.	Kvs m ³ /h	A mm	B mm	C mm	D mm	E mm	F mm	G mm	H mm	J mm	K mm	L mm	M mm	Weight kg
180879	M 3/4"	5.5	84	62	74	97	31	94	30	67	40	57	24	9	0.8

LK 842 - Compression fitting

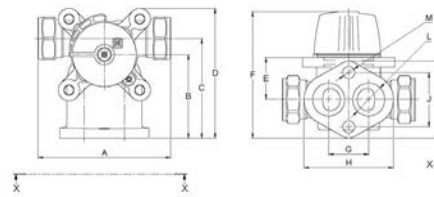

Article no.	Dim.	Kvs m ³ /h	A mm	B mm	C mm	D mm	E mm	F mm	G mm	H mm	J mm	K mm	L mm	M mm	Weight kg
180880	15 mm	5.5	99	62	74	97	31	94	30	67	40	57	24	9	0.8
180881	22 mm	5.5	99	62	74	97	31	94	30	67	40	57	24	9	0.8

SPARE PARTS AND ACCESSORIES

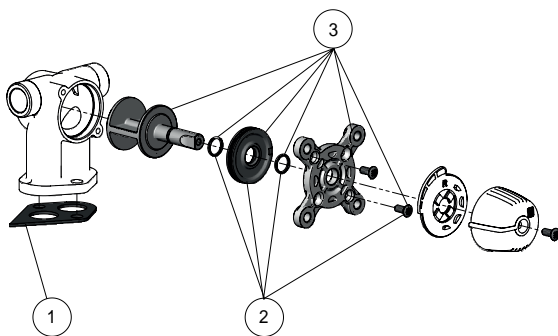

Article no.	Article	Position
013083	Gasket 842	1
187067	Sealing kit 840/841/842, DN 25-32	2
187071	Repair kit 841/842, DN 25-32	3

LK 843 ThermoMix®



TECHNICAL DATA

Working temperature	Min. 2 °C/Max. 110 °C
Max. working pressure	0.6 MPa (6 bar)
Max. differential pressure	50 kPa (0,5 bar)
Leakage	Diverting 0,75% of Kvs, Mixing 1,5% of Kvs
Angle of rotation	90°/360°
Torque	5 Nm (DN20-50) 10 Nm (DN65-100) 15 Nm (DN125-150)
Media	Water - Glycol mixture max. 50%
Media pH	Min. 7/Max. 10
Material, valve body	Cast Iron EN 1561 EN-GJL-250
Material, slide/spindle	CW602 (DN20 - 80) EN 1.4301 (304) (DN100-150)
Connection Flange	PN6
Material, sealing	EPDM

LK 843 ThermoMix® is a 3-way valve which can be used as a mixing valve or as a diverting valve in heating systems.

The valve can be mounted at any angle.

LK 843 ThermoMix® can easily be adapted for right-or left-hand mounting.

VALVE CHARACTERISTICS

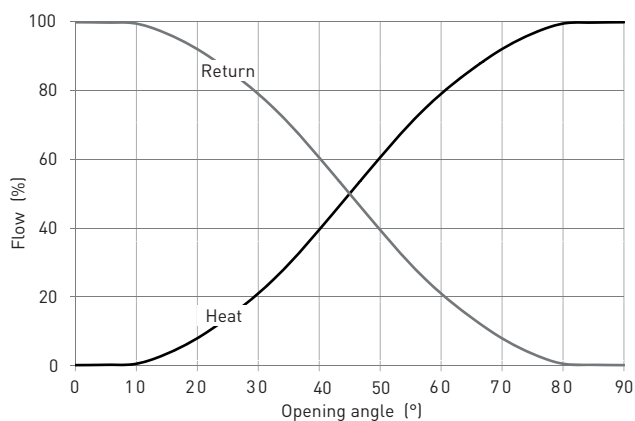

CAPACITY DIAGRAM

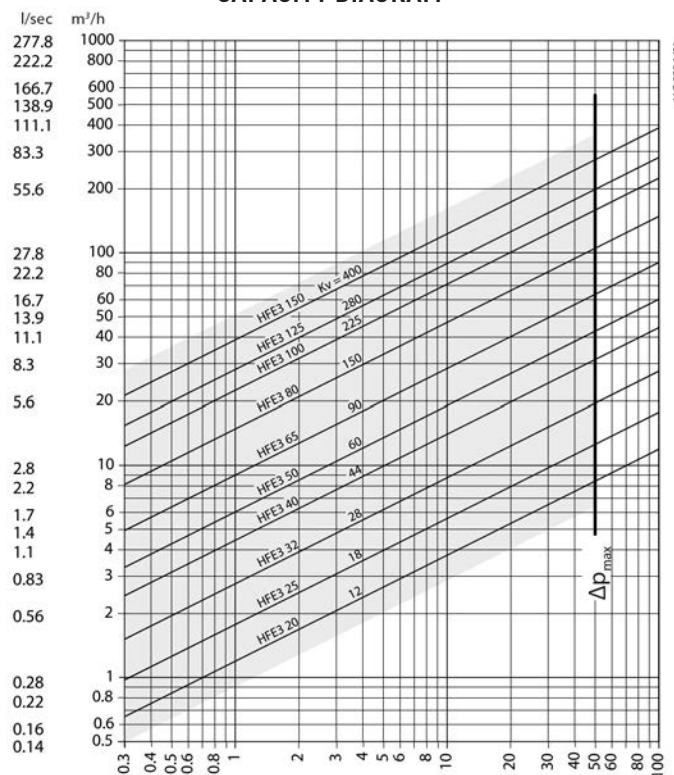

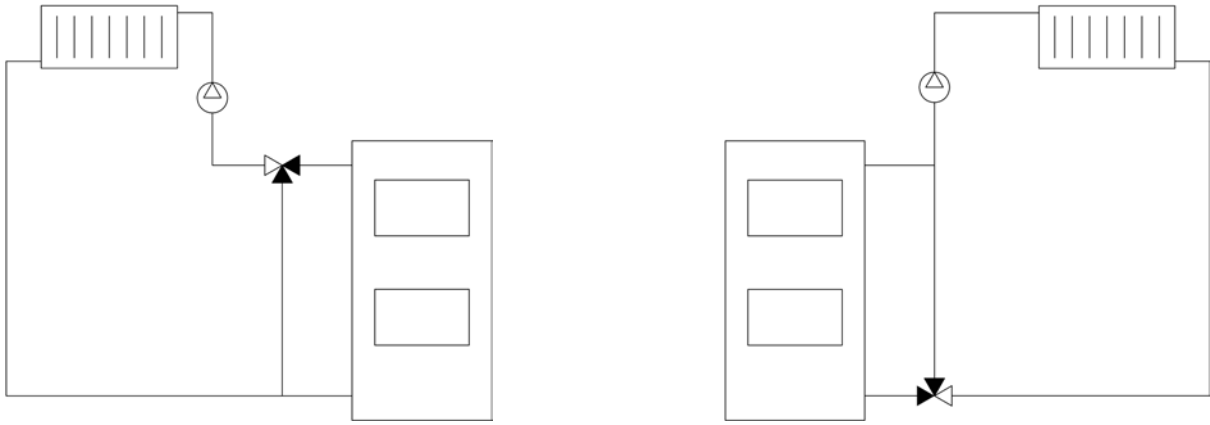

LK 843 - Flange

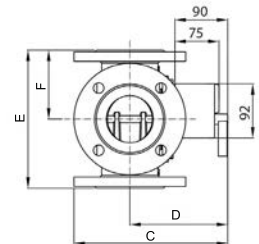
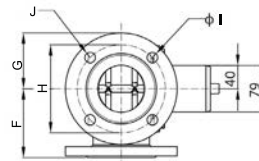
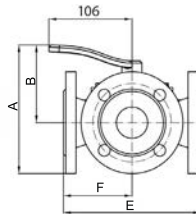

Article no.	DN	Kvs m ³ /h	A mm	B mm	C mm	D mm	E mm	F mm	G mm	H mm	I mm	J mm	Weight kg
182187	20	12	137	92	140	131	140	70	45	65	11,5	4	3.5
182188	25	18	142	92	140	136	150	75	50	75	11,5	4	4.0
182189	32	28	158	98	152	146	160	80	60	90	15	4	6.6
182190	40	44	163	98	157	146	175	88	65	100	15	4	7.2
182191	50	60	177	107	171	155	195	98	70	110	15	4	9.4
182192	65	90	187	107	181	155	200	100	80	130	15	4	11.5
182193	80	150	215	120	208	167	235	118	95	150	18	4	17
182194	100	225	233	128	228	177	265	133	105	170	18	4	22.5
182195	125	230	259	139	253	187	300	150	120	200	18	8	29.5
182196	150	400	277	145	271	192	350	175	133	225	18	8	40.2

LK 845 ThermoMix®



TECHNICAL DATA

Working temperature	Min. 5 °C/Max. 110 °C (120 °C briefly)
Ambient temp.	Min. 5 °C/Max. 60 °C
Max. working pressure	1.0 MPa (10 bar)
Max. differential pressure	50 kPa (0,5 bar)
Leakage	< 2% of Kvs at 50 kPa
Angle of rotation	90°/360°
Torque	< 1 Nm
Media	Water - Glycol/Ethanol mixture max. 50%
Thread standard	Rp - female thread
Material, valve body	Cast Iron EN 1561 EN-GJL-200
Material, external cover	Coated Aluminium
Material, slide/spindle	Brass EN 12165 CW617N
Material, sealing	EPDM
Spindle sealing	Two O-rings

LK 845 ThermoMix® is a 3-way valve that can be used as a mixing valve or as a diverting valve in heating systems.

LK 845 ThermoMix® is suitable for motorization.

The valve can be mounted at any angle. LK 845 ThermoMix® can easily be adapted for right- or left-hand mounting.

VALVE CHARACTERISTICS

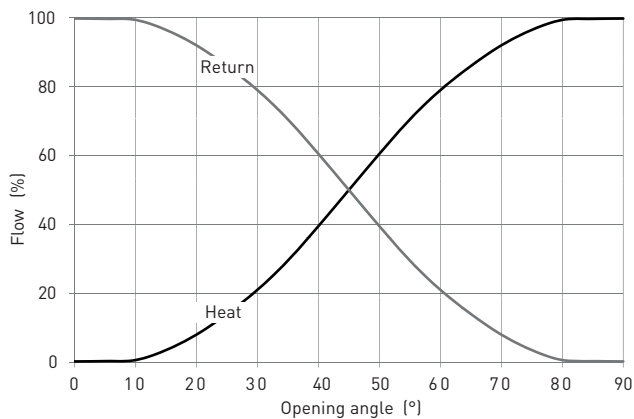

CAPACITY DIAGRAM

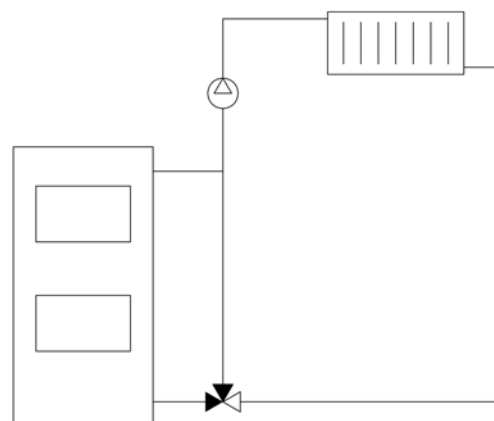
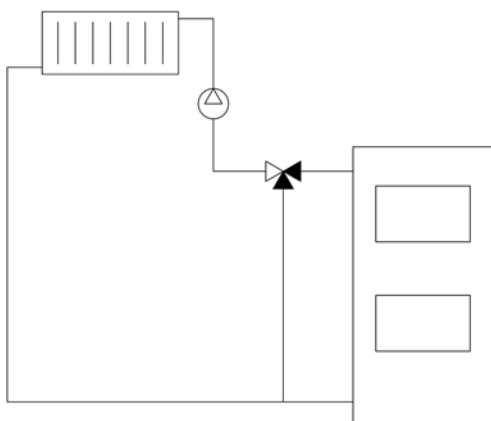
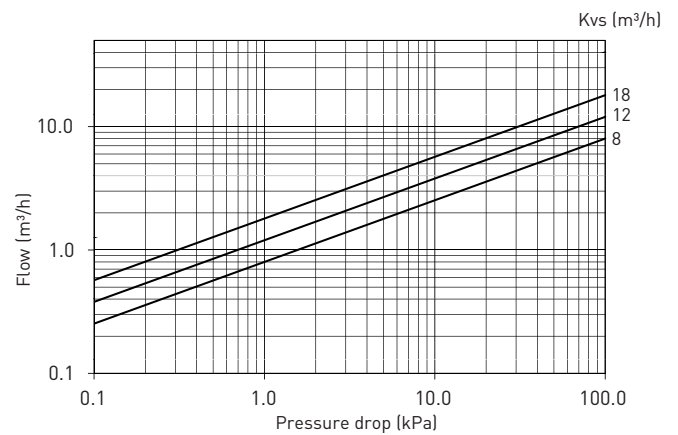

LK 845 - Female thread

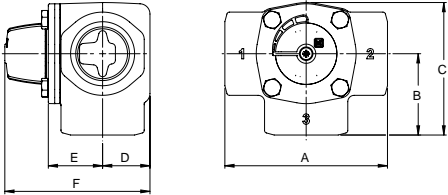

Article no.	Dimension	Kvs m ³ /h	A mm	B mm	C mm	D mm	E mm	F mm	Weight kg
180106	F ¾"	8	112	56	96	36	35	106	2.2
180107	F 1"	12	112	56	96	36	35	106	2.1
180108	F 1¼"	18	127	63,5	103	37	42	113	3.0

The valve is also available with the bevel of the spindle rotated 180° (Design E). For more information please contact our Sales Department.

SPARE PARTS AND ACCESSORIES

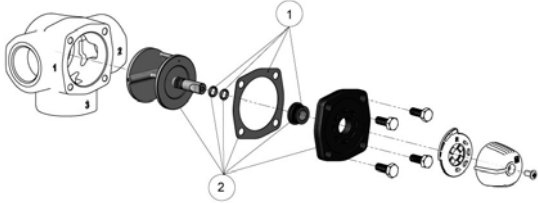

Article no.	Article	Position
187074	Sealing kit 845/846, DN 20-50	1
187075	Repair kit 845, DN 20-50	2

LK 846 ThermoMix®



TECHNICAL DATA

Working temperature	Min. 5 °C/Max. 110 °C (120 °C briefly)
Ambient temp.	Min. 5 °C/Max. 60 °C
Max. working pressure	1.0 MPa (10 bar)
Max. differential pressure	50 kPa (0,5 bar)
Leakage	< 2% of Kvs at 50 kPa
Angle of rotation	90°
Torque	< 1 Nm
Media	Water - Glycol/Ethanol mixture max. 50%
Thread standard	Rp - female thread
Material, valve body	Cast Iron EN 1561 EN-GJL-200
Material, external cover	Coated Aluminium
Material, slide/spindle	Brass EN 12165 CW617N
Material, sealing	EPDM
Spindle sealing	Two O-rings

LK 846 ThermoMix® is a 4-way mixing valve suited for heating systems in which a high return temperature is needed to avoid corrosion, thus prolonging the life-time of the heat source.

LK 846 ThermoMix® is suitable for motorization.

The valve can be mounted at any angle. LK 846 ThermoMix® can easily be adapted for right- or left-hand mounting.

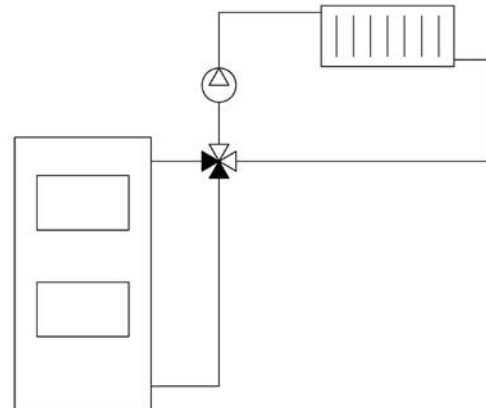

VALVE CHARACTERISTICS

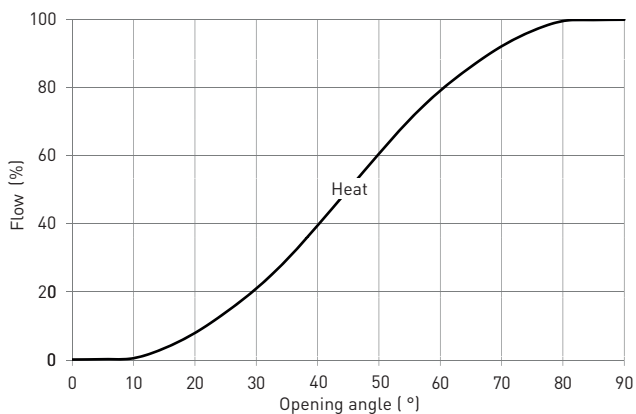

CAPACITY DIAGRAM

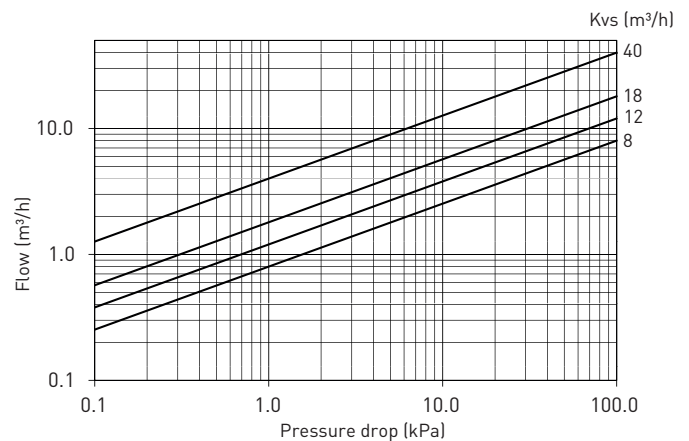

LK 846 - Female thread

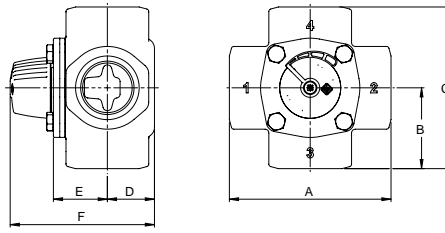

Article no.	Dimension	Kvs m ³ /h	A mm	B mm	C mm	D mm	E mm	F mm	Weight kg
180111	F 3/4"	8	112	56	112	36	35	106	1.8
180112	F 1"	12	112	56	112	36	35	106	1.9
180113	F 1 1/4"	18	127	63,5	127	37	42	113	2.6
180115	F 2"	40	127	63,5	127	44	51	122	4.6

SPARE PARTS AND ACCESSORIES

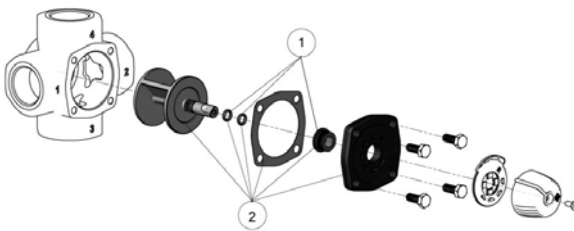

Article no.	Article	Position
187074	Sealing kit 845/846, DN 20-50	1
187076	Repair kit 846, DN 20-50	2

LK 850 ThermoMix® H



TECHNICAL DATA

Working temperature	Min. 5 °C/Max. 110 °C (120 °C briefly)
Ambient temp.	Min. 5 °C/Max. 60 °C
Max. working pressure	1.0 MPa (10 bar)
Max. differential pressure	50 kPa (0.5 bar)
Leakage	< 0.5% of Kvs at 50 kPa
Angle of rotation	90°
Torque	< 3 Nm
Media	Water - Glycol/Ethanol mixture max. 50%
Thread standard	G - male thread
Material, valve body	Brass EN 12165 CW617N
Material, external cover	Brass EN 12165 CW617N
Material, slide/spindle	Brass EN 12165 CW617N
Material, sealing	EPDM
Spindle sealing	Two O-rings

LK 850 ThermoMix® H is a 3-way mixing valve with integrated, adjustable bypass. The bypass can be adjusted up to 50% of the total valve flow.

LK 850 ThermoMix® H is suitable for motorization.

The valve can be mounted at any angle. LK 850 ThermoMix® H can easily be adapted for right- or left-hand mounting.

VALVE CHARACTERISTICS

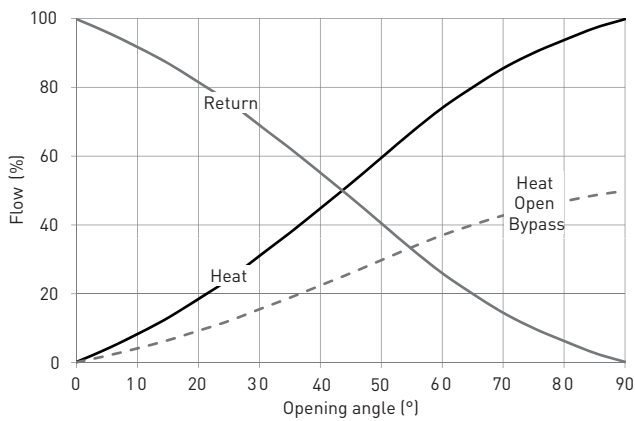

CAPACITY DIAGRAM

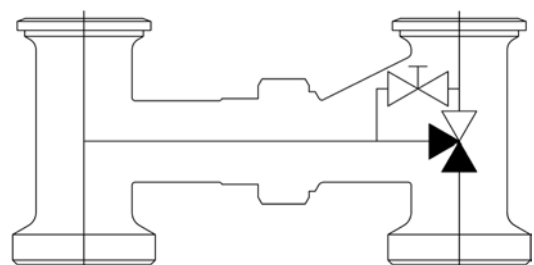
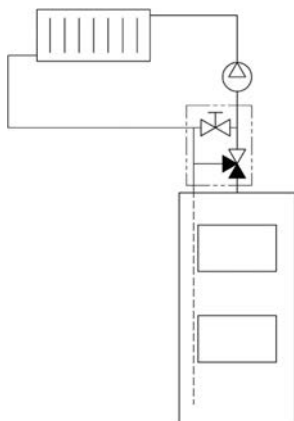
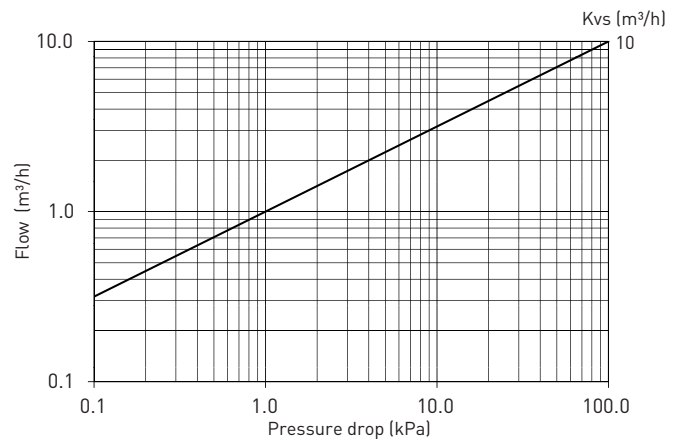

LK 850 - Male thread / Rotating nut

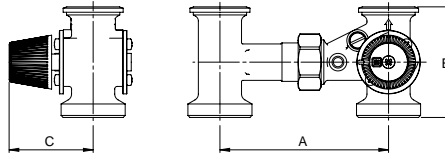

Article no.	Dimension	Kvs m ³ /h	A mm	B mm	C mm	Weight kg
181144	M 1½"	10	125	82	62	1.5

Two 1½" rotating nuts and two gaskets of EPDM are included in the delivery.

SPARE PARTS AND ACCESSORIES

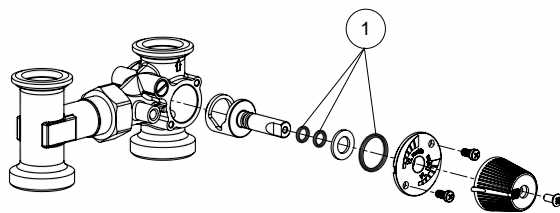

Article no.	Article	Position
187082	Sealing kit 850, DN 40	1

LK 851 ThermoMix® H



TECHNICAL DATA

Working temperature	Min. 5 °C/Max. 110 °C (120 °C briefly)
Ambient temp.	Min. 5 °C/Max. 60 °C
Max. working pressure	1.0 MPa (10 bar)
Max. differential pressure	50 kPa (0.5 bar)
Leakage	< 0.5% of Kvs at 50 kPa
Angle of rotation	90°
Torque	< 3 Nm
Media	Water - Glycol/Ethanol mixture max. 50%
Thread standard	G - male thread
Material, valve body	Brass EN 12165 CW617N
Material, external cover	Brass EN 12165 CW617N
Material, slide/spindle	Brass EN 12165 CW617N
Material, sealing	EPDM
Spindle sealing	Two O-rings

LK 851 ThermoMix® H is a 4-way mixing valve suited for heating systems in which a high return temperature is needed to avoid corrosion, thus prolonging the life-time of the heat source.

LK 851 ThermoMix® H is suitable for motorization.

The valve can be mounted at any angle. LK 851 ThermoMix® H can easily be adapted for right- or left-hand mounting.

VALVE CHARACTERISTICS

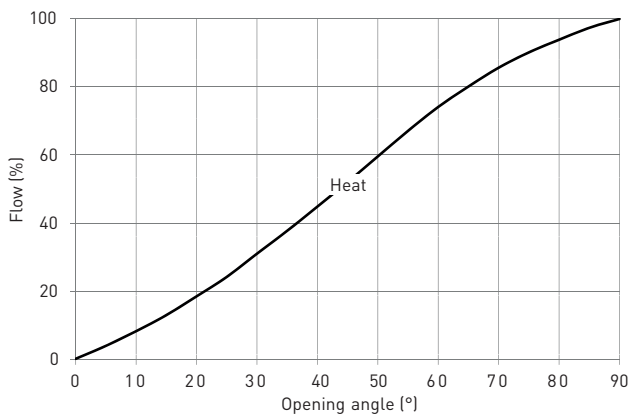

CAPACITY DIAGRAM

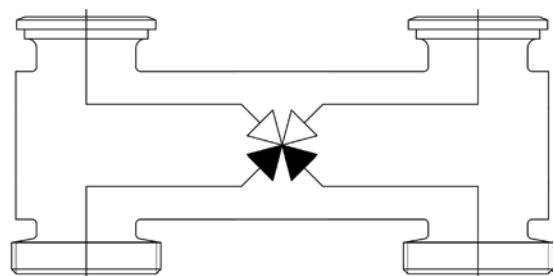
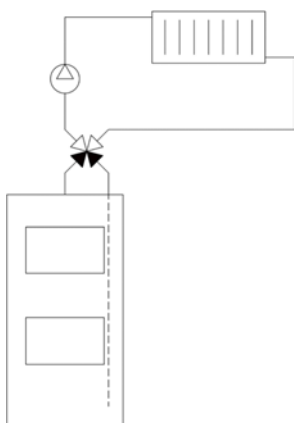
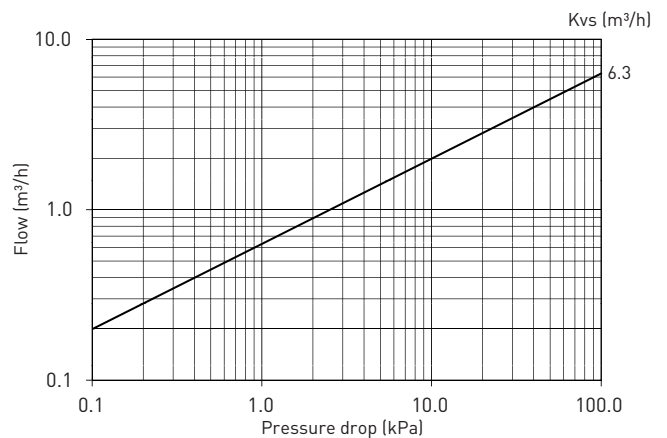

LK 851 - Male thread / Rotating nut

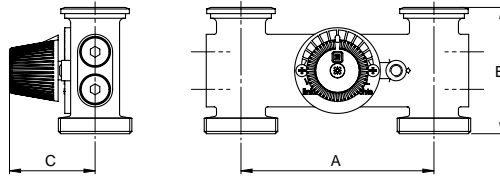

Article no.	Dimension	Kvs m ³ /h	A mm	B mm	C mm	Weight kg
181145	M 1½"	6.3	125	82	55	1.6

Two 1½" rotating nuts and two gaskets of EPDM are included in the delivery.

SPARE PARTS AND ACCESSORIES

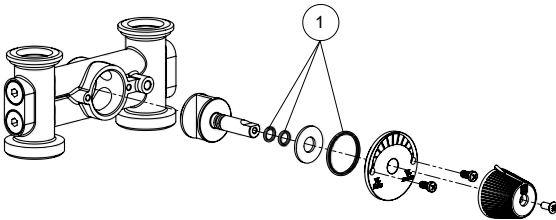

Article no.	Article	Position
187083	Sealing kit 851, DN 40	1

LK 525 MultiZone 3R



TECHNICAL DATA

Voltage	230 VAC, 50 Hz
Power consumption	5 VA
Working temperature	Min. 5 °C/Max. 80 °C (90 °C briefly)
Ambient temp.	Min. 5 °C/Max. 55 °C
Max. working pressure	1.0 MPa (10 bar)
Max. differential pressure	100 kPa (1 bar)
Leakage	< 0.1% of Kvs at 100 kPa
Angle of rotation	90°
Torque	5 Nm
Media	Water - Glycol/Ethanol mixture max. 50%
Operation time	110 s
Manual override	Yes
Electrical connection	Fixed wire
Signal connector	3 point SPDT
Protection type	IP 44
Protection class	II
Material, valve body	Brass EN 12165 CW617N
Material, external cover	Brass EN 12164 CW614N
Material, slide/spindle	PPS Composite
Cable specification	3 x 0.75 mm ²
Wire colours	Blue, brown, black
External insulation	PVC

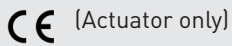

LK 525 MultiZone 3R is a 3-way valve that can be used as a mixing valve or as a diverting valve in heating systems.

The valve is constructed so that the leakage is less than 0.1% of Kvs at 100 kPa. It also has a split linear characteristic which means that the regulation is good even at low flows and capacities.

The valve must not be installed with the motor underneath the valve unit.

Please note that the motor can be installed in only one position.

The motor operates anti clockwise when the black conductor is powered and clockwise when the brown conductor is powered.

WIRING DIAGRAM

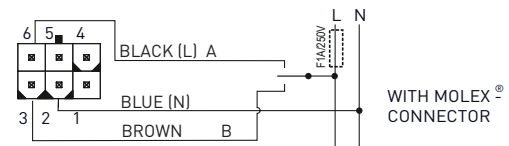
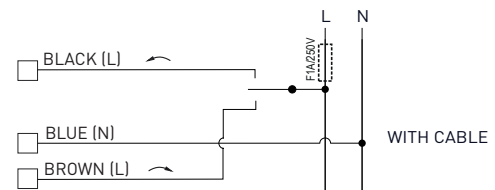

VALVE CHARACTERISTICS

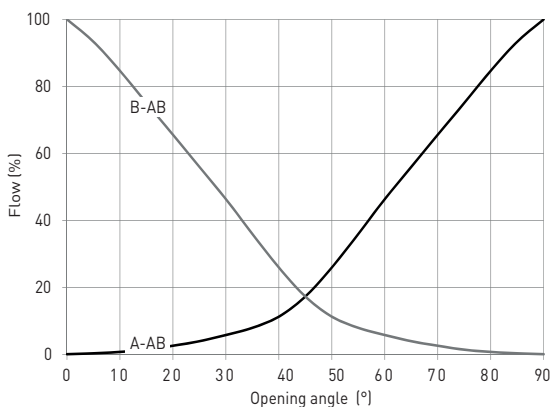

CAPACITY DIAGRAM

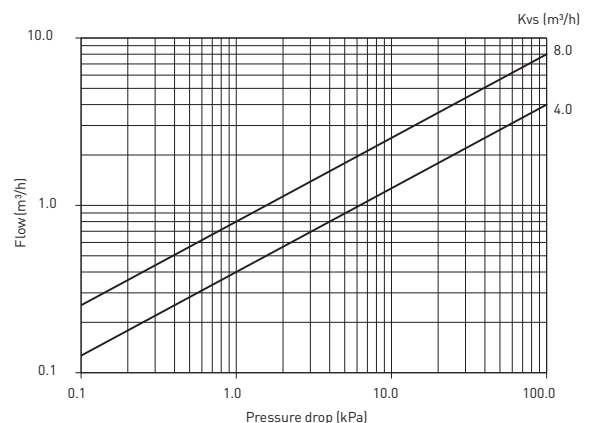

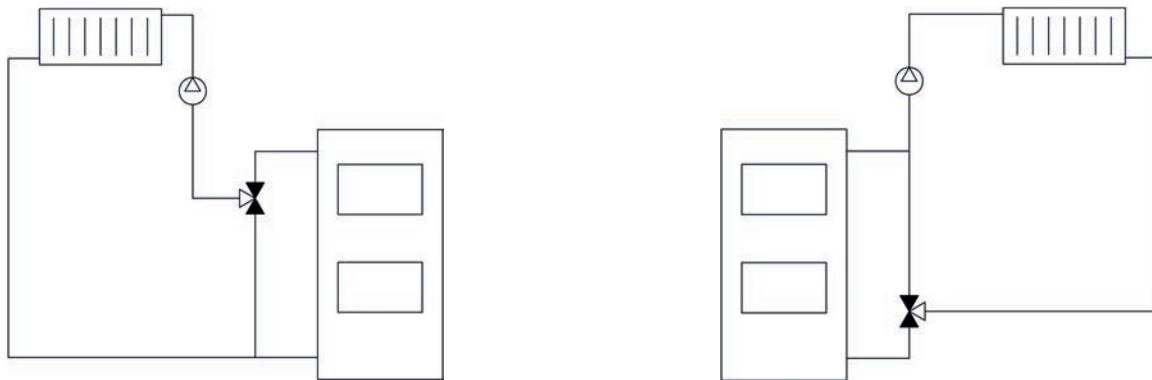

LK 525 3R - Male thread

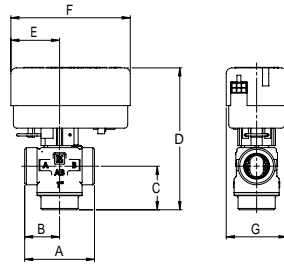

Article no.	Dim./Connection	Kvs m ³ /h	Voltage	Torque	Operation time	A mm	B mm	C mm	D mm	E mm	F mm	G mm	Weight kg
066350	M ¾"	4,0				70	35	39	132	46	109	58	0.3
066351	M 1"	4,0				62	31	39	132	46	109	58	0.3
066352	M 1¼"	4,0				74	37	40	133	46	109	58	0.6
066076	M ¾"	8,0				70	35	39	132	46	109	58	0.3
066077	M 1"	8,0				62	31	39	132	46	109	58	0.3
066078	M 1¼"	8,0				74	37	40	133	46	109	58	0.6
066127	1 m cable		230 V	5 Nm	110 s	109	58	45	73	85			0.4
066128	1 m cable 0-10 VDC		24 VAC	5 Nm	110 s	109	58	45	73	85			0.4

Other operation times on request.

LK 525 3R - Compression fitting

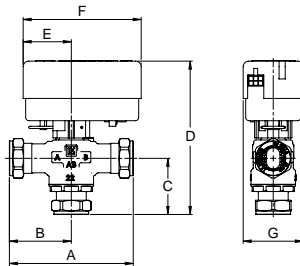

Article no.	Connection	Kvs m ³ /h	Voltage	Torque	Operation time	A mm	B mm	C mm	D mm	E mm	F mm	G mm	Weight kg
066353	22 mm	4,0				110	55	50	143	46	109	58	0.4
066354	28 mm	4,0				110	55	54	147	46	109	58	0.6
066079	22 mm	8,0				110	55	50	143	46	109	58	0.4
066080	28 mm	8,0				110	55	54	147	46	109	58	0.6
066127	1 m cable		230 V	5 Nm	110 s	109	58	45	73	85			0.4
066128	1 m cable 0-10 VDC		24 VAC	5 Nm	110 s	109	58	45	73	85			0.4

Other operation times on request.

SPARE PARTS AND ACCESSORIES



Article no.	Article	Position
187202	Insulation	1

LK Insulation



TECHNICAL DATA

Working temperature	Min. -20 °C/Max. 130 °C
Ambient temp.	Min. -20 °C/Max. 130 °C
Material, insulation	Expanded Polypropylene EPP
Thermal conductivity	0.035 W/mK,
Density	35 g/l

The LK Armatur insulation has been developed for ThermoVar® thermic valves, ThermoBac check valves, ThermoMix® mixing valves and MultiZone zone valves to provide effective protection against energy losses.

The insulation is available in three versions. One is designed for LK 823 ThermoVar®, one for valve types LK 820, 821 ThermoVar®, 822 ThermoBac, 840 and 841 ThermoMix® and one for 525 MultiZone 3V, Solar and Polar. In the standard design it fits LK 820, 821 ThermoVar® and LK 822 ThermoBac.

Cut-outs for spindle and valve port are easily done to adapt the insulation to LK 840 and 841 ThermoMix®, with or without an installed electronic controller.

The insulation's closing function allows a quick and easy mounting.

LK Insulation - LK 525 3V, Solar, Polar

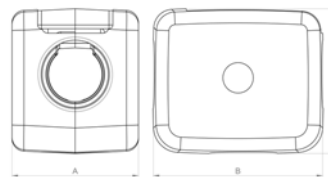

Article no.	Type	Dimension	A mm	B mm	C mm	D mm	Weight kg
187202	525 3V/R, Solar, Polar	G 1", G 1¼", G ¾", 22 mm, 28 mm	284	194	117	62	0.1

LK Insulation - LK 820, 821, 822, 840, 841

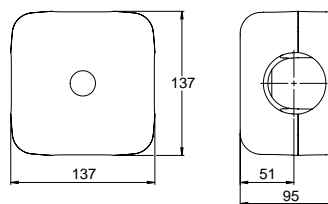

Article no.	Type	Dimension	DN	Weight kg
187107	820, 821, 822, 840, 841	M ¾", M 1", F ½", F ¾"	DN 15-20	0.1
187108	820, 821, 822, 840, 841	M 1¼", M 1½", F 1", F 1¼"	DN 25-32	0.1

LK Insulation - LK 823

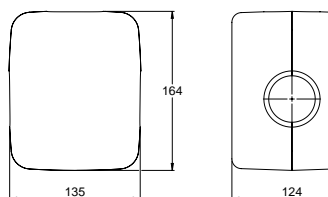

Article no.	Type	Dimension	DN	Weight kg
187109	823	M 1½", F 1", F 1¼"	25-32	0.1

Temperature Controllers



LK 100 SmartComfort CT

Electronic constant temperature controller for underfloor heating and solid fuel boilers.



LK 110 SmartComfort

Electronic weather compensated temperature controller for hydronic radiator and underfloor heating systems.



LK 120 SmartComfort

Electronic indoor temperature controller for hydronic radiator and underfloor heating systems.



LK 130 SmartComfort

Electronic, weather compensated, indoor temperature controller for hydronic radiator and underfloor heating systems.



LK 100 SmartComfort CT



TECHNICAL DATA

Primary voltage, adapter	100-240 VAC, 50/60 Hz
Secondary voltage, adapter	24 VDC
Power consumption	< 3 VA
Ambient temp.	Min. 0 °C/Max. 50 °C (in operation)
Control range	5 °C - 99 °C
Angle of rotation	90°
Torque	5 Nm
Protection class	IP 40



CONSTANT TEMPERATURE CONTROLLER

LK 100 SmartComfort CT is an electronic temperature controller designed to keep the supply temperature in underfloor heating systems or the return temperature to solid fuel boilers at a constant level.

LK 100 SmartComfort CT has an automatic choice of direction to adapt to the direction of the mixing valve. LED-indicators show if the controller is opening or closing the valve. The flow temperature is adjustable between 5 °C - 99 °C. The desired temperature is easily set with the push buttons marked "+" and "-". The selected value will be shown on the LED-display.

LK 100 SmartComfort CT is easy to install onto new as well as existing mixing valves. Mounting kits for installation onto mixing valves of other brands are available - see separate page.

The plug-in adapter provides quick and easy do-it-yourself installation. In case of a power outage the controller will keep its settings and the actuator will stop in its current position. By disengaging the controller, the mixing valve can be manually operated.

ITEMS INCLUDED

- Constant temperature controller
- Adapter 24 VDC
- Mounting kit for mixing valve
- Supply temperature sensor with 1 m cable

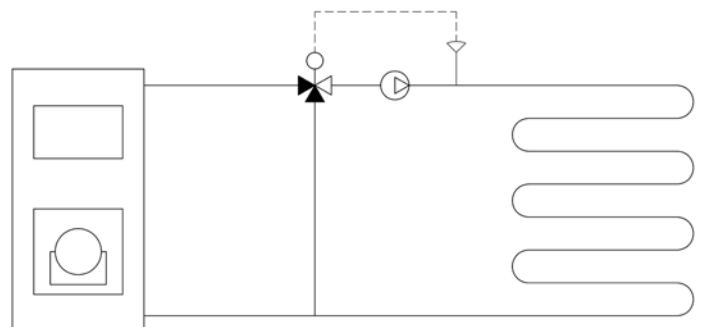
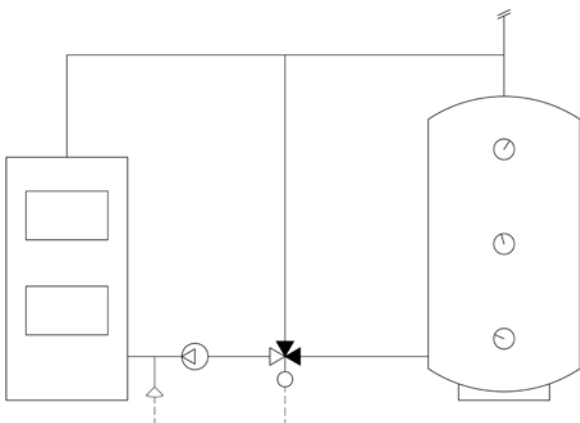

LK 100 SmartComfort CT

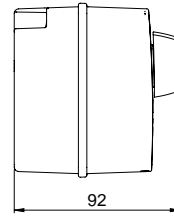
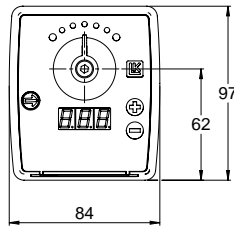

Article no.	Type	Weight kg
181242	LK 100 SmartComfort CT - EU	0.5
181248	LK 100 SmartComfort CT - EU	0.5
181249	LK 100 SmartComfort CT - US	0.5

SPARE PARTS AND ACCESSORIES



Article no.	Article	Position
187098	Constant temperature controller SmartComfort CT	1
025010	Adapter 24 VDC - EU	2
025011	Adapter 24 VDC - UK	2
025012	Adapter 24 VDC - US	2
181260	Mounting kit LK	3
025013	Supply temperature sensor, 1 m cable	4
025008	Extension cable for adapter, 1 m	5

LK 110 SmartComfort



TECHNICAL DATA

Primary voltage, adapter	100-240 VAC, 50/60 Hz
Secondary voltage, adapter	24 VDC
Power consumption	< 3 VA
Ambient temp.	Min. 0 °C /Max. 50 °C (in operation)
Min. supply temperature	5 °C - 40 °C
Max. supply temperature	20 °C - 99 °C
Curve slope	1.0 - 9.9
Parallel displacement	± 10 °C
Angle of rotation	90°
Torque	5 Nm
Protection class	Actuator IP 40



ITEMS INCLUDED

- Temperature controller
- Adapter 24 VDC
- Mounting kit for mixing valve
- Supply temperature sensor with 1 m cable
- Outdoor temperature sensor with 15 m cable and protective casing



WEATHER COMPENSATED TEMPERATURE CONTROLLER

LK 110 SmartComfort is an electronic weather compensated temperature controller for hydronic radiator and underfloor heating systems. By measuring the supply and outdoor temperatures LK 110 SmartComfort regulates the mixing valve to provide the system with the exact amount of heat required in the building at any given time. The current supply and outdoor temperatures can be read on the controller display.

LK 110 SmartComfort has an automatic choice of direction to adapt to the direction of the mixing valve. LED-indicators show if the controller is opening or closing the valve. The supply temperature can be limited with a minimum and a maximum value. Symbols on the controller show the chosen function and the LED display shows the setting or value of the function. Adjustments are easily made with the push buttons marked “+” and “-”.

Dependent on the dimension of the heating system and the insulation of the building, the heating curve may need to be adjusted in order to achieve the desired room temperature. The curve slope and the parallel displacement are easily adjusted with the push buttons.

LK 110 SmartComfort is easy to install onto new as well as existing mixing valves. Mounting kits for installation onto mixing valves of other brands are available - see separate page.

The plug-in adapter provides quick and easy do-it-yourself installation. In case of a power outage the controller will keep its settings and the actuator will stop in its current position. By disengaging the controller, the mixing valve can be manually operated.

For further energy saving a pump control, SmartComfort PC, can easily be connected to the controller - see under Accessories. SmartComfort PC stops the circulating pump when no heat is required and exercises pump every two days, thus eliminating the risk of pump stalling after an intermission.

Room temperature unit SmartComfort RT alternatively Smart-Comfort RTW is available as an accessory. For more information, please see product sheets for LK 120 and LK 130 SmartComfort.

CURVE SLOPE

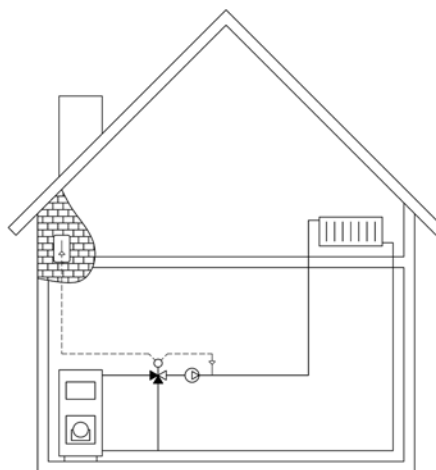
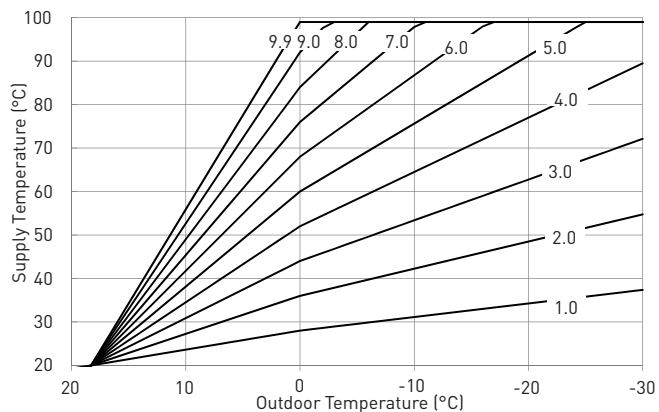

LK 110 SmartComfort

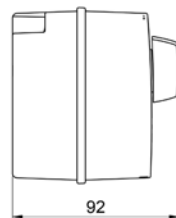
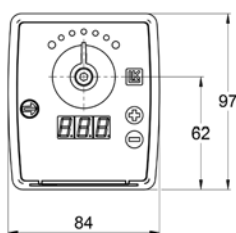

Article no.	Type	Weight kg
181243	LK 110 SmartComfort - EU	0.7
181250	LK 110 SmartComfort - UK	0.7
181251	LK 110 SmartComfort - US	0.7

SPARE PARTS AND ACCESSORIES



Article no.	Article	Position
187099	Temperature controller SmartComfort	1
025010	Adapter 24 VDC - EU	2
025011	Adapter 24 VDC - UK	2
025012	Adapter 24 VDC - US	2
181260	Mounting kit LK	3
025013	Supply temperature sensor, 1 m cable	4
025014	Outdoor temperature sensor, 15 m cable	5
025020	Protective casing for outdoor temperature sensor	6
187096	Room temperature unit SmartComfort RT	7
025025	Cable for SmartComfort RT, 15 m	8
025026	Extension cable for SmartComfort RT, 15 m	9
187113	Room temperature unit SmartComfort RTW with wireless receiver	10
187095	Pump control SmartComfort PC	11
025027	Extension cable for outdoor temperature sensor, 15 m	12
025008	Extension cable for adapter, 1 m	13

LK 120 SmartComfort



TECHNICAL DATA

Primary voltage, adapter	100-240 VAC, 50/60 Hz
Secondary voltage, adapter	24 VDC
Power consumption	< 3 VA
Ambient temp.	
Actuator	Min. 0 °C/Max. 50 °C (in operation)
Room Temperature Unit	Min. 0 °C/Max. 40 °C
Min. supply temperature	5 °C - 40 °C
Max. supply temperature	20 °C - 99 °C
Control range	Min. 5 °C/Max. 35 °C
Angle of rotation	90°
Torque	5 Nm
Protection class	Actuator IP 40 Room Temperature Unit IP 20



ITEMS INCLUDED

- Temperature controller
- Adapter 24 VDC
- Mounting kit for mixing valve
- Supply temperature sensor with 1 m cable
- Room temperature unit SmartComfort RT with 15 m cable or Room temperature unit SmartComfort RTW with wireless receiver



INDOOR TEMPERATURE CONTROLLER

LK 120 SmartComfort is an electronic indoor temperature controller for hydronic radiator and underfloor heating systems. By measuring the supply and indoor temperatures LK 120 SmartComfort regulates the mixing valve to provide the system with the exact amount of heat required in the building at any given time.

LK 120 SmartComfort has an automatic choice of direction to adapt to the direction of the mixing valve. LED-indicators show if the controller is opening or closing the valve. The supply temperature can be limited with a minimum and a maximum value. Symbols on the controller show the chosen function and the LED display shows the setting or value of the function. Adjustments are easily made with the push buttons marked “+” and “-”.

LK 120 SmartComfort is delivered with a room temperature unit allowing easy setting of the desired indoor temperature. The room temperature unit is available in two versions; with fixed cable SmartComfort RT or wireless receiver SmartComfort RTW. For further energy saving and increased comfort there are nine preset programs with scheduled temperature changes. You can also create your own programs. Additional functions such as holiday and timer settings are available.

After a temperature setback the room temperature unit applies a booster function which briefly increases the supply temperature in order to quickly reach the desired room temperature. Should the room temperature unit sense a sudden change in temperature, such as when airing a room, the unit disregards this change for the following half hour.

The room temperature unit is equipped with a connection port for external control, such as via a GSM modem, making it possible to activate a preset temperature change via mobile phone.

LK 120 SmartComfort is easy to install onto new as well as existing mixing valves. Mounting kits for installation onto mixing valves of other brands are available - see separate page.

The plug-in adapter provides quick and easy do-it-yourself installation. In case of a power outage the controller will keep its settings and the actuator will stop in its current position. By disengaging the controller, the mixing valve can be manually operated.

For further energy saving a pump control, SmartComfort PC, can easily be connected to the controller - see under Accessories. SmartComfort PC stops the circulating pump when no heat is required and exercises pump every two days, thus eliminating the risk of pump stalling after an intermission.

An outdoor temperature sensor is available as an accessory. For more information, please see product sheets for LK 110 and LK 130 SmartComfort.

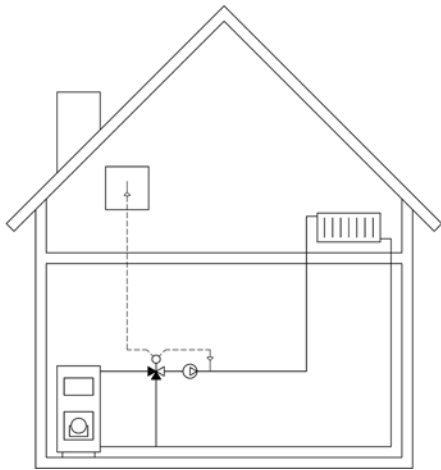

DISPLAY - ROOM TEMPERATURE UNIT

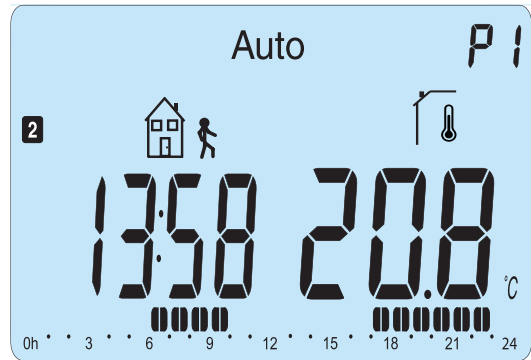

LK 120 SmartComfort

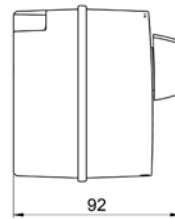
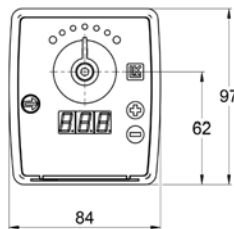

Article no.	Type	Weight kg
181244	LK 120 SmartComfort - EU, with room temperature unit SmartComfort RT - 15 m cable	0.8
181245	LK 120 SmartComfort - EU, with room temperature unit SmartComfort RTW - wireless receiver	0.7
181252	LK 120 SmartComfort - UK, with room temperature unit SmartComfort RT - 15 m cable	0.8
181254	LK 120 SmartComfort - UK, with room temperature unit SmartComfort RTW - wireless receiver	0.7
181253	LK 120 SmartComfort - US, with room temperature unit SmartComfort RT - 15 m cable	0.8

SPARE PARTS AND ACCESSORIES



Article no.	Article	Position
187099	Temperature controller SmartComfort	1
025010	Adapter 24 VDC - EU	2
025011	Adapter 24 VDC - UK	2
025012	Adapter 24 VDC - US	2
181260	Mounting kit LK	3
025013	Supply temperature sensor, 1 m cable	4
025014	Outdoor temperature sensor, 15 m cable	5
025020	Protective casing for outdoor temperature sensor	6
187096	Room temperature unit SmartComfort RT	7
025025	Cable for SmartComfort RT, 15 m	8
025026	Extension cable for SmartComfort RT, 15 m	9
187113	Room temperature unit SmartComfort RTW with wireless receiver	10
187095	Pump control SmartComfort PC	11
025027	Extension cable for outdoor temperature sensor, 15 m	12
025008	Extension cable for adapter, 1 m	13

LK 130 SmartComfort



TECHNICAL DATA

Primary voltage, adapter	100-240 VAC, 50/60 Hz
Secondary voltage, adapter	24 VDC
Power consumption	< 3 VA
Ambient temp.	
Actuator	Min. 0 °C/Max. 50 °C (in operation)
Room Temperature Unit	Min. 0 °C/Max. 40 °C
Min. supply temperature	5 °C - 40 °C
Max. supply temperature	20 °C - 99 °C
Control range	Min. 5 °C/Max. 35 °C
Curve slope	1.0 - 9.9
Parallel displacement	± 10 °C
Angle of rotation	90°
Torque	5 Nm
Protection class	Actuator IP 40, Room Temperature Unit IP 20



WEATHER COMPENSATED INDOOR TEMPERATURE CONTROLLER

LK 130 SmartComfort is an electronic, weather compensated, indoor temperature controller for hydronic radiator and under-floor heating systems. By measuring the supply, outdoor and indoor temperatures LK 130 SmartComfort regulates the mixing valve to provide the system with the exact amount of heat required in the building at any given time.

LK 130 SmartComfort has an automatic choice of direction to adapt to the direction of the mixing valve. LED-indicators show if the controller is opening or closing the valve. The supply temperature can be limited with a minimum and a maximum value. Symbols on the controller show the chosen function and the LED display shows the setting or value of the function. Adjustments are easily made with the push buttons marked "+" and "-".

Dependent on the dimension of the heating system and the insulation of the building, the heating curve may need to be adjusted in order to achieve the desired room temperature. The curve slope and the parallel displacement are easily adjusted with the push buttons.

LK 130 SmartComfort is delivered with a room temperature unit allowing easy setting of the desired indoor temperature. The room temperature unit is available in two versions; with fixed cable SmartComfort RT or wireless receiver SmartComfort RTW. For further energy saving and increased comfort there are nine preset programs with scheduled temperature changes. You can also create your own programs. Additional functions such as holiday and timer settings are available. The current outdoor temperature can be read on the room temperature unit.

After a temperature setback the room temperature unit applies a booster function which briefly increases the supply temperature in order to quickly reach the desired room temperature. Should the room temperature unit sense a sudden change in temperature, such as when airing a room, the unit disregards this change for the following half hour.

The room temperature unit is equipped with a connection port for external control, such as via a GSM modem, making it possible to activate a preset temperature change via mobile phone.

LK 130 SmartComfort is easy to install onto new as well as existing mixing valves. Mounting kits for installation onto mixing valves of other brands are available - see separate page.

The plug-in adapter provides quick and easy do-it-yourself installation. In case of a power outage the controller will keep its settings and the actuator will stop in its current position. By disengaging the controller, the mixing valve can be manually operated.

For further energy saving a pump control, SmartComfort PC, can easily be connected to the controller - see under Accessories. SmartComfort PC stops the circulating pump when no heat is required and exercises pump every two days, thus eliminating the risk of pump stalling after an intermission.

ITEMS INCLUDED

- Temperature controller
- Adapter 24 VDC
- Mounting kit for mixing valve
- Supply temperature sensor with 1 m cable
- Outdoor temperature sensor with 15 m cable and protective casing
- Room temperature unit SmartComfort RT with 15 m cable or Room temperature unit SmartComfort RTW with wireless receiver



CURVE SLOPE

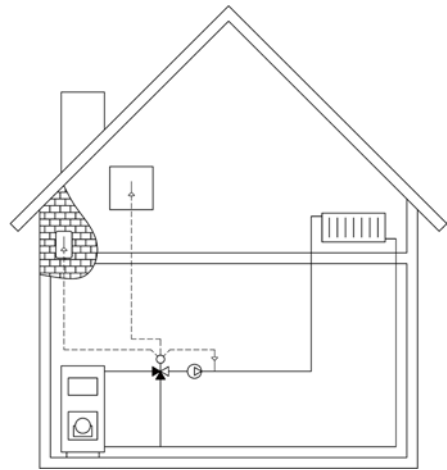
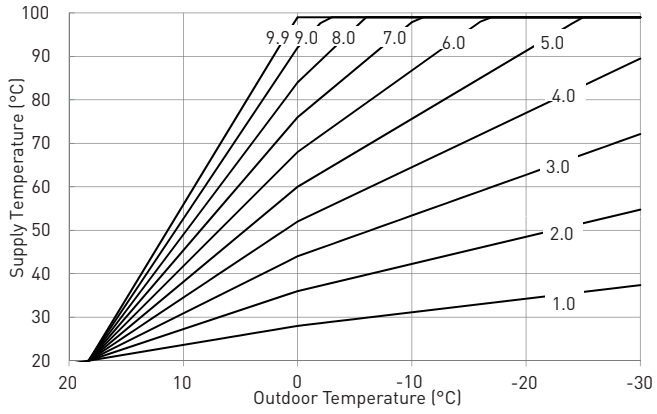

DISPLAY - ROOM TEMPERATURE UNIT

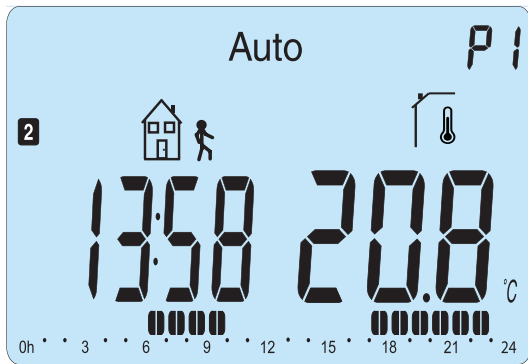

LK 130 SmartComfort

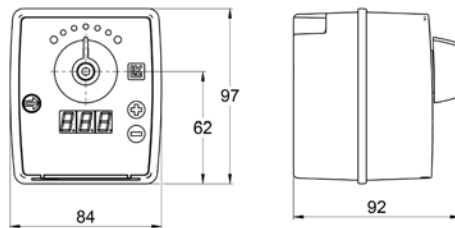

Article no.	Type	Weight kg
181246	LK 130 SmartComfort - EU, with room temperature unit SmartComfort RT - 15 m cable	1.0
181247	LK 130 SmartComfort - EU, with room temperature unit SmartComfort RTW - wireless receiver	0.9
181256	LK 130 SmartComfort - UK, with room temperature unit SmartComfort RT - 15 m cable	1.0
181258	LK 130 SmartComfort - UK, with room temperature unit SmartComfort RTW - wireless receiver	0.9
181257	LK 130 SmartComfort - US, with room temperature unit SmartComfort RT - 15 m cable	1.0

SPARE PARTS AND ACCESSORIES



Article no.	Article	Position
187099	Temperature controller SmartComfort	1
025010	Adapter 24 VDC - EU	2
025011	Adapter 24 VDC - UK	2
025012	Adapter 24 VDC - US	2
181260	Mounting kit LK	3
025013	Supply temperature sensor, 1 m cable	4
025014	Outdoor temperature sensor, 15 m cable	5
025020	Protective casing for outdoor temperature sensor	6
187096	Room temperature unit SmartComfort RT	7
025025	Cable for SmartComfort RT, 15 m	8
025026	Extension cable for SmartComfort RT, 15 m	9
187113	Room temperature unit SmartComfort RTW with wireless receiver	10
187095	Pump control SmartComfort PC	11
025027	Extension cable for outdoor temperature sensor, 15 m	12
025008	Extension cable for adapter, 1 m	13

Valve Actuators



LK 941 EasyMix

Actuator for operation of mixing valves.



LK 950 Valve Actuator

Actuator for operation of mixing valves.



LK 941 EasyMix



TECHNICAL DATA

Voltage	230 VAC 50 Hz 24 VAC 50 Hz
Power consumption	6 VA
Ambient temp.	Min. 0 °C/Max. 55 °C
Angle of rotation	90° electrically limited
Torque	15 Nm
Operation time	73 s/147 s
Direction of operation	Selectable
Position indication	Reversible scale
Manual override	Disengagement of gears
Electrical connection	Cable 1 m
Signal connector	3-point SPDT 0-10 VDC/4-20 mA
Protection type	IP 44
Protection class	II



LK 941 EasyMix is a series of valve actuators. Depending on model the actuator can be operated by a controller with a 3-point SPDT output or a proportional 0-10 V / 4-20 mA output. The angle of rotation is electrically limited to 90°.

The actuator can be mounted in any position except below the valve. The actuator is mounted directly onto the valve spindle with a screw. An anti-rotation bolt keeps the actuator in position. When needed, the actuator can be put into manual mode by pressing and turning the button on the housing cover 90° to disengage the gears. The actuator can now be put in any position by turning the handle on the front. The position is indicated on the reversible scale.

LK 941 EasyMix fits most mixing valves on the market.

LK 941 EasyMix

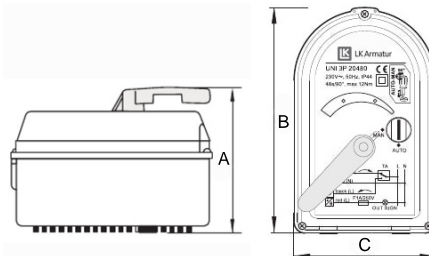

Article no.	Connection	Voltage	Torque	Operation time	A mm	B mm	C mm	Weight kg
066129	1 m cable	230 VAC	15 Nm	73 s	92,5	125	78	0.6
066132	1 m cable	230 VAC	15 Nm	147 s	92,5	125	78	0.6
066133	1 m cable. 0 - 10 VDC	24 VDC/AC	15 Nm	73 s	92,5	125	78	0.6

LK 950 Valve Actuator



TECHNICAL DATA

Voltage	230 VAC 50/60 Hz 24 VAC 50/60 Hz, 24 VDC/AC 50/60 Hz
Power consumption	1.5 - 3.5 W
Ambient temp.	Min. 0 °C/Max. 50 °C
Angle of rotation	90°, electrically limited
Torque	5/10 Nm
Operation time	70/140/280 s
Direction of operation	Selectable
Position indication	Reversible scale
Manual override	Disengagement of gears
Electrical connection	Cable 1.5 m, 3 x 0.75 mm ²
Protection type	IP 40
Protection class	II (Double Insulated) III (SELV)
Dimensioning*	1.5 - 3.5 VA



*Depending on model

LK 950 is a series of valve actuators. Depending on model the actuator can be operated by a controller with a 3-point SPDT output or a proportional 2 (0) - 10 V output. The actuator is fitted with limit switches. The angle of rotation is electrically limited to 90°. An additional auxiliary adjustable switch can be ordered as an accessory.

The actuator can be mounted in any position except below the valve. The actuator is mounted directly onto the valve spindle with a screw. An anti-rotation bolt keeps the actuator in position. When needed, the actuator can be put into manual mode by turning the button on the housing cover 90° clockwise to disengage the gears. The actuator can now be put in any position by turning the handle on the front. The position is indicated on the reversible scale.

LK 950 fits most mixing valves. Mounting kits for mixing valves of other brands are available - please see the product sheet for Mounting Kits.

LK 950 Valve Actuator

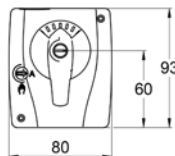

Article no.	Voltage	Torque	Operation time	Note	Weight kg
180742	24 VAC	5 Nm	70 s	Mounting kit is not included	0.5
180744	24 VAC	5 Nm	140 s	Mounting kit is not included	0.5
180756	230 VAC	5 Nm	70 s		0.5
180759	230 VAC	5 Nm	140 s		0.5
180760	230 VAC	5 Nm	140 s	3 m cable	0.5
180762	230 VAC	10 Nm	280 s		0.5
180763	230 VAC	10 Nm	280 s	3 m cable	0.5
180764	230 VAC	10 Nm	140 s		0.5
181208	230 VAC	5 Nm	280 s	incl. auxiliary switch	0.5
180978	230 VAC	5 Nm	280 s		0.5
180765	24 VDC/AC	5 Nm	70 s	2 (0) - 10 V without cable	0.5

SPARE PARTS AND ACCESSORIES



Article no.	Article	Position
180739	Mounting kit 950	1
180741	Auxiliary switch 950	2
026223	Cable for auxiliary switch, 1.5 m	3

Mounting Kits



Mounting kits for mixing valves of other brands



Article no.	Type	Valve brand
187086	440, 450, 451, 460, 475, 476, W28	Barberi
187084	DR-GMLA, DR-GFLA (DN 15-35)	Centra
187087	DR-MA (DN 15-50)	Centra
180746		Danfoss
180403	VRG, VRB (DN 15-50)	ESBE
187088	BR80 SMD/SMV	Holter
187094	SERIES 2, VCI 31 (DN 20-40)	Landis & Staefa
187089	SERIES 1, B3F (DN 20-40)	Landis & Staefa
187090		Lazzari
187091	3W, 4W	Lovato
187092	MB	Satchwell
187093	MBF	Satchwell
180747		Siemens
180740	3W, 4W, H	Wita / Oventrop / Meibes

Differential Temperature Controllers



LK 150 SmartSol

Electronic differential temperature controller for solar heating systems.



LK 160 SmartBio®

Electronic differential temperature controller for heating systems with storage tanks.



LK 162 SmartStove

Biomass controller for multi-fuel water containing stoves with buffer tanks



LK 150 SmartSol



TECHNICAL DATA

Voltage	230 VAC, 50 Hz
Power consumption	3.5 VA
Relay output	Max. 240 VAC, 4 A
Triac outputs	230 VAC ± 10%, 1 A, 200 VA
High-efficiency pump	Analog output 0 -10 V, max. 10 mA PWM output 100 Hz - 2 kHz
Sensors	PT 1000
Display	TFT backlit colour display 47 x 35 mm
Protection type	IP 20
Protection class	II



ITEMS INCLUDED IN ARTICLE NO. 181795

- Differential temperature controller LK 150 SmartSol Access
- Collector sensor PT 1000 - 3 m cable
- Two tank sensors PT 1000 - 4 m cable

ITEMS INCLUDED IN ARTICLE NO. 181796

- Differential temperature controller LK 150 SmartSol Top
- Collector sensor PT 1000 - 3 m cable
- Three tank sensors PT 1000 - 4 m cable

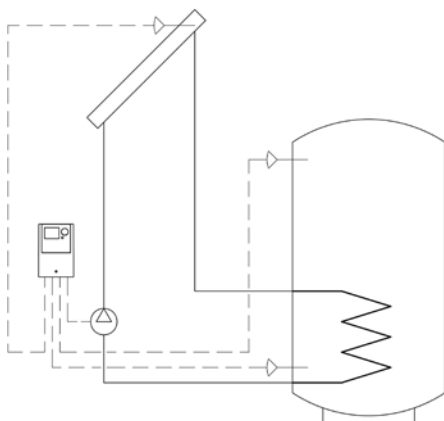

LK 150 SmartSol is an electronic differential temperature controller for solar heating systems. The controller has, depending on model, 20 or 24 preset hydraulic systems for different solar heating systems. The chosen hydraulic system and operating status is shown on the backlit colour display. Controls and settings are easily carried out using the rotating knob and the esc-button. LK 150 SmartSol can handle high efficiency pumps.

FEATURES, MODEL ACCESS AND TOP

- Two speed controlled outputs for circulating pumps or valves
- Output for high efficiency pump
- Floating relay output
- Operation time counter for relay outputs
- Pump exercise
- Balancing of sensors
- Overheating protection for collectors and tanks
- Collector and tank cooling
- Anti-freeze
- Collector defrosting
- Tube collector function
- Additional heat
- Quick-charging
- Holiday function
- Integrated energy measuring
- Integrated clock with date
- Automatic summer/winter time
- Graphic, multilingual colour display
- Self-explanatory menu and user guide
- USB port for PC connection
- SD card slot for data logging (micro SD)
- One input for analog vortex flow sensor

FEATURES, MODEL ACCESS

- 20 hydraulic systems
- Terminal block for four PT 1000 sensors

FEATURES, MODEL TOP

- 24 hydraulic systems
- Terminal block for six PT 1000 sensors

LK 150 SmartSol

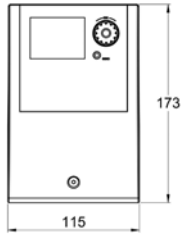

Article no.	Article	Weight kg
181795	150 SmartSol Access	0.7
181796	150 SmartSol Top	0.7

SPARE PARTS AND ACCESSORIES



Article no.	Article	Position
025041	Differential temperature controller SmartSol Access	1
025042	Differential temperature controller SmartSol Top	1
181187	Collector sensor PT 1000 Ø 5 mm - 3 m cable	2
181186	Tank sensor PT 1000 Ø 6 mm - 4 m cable	3
180812	Sensor pocket 150 mm	4
025039	Micro SD Card 2 GB	5

LK 160 SmartBio®



TECHNICAL DATA

Voltage	230 VAC, 50 Hz
Power consumption	3.5 VA
Relay output	Max. 240 VAC, 4 A
Triac outputs	230 VAC ± 10%, 1 A, 200 VA
High-efficiency pump	Analog output 0 -10 V, max. 10 mA PWM output 100 Hz - 2 kHz
Sensors	PT 1000
Display	TFT backlit colour display 47 x 35 mm
Protection type	IP 20
Protection class	II



LK 160 SmartBio® is an electronic differential temperature controller with several preset hydraulic systems for energy efficiency in heating systems with storage tanks. The chosen hydraulic system and operation status is shown on the backlit colour display. Controls and settings are easily carried out using the rotating knob and the esc-button. LK 160 SmartBio® can handle high efficiency pumps.

LK 160 SmartBio® can also activate an immersion heater or burner if the temperature in the primary tank falls below the selected value. The additional heat has a sophisticated delay function that further adds to the efficiency of the system.

FEATURES

- Several hydraulic systems
- Two outputs for circulating pumps
- Pump exercise
- Floating relay output
- Sensor balancing
- Adjustable delay function for additional heat
- Graphic, multilingual colour display with time and date
- User-friendly menu system
- USB port for PC connection
- SD card slot for data logging (micro SD)
- Speed control possible for two circulation pumps via PWM signal

HYDRAULIC SYSTEM 1

Hydraulic system 1 is intended for storage tank systems with a primary and secondary tank. LK 160 SmartBio® controls the two circulating pumps between the tanks. When the primary tank is fully charged the charge pump starts at the chosen temperature to fill the secondary tank. When the temperature in the primary tank falls, the recharging pump starts and transfers energy back to the primary tank.

HYDRAULIC SYSTEM 1.1:

In order to prevent self-circulation in both directions LK 970 ThermoBac DB double acting check valve should be mounted between the circulating pumps - see under spare parts and accessories.

HYDRAULIC SYSTEM 1.2:

The LK 824 ThermoVar® is a thermic valve with double acting check valve function which ensures a high return temperature to the solid fuel boiler, thus increasing the efficiency of the system - see spare parts and accessories

HYDRAULIC SYSTEM 2

Hydraulic system 2 is intended for storage tank systems in which heating water and domestic hot water are taken from a secondary tank. Heat is to be transferred from the main tank to the secondary tank. By measuring the temperature difference between the tanks LK 160 SmartBio® controls the charge pump.

HYDRAULIC SYSTEM 3

Hydraulic system 3 is intended for the charging of a storage tank with a pellet, oil or gas fired burner. By measuring the temperatures in the tank and boiler LK 160 SmartBio® controls the burner and charge pump.

HYDRAULIC SYSTEM 4

Hydraulic system 4 is intended for storage tank systems with domestic hot water tanks. This system gives priority to the heat in the upper part of the main tank. This enables a fast transfer of heat to the domestic hot water tank. LK 160 SmartBio® controls the charge pump to the domestic hot water tank, the zone valve of the main tank and the circulator in the heating loop.

STANDARD KIT

- Differential temperature controller LK 160 SmartBio®
- Three sensors PT 1000 - 4 m cable



KIT FOR HYDRAULIC SYSTEM 1.1

- Differential temperature controller LK 160 SmartBio®
- Three sensors PT 1000 - 4 m cable
- Two circulating pumps Grundfos Alpha 2 L 25-60
- Two ball valves 1"
- Check valve with double acting flow LK 970 ThermoBac DB
- Four gaskets EPDM



HYDRAULIC SYSTEM 1.1

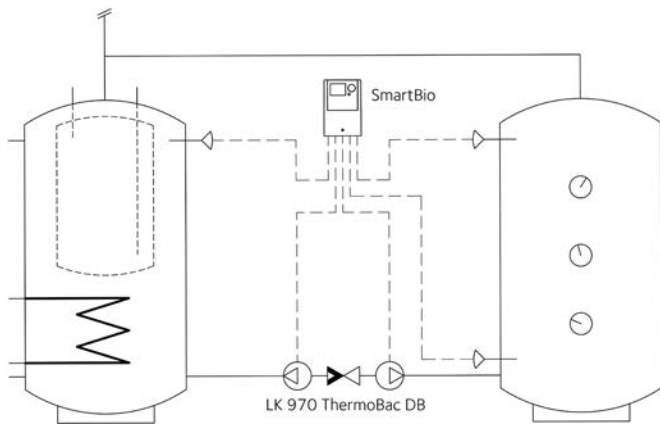

HYDRAULIC SYSTEM 1.2

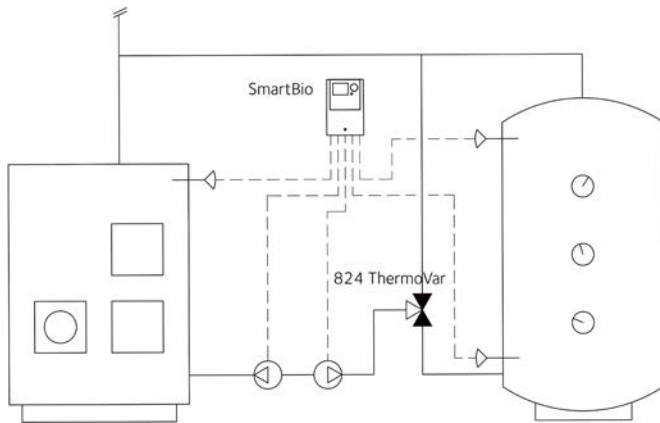

HYDRAULIC SYSTEM 3

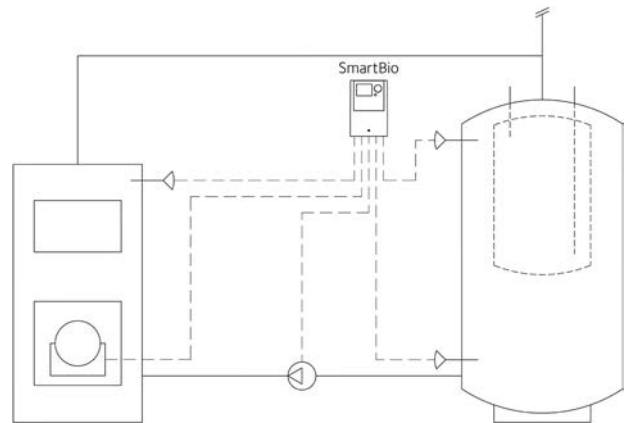

HYDRAULIC SYSTEM 2

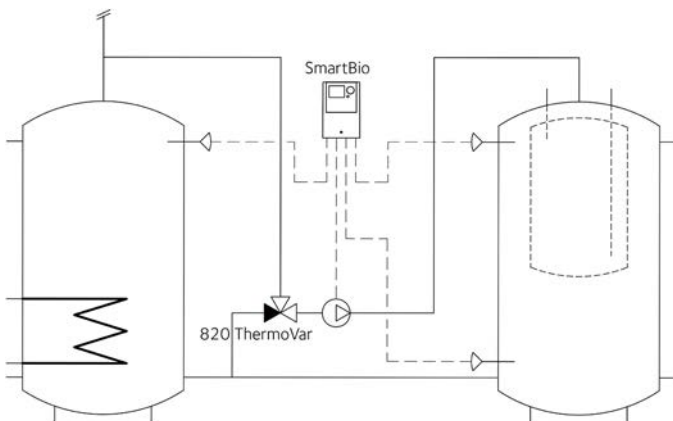

HYDRAULIC SYSTEM 4

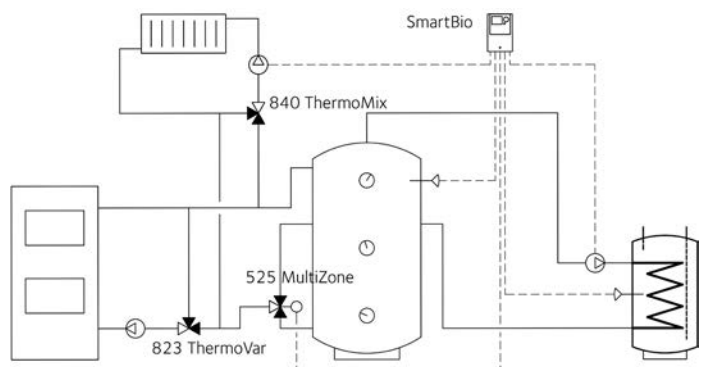

LK 160 SmartBio®

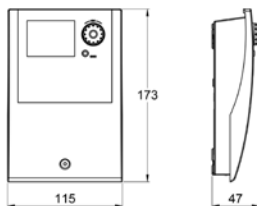

Article no.	Article	Weight kg
181234	LK 160 SmartBio standard kit	0.7
181233	160 SmartBio® kit for hydraulic system 1	6.2

SPARE PARTS AND ACCESSORIES

	Article no.	Article	Position
	025017	Differential temperature controller SmartBio®	1
	181186	Tank sensor PT 1000 Ø 6 mm - 4 m cable	2
	187129	Circulating pump Grundfos Alpha 2 L 25-60	3
	187017	Ball valve F 1"	4
	187018	Ball valve F 1 1/4"	5
	187019	Ball valve 28 mm	6
	180487	Check valve with double acting flow LK 970 ThermoBac DB	7
	180812	Sensor pocket 150 mm	8
	013025	Gasket EPDM 1 1/2" - Ø44 x Ø27 x 2 mm	9
	181553	LK 824 ThermoVar® G 1 1/2", 45 °C	10
	181554	LK 824 ThermoVar® G 1 1/2", 55 °C	10
	181555	LK 824 ThermoVar® G 1 1/2", 61 °C	10
	181556	LK 824 ThermoVar® G 1 1/2", 66 °C	10
	181557	LK 824 ThermoVar® G 1 1/2", 72 °C	10
	180810	Connection M 1 1/2" x M 1 1/2", L30 mm	11
	025039	Micro SD Card 2 GB	12

LK 162 SmartStove®



TECHNICAL DATA

Voltage	230 VAC, 50 Hz
Power consumption	3,5 VA
Relay output	Max. 240 VAC, 4 A
Triac outputs	230 VAC ± 10%, 1 A, 200 VA
High-efficiency pump	Analog output 0 -10 V, max. 10 mA PWM output 100 Hz - 2 kHz
Sensors	PT 1000
Display	TFT backlit colour display
Protection type	IP 20
Protection class	II



LK 162 SmartStove® is a biomass controller for multi-fuel water containing stoves with buffer tanks. The controller has a number of preset hydraulic systems for different installations.

For indication of the active hydraulic system and the current temperatures in stove and buffer tank the controller is equipped with a coloured full graphics display which is permanently backlit.

LK 162 SmartStove® can control the charge pump of a loading unit, the circulator in a heating loop, high-efficiency pumps and an additional heat source.

FEATURES

- Acoustic alarm and indication in the display if over temperature should occur in stove or buffer tank
- A temperature sensor in the stove controls the charge pump of the loading unit which means that no fluegas thermostat is needed
- Pump delay function. The charge pump in the loading unit does not start until the stove has reached a certain temperature. This saves energy, prevents tarring and considerably prolongs the life-time of the stove
- Dynamic pump control can be activated when the loading unit is equipped with a speed-controlled pump. The pumpcontrol keeps the flow at a constant temperature
- Economy or comfort mode can be selected to optimize energy efficiency in the potable hot water boiler and/or in the heating system
- Controls an additional heat source
- Delay function for the additional heat source
- 7 hydraulic systems which can be mirrored
- 2 outputs for speed-controlled pumps with PWM and/ or analogue signal
- 6 terminals for temperature sensors
- 1 floating change-over contact
- SD card slot for data logging and software update
- USB for PC connection
- Legionella prevention
- Pump exercise
- Freeze protection

HYDRAULIC SYSTEM

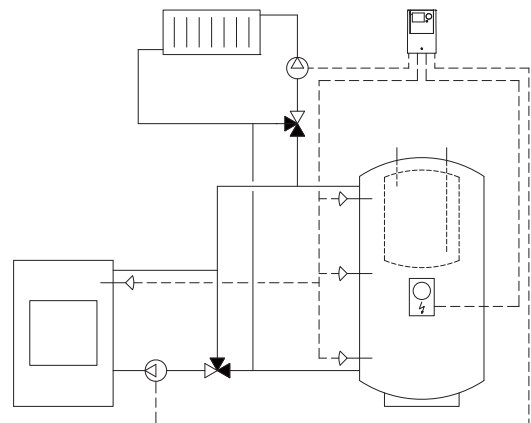

HYDRAULIC SYSTEM

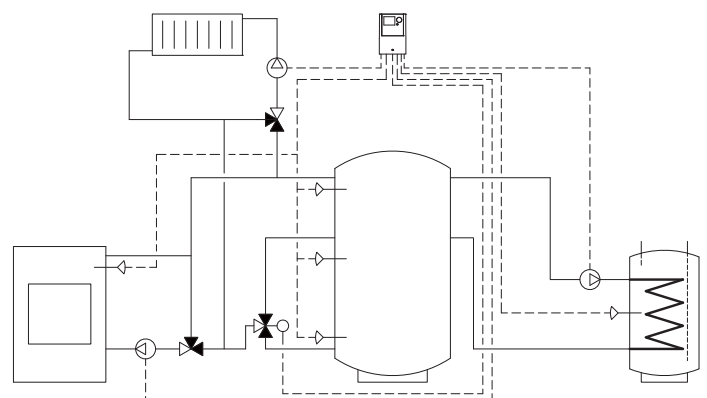

LK 162 SmartStove®

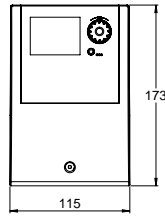

Article no.	Article	Weight kg
181708	LK 162 SmartStove®	0.7

Four sensors included (PT 1000 - 4 m cable).

SPARE PARTS AND ACCESSORIES



Article no.	Article	Position
181186	Tank sensor PT 1000 Ø 6 mm - 4 m cable	1
180812	Sensor pocket 150 mm	2
025039	Micro SD Card 2 GB	3

Solar Pump Units



LK 201 SmartSolar

Compact single-pipe control unit for solar heating applications.



LK 202 SmartSolar

Compact dual-pipe control unit for solar heating applications.

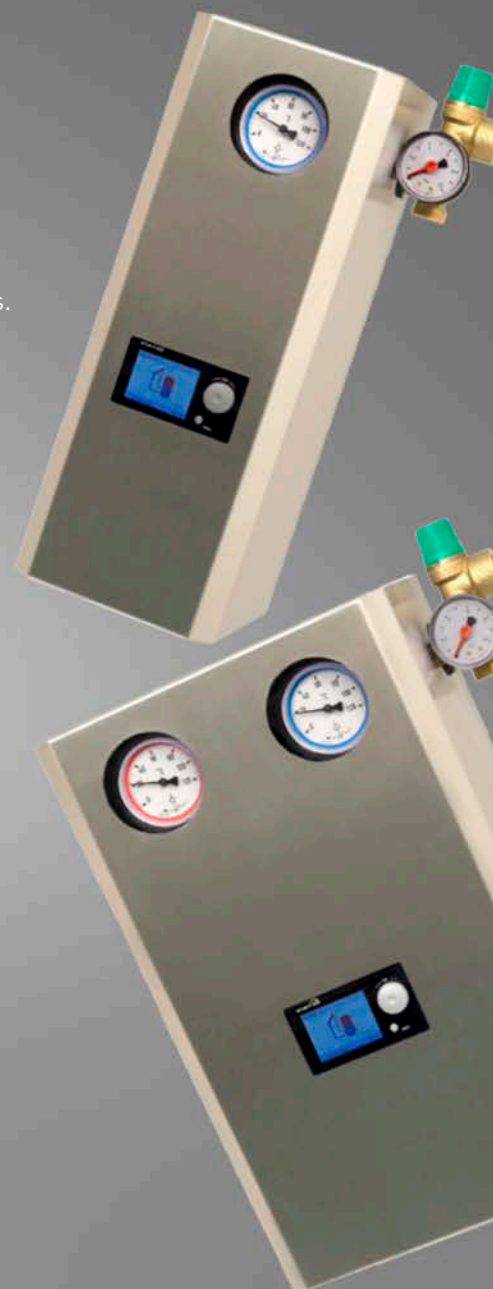

LK 201 SmartSolar



TECHNICAL DATA

Voltage	230 VAC \pm 10%, 50 Hz
Working temperature	Min. 0°C/Max. 120°C (150°C briefly)
Max. working pressure	1.0 MPa (10 bar)
Operating pressure	0.6 MPa (6 bar)
Media	Water - Propylene glycol mixture max. 50%
Thread standard	G - male thread
Circulating pumps	Grundfos UPM3 Solar 25-75 130
Sensors	PT 1000
Protection type	IP 40



LK 201 SmartSolar is a compact single-pipe solar pump unit, with an insulated casing of brushed stainless steel. It contains all the necessary components for a safe operation and control of the solar heating system such as safety group, circulating pump, ball valve with integrated check valve and thermometer, flow meter with shut-off, filling and drainage valves as well as the electronic differential temperature controller LK 150 SmartSol Access with three sensors or LK 150 SmartSol Top with four sensors.

LK 150 SmartSol Access has 20 preset hydraulic schedules and LK 150 SmartSol Top has 24 preset hydraulic schedules for different solar heating systems. The chosen hydraulic schedule and operating status is shown on the backlit colour display. Controls and settings are easily carried out using the rotating knob and the esc-button.

For more information about the functions of the solar controller - please see the product sheet for LK 150 SmartSol.

LK 201 SmartSolar is connected to the return pipe of the solar collector. The discharge pipe from the safety valve is run to a heat resistant collection vessel. The electrical installation must be performed by a qualified electrician.

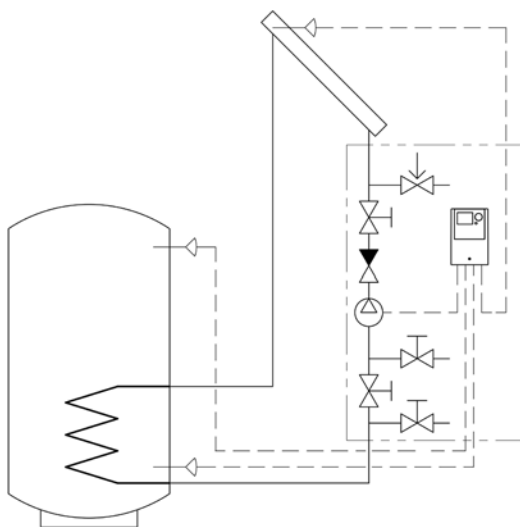

LK 201 SmartSolar - Compression fitting

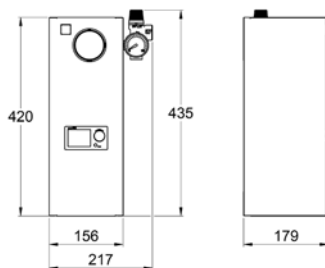

Article no.	Dimension 1	Dimension 2	Flow range	Note	Weight kg
181797	22 mm	M 3/4"	2-12 l/min	SmartSol Access	7.1
181799	22 mm	M 3/4"	2-12 l/min	SmartSol Top	7.1
181099	22 mm	M 3/4"	2-12 l/min.	Without solar controller	6.5
181798	22 mm	G 3/4"	8-28 l/min	SmartSol Access	7.1
181800	22 mm	M 3/4"	8-28 l/min	SmartSol Top	7.1

Dimension 1 = Connection for solar collector pipe

Dimension 2 = Connection for expansion vessel and filling / drainage valve

SPARE PARTS AND ACCESSORIES



Article no.	Article	Position
025041	Differential temperature controller SmartSol Access	1
025042	Differential temperature controller SmartSol Top	1
181187	Collector sensor PT 1000 Ø 5 mm - 3 m cable	2
181186	Tank sensor PT 1000 Ø 6 mm - 4 m cable	3
180812	Sensor pocket 150 mm	4
187170	Circulating pump Grundfos UPM3 Solar 25-75 130	5

LK 202 SmartSolar



TECHNICAL DATA

Voltage	230 VAC \pm 10%, 50 Hz
Working temperature	Min. 0°C/Max. 120°C (150°C briefly)
Max. working pressure	1.0 MPa (10 bar)
Operating pressure	0.6 MPa (6 bar)
Media	Water - Propylene glycol mixture max. 50%
Thread standard	G - male thread
Circulating pumps	Grundfos UPM3 Solar 25-75 130
Sensors	PT 1000
Protection type	IP 40



LK 202 SmartSolar is a compact dual-pipe solar pump unit, with an insulated casing of brushed stainless steel. It contains all the necessary components for a safe operation and control of the solar heating system such as safety group, circulating pump, ball valve with integrated check valve and thermometer, air separator with manual air vent connection, flow meter with shut-off, filling and drainage valves as well as the electronic differential temperature controller LK 150 SmartSol Access with three sensors or LK 150 SmartSol Top with four sensors.

LK 150 SmartSol Access has 20 preset hydraulic schedules and LK 150 SmartSol Top has 24 preset hydraulic schedules for different solar heating systems. The chosen hydraulic schedule and operating status is shown on the backlit colour display. Controls and settings are easily carried out using the rotating knob and the esc-button.

For more information about the functions of the solar controller - please see the product sheet for LK 150 SmartSol.

LK 202 SmartSolar is connected to the supply and return pipes of the solar collector. The discharge pipe from the safety valve is run to a heat resistant collection vessel. The electrical installation must be performed by a qualified electrician.

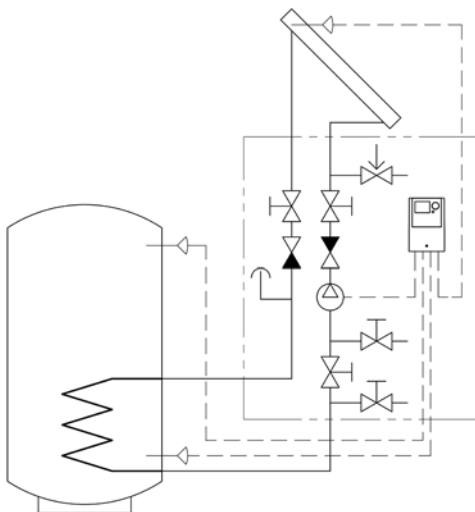

LK 202 SmartSolar - Compression fitting

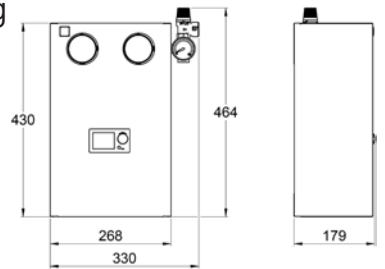

Article no.	Dimension 1	Dimension 2	Flow range	Note	Weight kg
181801	22 mm	M 3/4"	2-12 l/min.	SmartSol Access	9.6
181803	22 mm	M 3/4"	2-12 l/min.	SmartSol Top	9.6
181100	22 mm	M 3/4"	2-12 l/min.	Without solar controller	9.0
181802	22 mm	M 3/4"	8-28 l/min.	SmartSol Access	9,6
181804	22 mm	M 3/4"	8-28 l/min.	SmartSol Top	9,6

Dimension 1 = Connection for solar collector pipe and storage tank

Dimension 2 = Connection for expansion vessel and filling / drainage valve

SPARE PARTS AND ACCESSORIES



Article no.	Article	Position
025041	Differential temperature controller SmartSol Access	1
025042	Differential temperature controller SmartSol Top	1
181187	Collector sensor PT 1000 Ø 5 mm - 3 m cable	2
181186	Tank sensor PT 1000 Ø 6 mm - 4 m cable	3
180812	Sensor pocket 150 mm	4
187170	Circulating pump Grundfos UPM3 Solar 25-75 130	5

SmartSol/SmartSolar

- For a safe operation and control of your solar heating system!



20 or 24 preset hydraulic systems

Hydraulic systems for swimmingpool applications

Handles high-efficiency pumps

LK 150 SmartSol

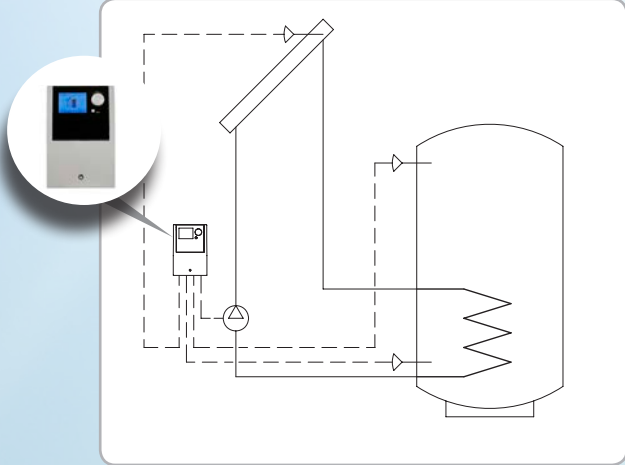

Electronic differential temperature controller for solar heating systems.

LK 201 SmartSolar

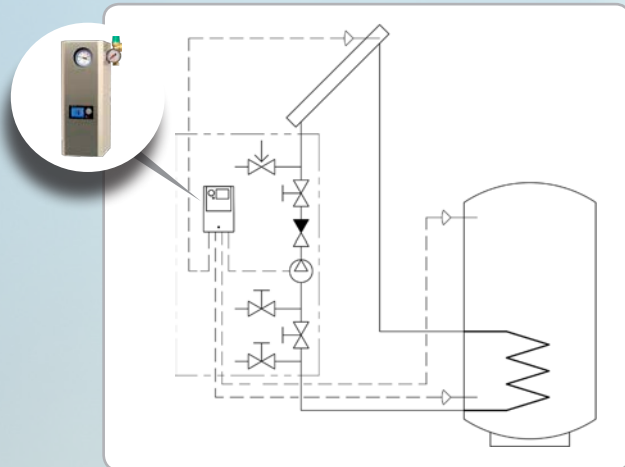

Compact single-pipe solar pump unit, with an insulated casing of brushed stainless steel. It contains all the necessary components for a safe operation and control of the solar heating system.

LK 202 SmartSolar

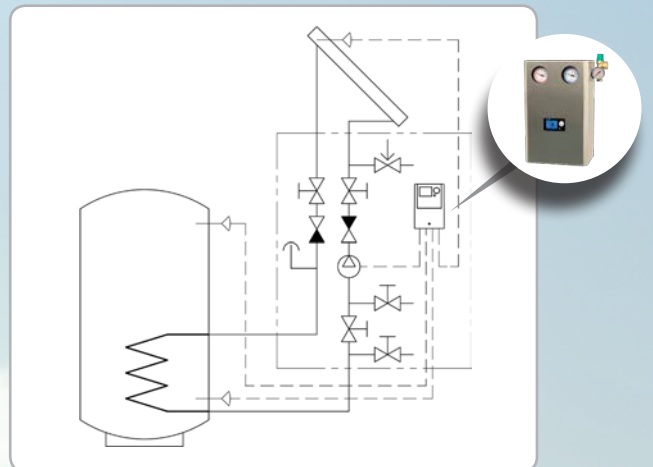

Compact dual-pipe solar pump unit, with an insulated casing of brushed stainless steel. It contains all the necessary components for a safe operation and control of the solar heating system.

Zone Valves



LK 525 MultiZone 2W
2-way zone valve for On/Off control.



LK 525 MultiZone 3W
3-way zone valve for On/Off control.



LK 525 MultiZone Polar
3-way zone valve for On/Off control.



LK 525 MultiZone Solar
3-way zone valve for On/Off control.



LK 525 MultiZone 3R
3-way valve that can be used as a mixing valve or as a diverting valve in heating systems.



LK 527 MultiZone 2W
2-way ball valve with high flow capacity.



LK 527 MultiZone 3W
3-way ball valve.

LK 525 MultiZone 2W



TECHNICAL DATA

Working temperature	Min. 5 °C/Max. 80 °C (90 °C briefly)
Ambient temp.	Min. 1 °C/Max. 60 °C
Max. working pressure	1.0 MPa (10 bar)
Max. differential pressure	100 kPa (1 bar)
Leakage	< 0.1% of Kvs at 100 kPa
Angle of rotation	90°/360°
Media	Water - Glycol/Ethanol mixture max. 50%
Thread standard	G - male thread
Actuator	7 VA, 230 VAC, 50 Hz
Operation time	12 seconds (90°)
Electrical connection	Fixed wire
Signal connector	Single pole SPST
Protection class	IP 44
Material, valve body	Brass EN 12165 CW617N
Material, external cover	Brass EN 12164 CW614N
Material, slide/spindle	PPS Composite
Cable specification	Dimension 3 x 0,75 mm ²
Wire colours	Blue, brown, black
External insulation	PVC

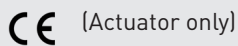

LK 525 MultiZone is a motorized 2-way zone valve for application in heating systems in which the flow through one or more zones is to be controlled. The zone valve has On/Off control and is designed with a turning slide which allows it to withstand a larger pressure difference and reduces the risk of it stalling after a long intermission. On the upper surface of the actuator is an indicator that shows which port is open or closed.

The zone valve must not be installed with the motor underneath the valve unit.

In case of a power failure, the valve cone stays in its current position. When the power is switched off, the valve can be manually set. Remove the motor and turn the spindle to your selected position. When the power is restored, turn the valve back to its original position and reinstall the motor.

Please note that the motor can be installed in only one position.

CAPACITY DIAGRAM

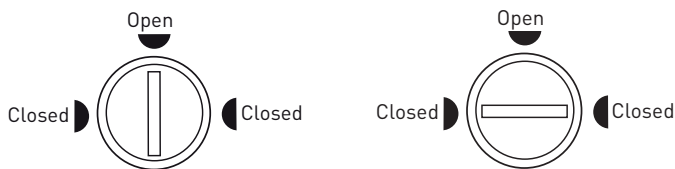
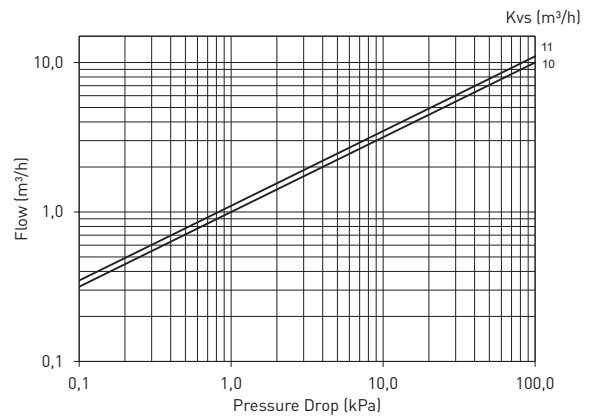

WIRING DIAGRAM

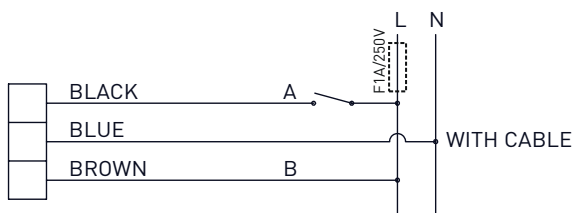

Valve and motor are available in closed or open position (NC; Normally Closed or NO; Normally Open)

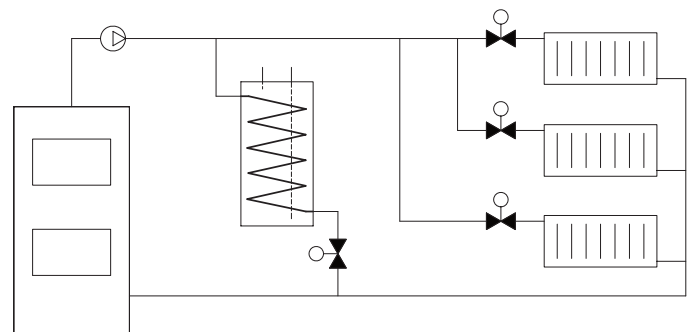

LK 525 2W - Male thread

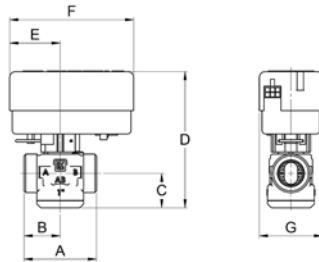

Article no.	Connection	Type	Kvs m ³ /h	A mm	B mm	C mm	D mm	E mm	F mm	G mm	Weight kg
066112	M 3/4"	NC	10	70	35	30	118	43	107	54	0.2
066102	M 1"	NC	11	62	31	30	118	43	107	54	0.3
066103	M 1 1/4"	NC	11	74	37	30	118	43	107	54	0.6
066115	M 3/4"	NO	10	70	35	30	118	43	107	54	0.2
066113	G 1"	NO	11	62	31	30	118	43	107	54	0.3
066114	M 1 1/4"	NO	11	74	37	30	118	43	107	54	0.6
066111	EMV 110-K SPST Actuator 230 VAC, Cable 1000 mm	NC									0.3
066199	EMV 110-K SPST Actuator 230 VAC, Cable 1000 mm	NO									0.3

LK 525 2W - Compression fitting

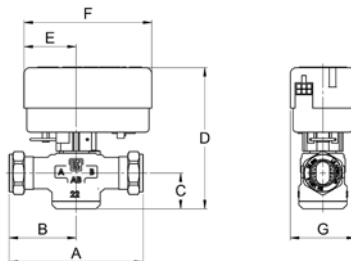

Article no.	Connection	Type	Kvs m ³ /h	A mm	B mm	C mm	D mm	E mm	F mm	G mm	Weight kg
066104	22 mm	NC	11	110	55	30	118	43	107	54	0.4
066105	28 mm	NC	11	110	55	30	118	43	107	54	0.6
066116	22 mm	NO	11	110	55	30	118	43	107	54	0.4
066119	28 mm	NO	11	110	55	30	118	43	107	54	0.6
066111	EMV 110-K SPST Actuator 230 VAC, Cable 1000 mm	NC									0.3
066199	EMV 110-K SPST Actuator 230 VAC, Cable 1000 mm	NO									0.3

LK 525 MultiZone 3W



TECHNICAL DATA

Working temperature	Min. 5 °C/Max. 80 °C (90 °C briefly)
Art.no. 066399:	Min. 5 °C/Max. 70 °C (80 °C briefly)
Ambient temp.	Min. 1 °C/Max. 60 °C
Max. working pressure	1.0 MPa (10 bar)
Max. differential pressure	100 kPa (1 bar)
Leakage	< 0.1% of Kvs at 100 kPa
Angle of rotation	60°/360°
Media	Water - Glycol/Ethanol mixture max. 50%
Thread standard	G - male thread
Actuator	7 VA, 230 VAC, 50 Hz 7 VA, 24 VAC, 50 Hz
Operation time	8 seconds (60°)
Electrical connection	Fixed wire alternatively Molex®-compatible connector
Signal connector	Single pole SPST
Protection class	IP 40 (Molex®) / IP 44 (Kabel)
Material, valve body	Brass EN 12165 CW617N
Material, external cover	Brass EN 12164 CW614N
Material, slide/spindle	PPS Composite
Cable specification	Dimension 3 x 0.75 mm ²
Wire colours	Blue, brown, black
External insulation	PVC
Connection	Molex® or Molex®-compatible connector, 6-circuit

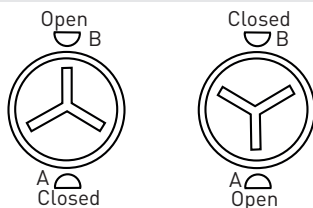
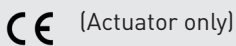

CAPACITY DIAGRAM

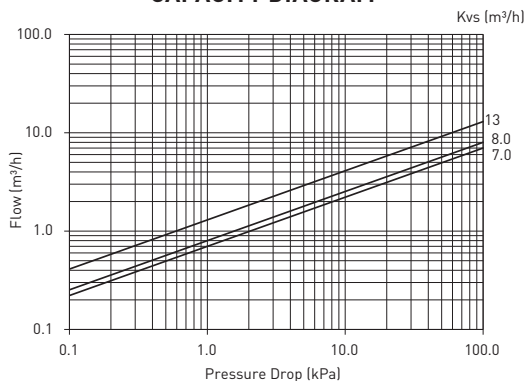

LK 525 MultiZone 3W is a motorized 3-way zone valve for On/Off control. The zone valve is designed with a turning slide which allows it to withstand a larger pressure difference and reduces the risk of it stalling after a long intermission. This makes it especially suited for heat pump applications where there can be long intermissions between the changes to the direction of the flow during the warm season. On the upper surface of the actuator is an indicator that shows which port is open.

The zone valve must not be installed with the motor underneath the valve unit.

In case of a power failure, the valve cone stays in its current position.

When the power is switched off, the valve can be manually set to the centre position, which distributes the flow between the heating and tap water circuits. Remove the motor and turn the spindle about 30° or turn until hot water flows through both valve ports. When the power is restored, turn the valve back to its original position and reinstall the motor.

Please note that the motor can be installed in only one position.

WIRING DIAGRAM

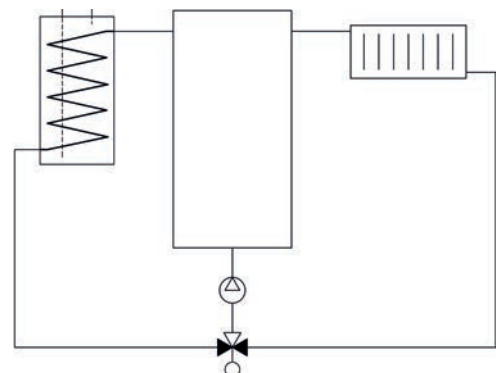
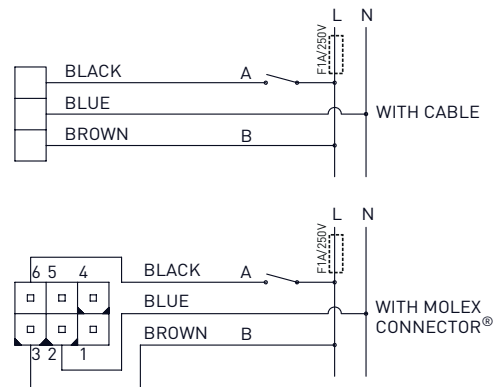

LK 525 3W - Male thread

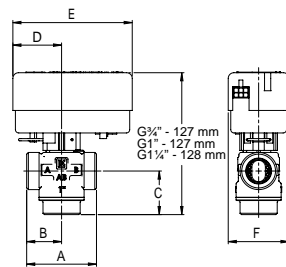

Article no.	Connection	Kvs m ³ /h	A mm	B mm	C mm	D mm	E mm	F mm	Weight kg
066000	M 3/4"	7.0	70	35	39	43	107	54	0.3
066106	M 1"	8.0	62	31	39	43	107	54	0.3
066107	M 1 1/4"	8.0	74	37	40	43	107	54	0.6
066060	EMV 110-M SPST Actuator 230 VAC with Molex®								0.3
066061	EMV 110-K SPST Actuator 230 VAC with cable 1000 mm								0.3
066062	EMV 110-K SPST Actuator 230 VAC with cable 3000 mm								0.4
066063	EMV 110-M SPST Actuator 24 VAC with Molex®								0.3
066083	Cable-M 3x0.75 L=1000 mm with Molex®								0.1

LK 525 3W - Compression fitting

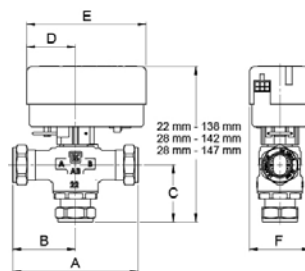

Article no.	Connection	Kvs m ³ /h	A mm	B mm	C mm	D mm	E mm	F mm	Weight kg
066108	22 mm	8.0	110	55	50	43	107	54	0.4
066109	28 mm	8.0	110	55	54	43	107	54	0.6
066399	28 mm	13	114	57	59	43	107	54	0.8
066060	EMV 110-M SPST Actuator 230 VAC with Molex®								0.3
066061	EMV 110-K SPST Actuator 230 VAC with cable 1000 mm								0.3
066062	EMV 110-K SPST Actuator 230 VAC with cable 3000 mm								0.4
066063	EMV 110-M SPST Actuator 24 VAC with Molex®								0.3
066083	Cable-M 3x0.75 L=1000 mm with Molex®								0.1

SPARE PARTS AND ACCESSORIES



Article no.	Article	Position
187202	Insulation	1

LK 525 MultiZone Polar



TECHNICAL DATA

Working temperature	Min. -15 °C/Max. 80 °C (90 °C briefly)
Ambient temp.	Min. 1 °C/Max. 60 °C
Max. working pressure	1.0 MPa (10 bar)
Max. differential pressure	100 kPa (1 bar)
Leakage	< 0.1% of Kvs at 100 kPa
Angle of rotation	60°/360°
Media	Water - Glycol/Ethanol mixture max. 50%
Thread standard	G - male thread
Actuator	7 VA, 230 VAC, 50 Hz 7 VA, 24 VAC, 50 Hz
Operation time	8 seconds (60°)
Electrical connection	Fixed wire alternatively Molex®- compatible connector
Signal connector	Single pole SPST
Protection class	IP 40 (Molex®) / IP 44 (Kabel)
Material, valve body	Brass EN 12165 CW617N
Material, external cover	Brass EN 12164 CW614N
Material, slide/spindle	PPS Composite
Cable specification	Dimension 3 x 0.75 mm ²
Wire colours	Blue, brown, black
External insulation	PVC
Connection	Molex® or Molex®-compatible connector, 6-circuit

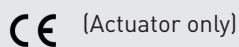

LK 525 MultiZone Polar is a motorized 3-way zone valve for On/Off control intended for use in cooling systems where the temperature of the media can go below 0 °C. The plastic adapter is installed between the valve unit and the actuator to protect the actuator against condensation and icing. The zone valve is designed with a turning slide which allows it to withstand a larger pressure difference and reduces the risk of it stalling after longer periods of intermission. On the upper surface of the actuator is an indicator that shows which port is open.

The zone valve must not be installed with the motor underneath the valve unit. The valve needs to be insulated.

In case of a power failure, the valve cone stays in its current position. When the power is switched off, the valve can be manually set to the centre position, which distributes the flow between the circuits. Remove the motor and turn the spindle about 30° or turn until fluid flows through both valve ports. When the power is restored, turn the valve back to its original position and reinstall the motor.

Please note that the motor can be installed in only one position.

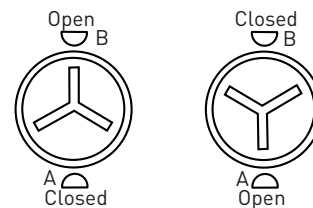

CAPACITY DIAGRAM

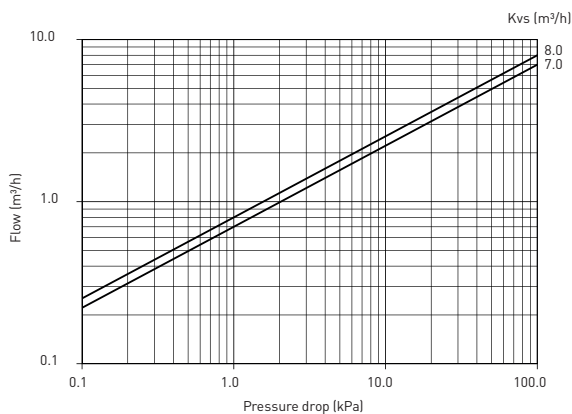

WIRING DIAGRAM

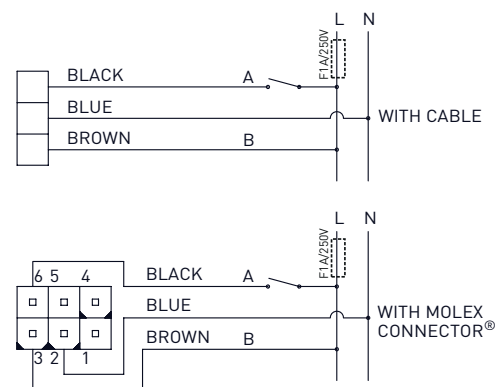

LK 525 Polar - Male thread

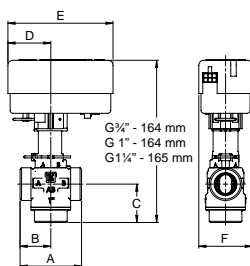

Article no.	Connection	Kvs m ³ /h	A mm	B mm	C mm	D mm	E mm	F mm	Weight kg
066000	M 3/4"	7.0	70	35	39	43	107	54	0.3
066106	M 1"	8.0	62	31	39	43	107	54	0.3
066107	M 1 1/4"	8.0	74	37	40	43	107	54	0.6
066177	Adapter								
066060	EMV 110-M SPST Actuator 230 VAC with Molex®								0.3
066061	EMV 110-K SPST Actuator 230 VAC with cable 1000 mm								0.3
066062	EMV 110-K SPST Actuator 230 VAC with cable 3000 mm								0.4
066063	EMV 110-M SPST Actuator 24 VAC with Molex®								0.3
066083	Cable-M 3x0.75 L=1000 mm with Molex®								0.1

LK 525 Polar - Compression fitting

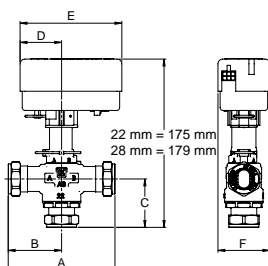

Article no.	Connection	Kvs m ³ /h	A mm	B mm	C mm	D mm	E mm	F mm	Weight kg
066108	22 mm	8.0	110	55	50	43	107	54	0.4
066109	28 mm	8.0	110	55	54	43	107	54	0.6
066177	Adapter								
066060	EMV 110-M SPST Actuator 230 VAC with Molex®								0.3
066061	EMV 110-K SPST Actuator 230 VAC with cable 1000 mm								0.3
066062	EMV 110-K SPST Actuator 230 VAC with cable 3000 mm								0.4
066063	EMV 110-M SPST Actuator 24 VAC with Molex®								0.3
066083	Cable-M 3x0.75 L=1000 mm with Molex®								0.1

SPARE PARTS AND ACCESSORIES



Article no.	Article	Position
187202	Insulation	1

LK 525 MultiZone Solar



TECHNICAL DATA

Working temperature	Min. -15 °C/Max. 120 °C (160 °C briefly)
Ambient temp.	Min. 1 °C/Max. 60 °C
Max. working pressure	1.0 MPa (10 bar)
Max. differential pressure	100 kPa (1 bar)
Leakage	< 0.1% of Kvs at 100 kPa
Angle of rotation	60°/360°
Media	Water - Glycol/Ethanol mixture max. 50%
Thread standard	G - male thread
Actuator	7 VA, 230 VAC, 50 Hz 7 VA, 24 VAC, 50 Hz
Operation time	8 seconds (60°)
Electrical connection	Fixed wire alternatively Molex®-compatible connector
Signal connector	Single pole SPST
Protection class	IP 40 (Molex®) / IP 44 (Kabel)
Material, valve body	Brass EN 12165 CW617N
Material, external cover	Brass EN 12164 CW614N
Material, slide/spindle	PPS Composite
Cable specification	Dimension 3 x 0.75 mm ²
Wire colours	Blue, brown, black
External insulation	PVC
Connection	Molex® or Molex®-compatible connector, 6-circuit

CE (Actuator only)

LK 525 MultiZone Solar is a motorized 3-way zone valve for On/Off control intended for use in solar heating systems where the temperature of the media can reach very high levels. The plastic adapter is installed between the valve unit and the actuator to protect the actuator against high temperatures. The zone valve is designed with a turning slide which allows it to withstand a larger pressure difference and reduces the risk of it stalling after longer periods of intermission. On the upper surface of the actuator is an indicator that shows which port is open.

The zone valve must not be installed with the motor underneath the valve unit.

In case of a power failure, the valve cone stays in its current position. When the power is switched off, the valve can be manually set to the centre position, which distributes the flow between the circuits. Remove the motor and turn the spindle about 30° or turn until fluid flows through both valve ports. When the power is restored, turn the valve back to its original position and reinstall the motor.

Please note that the motor can be installed in only one position.

WIRING DIAGRAM

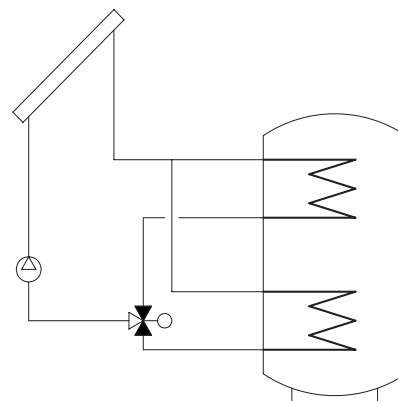
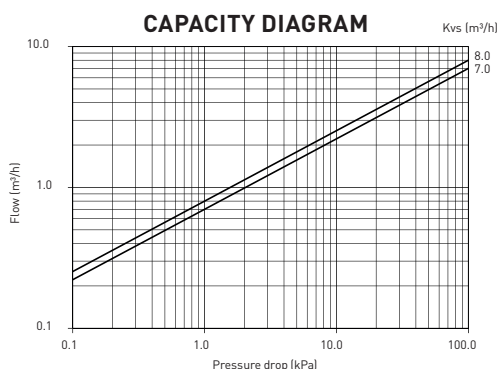
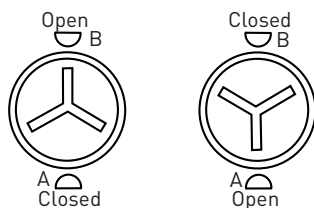
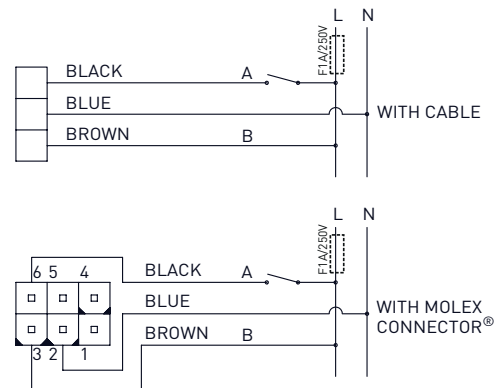

LK 525 Solar- Male thread

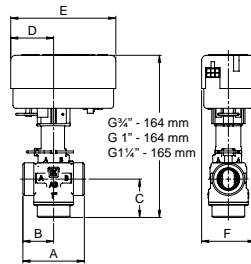

Article no.	Connection	Kvs m ³ /h	A mm	B mm	C mm	D mm	E mm	F mm	Weight kg
066000	M 3/4"	7.0	70	35	39	43	107	54	0.3
066106	M 1"	8.0	62	31	39	43	107	54	0.3
066107	M 1 1/4"	8.0	74	37	40	43	107	54	0.6
066177	Adapter								
066060	EMV 110-M SPST Actuator 230 VAC with Molex®								0.3
066061	EMV 110-K SPST Actuator 230 VAC with cable 1000 mm								0.3
066062	EMV 110-K SPST Actuator 230 VAC with cable 3000 mm								0.4
066063	EMV 110-M SPST Actuator 24 VAC with Molex®								0.3
066083	Cable-M 3x0.75 L=1000 mm with Molex®								0.1

LK 525 Solar - Compression fitting

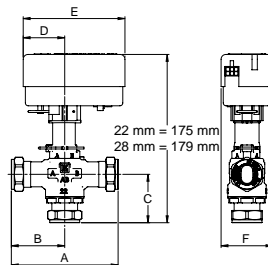

Article no.	Connection	Kvs m ³ /h	A mm	B mm	C mm	D mm	E mm	F mm	Weight kg
066108	22 mm	8.0	110	55	50	43	107	54	0.4
066109	28 mm	8.0	110	55	54	43	107	54	0.6
066177	Adapter								
066060	EMV 110-M SPST Actuator 230 VAC with Molex®								0.3
066061	EMV 110-K SPST Actuator 230 VAC with cable 1000 mm								0.3
066062	EMV 110-K SPST Actuator 230 VAC with cable 3000 mm								0.4
066063	EMV 110-M SPST Actuator 24 VAC with Molex®								0.3
066083	Cable-M 3x0.75 L=1000 mm with Molex®								0.1

SPARE PARTS AND ACCESSORIES



Article no.	Article	Position
187202	Insulation	1

LK 525 MultiZone 3R



TECHNICAL DATA

Voltage	230 VAC, 50 Hz
Power consumption	5 VA
Working temperature	Min. 5 °C/Max. 80 °C (90 °C briefly)
Ambient temp.	Min. 5 °C/Max. 55 °C
Max. working pressure	1.0 MPa (10 bar)
Max. differential pressure	100 kPa (1 bar)
Leakage	< 0.1% of Kvs at 100 kPa
Angle of rotation	90°
Torque	5 Nm
Media	Water - Glycol/Ethanol mixture max. 50%
Operation time	110 s
Manual override	Yes
Electrical connection	Fixed wire
Signal connector	3 point SPDT
Protection type	IP 44
Protection class	II
Material, valve body	Brass EN 12165 CW617N
Material, external cover	Brass EN 12164 CW614N
Material, slide/spindle	PPS Composite
Cable specification	3 x 0.75 mm ²
Wire colours	Blue, brown, black
External insulation	PVC



LK 525 MultiZone 3R is a 3-way valve that can be used as a mixing valve or as a diverting valve in heating systems.

The valve is constructed so that the leakage is less than 0.1% of Kvs at 100 kPa. It also has a split linear characteristic which means that the regulation is good even at low flows and capacities.

The valve must not be installed with the motor underneath the valve unit.

Please note that the motor can be installed in only one position.

The motor operates anti clockwise when the black conductor is powered and clockwise when the brown conductor is powered.

WIRING DIAGRAM

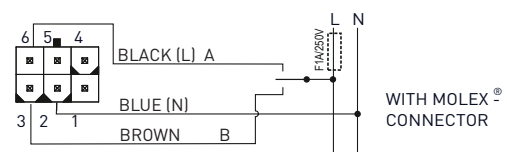
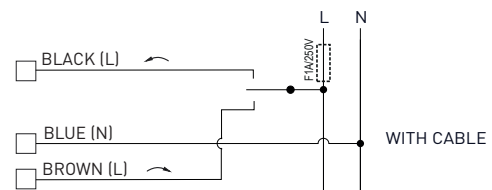

VALVE CHARACTERISTICS

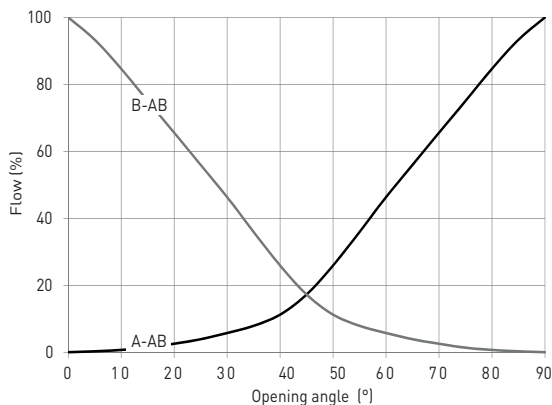

CAPACITY DIAGRAM

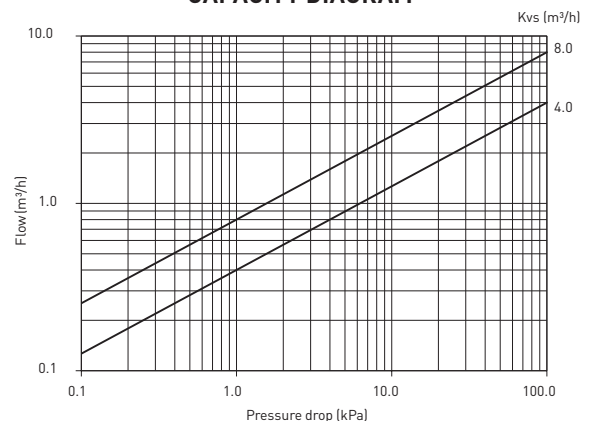

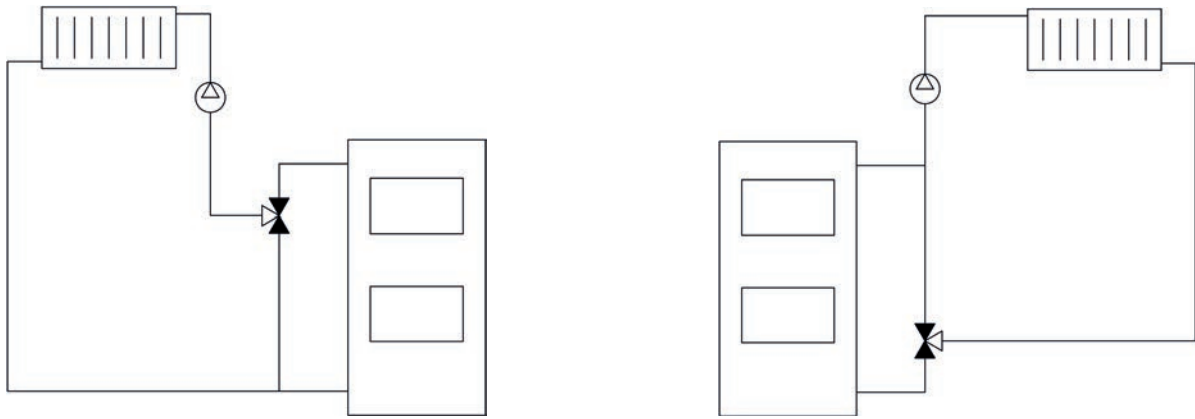

LK 525 3R - Male thread

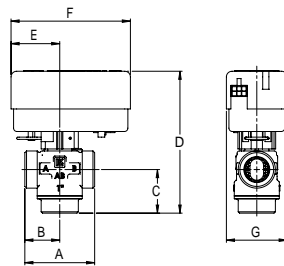

Article no.	Connection	Kvs m ³ /h	Voltage	Torque	Operation time	A mm	B mm	C mm	D mm	E mm	F mm	G mm	Weight kg
066350	M 3/4"	4,0				70	35	39	132	46	109	58	0.3
066351	M 1"	4,0				62	31	39	132	46	109	58	0.3
066352	M 1 1/4"	4,0				74	37	40	133	46	109	58	0.6
066076	M 3/4"	8,0				70	35	39	132	46	109	58	0.3
066077	M 1"	8,0				62	31	39	132	46	109	58	0.3
066078	M 1 1/4"	8,0				74	37	40	133	46	109	58	0.6
066127	1 m cable		230 V	5 Nm	110 s	109	58	45	73	85			0.4
066128	1 m cable 0-10 VDC		24 VAC	5 Nm	110 s	109	58	45	73	85			0.4

Other operation times on request.

LK 525 3R - Compression fitting

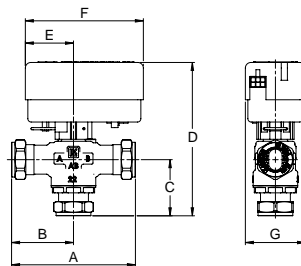

Article no.	Connection	Kvs m ³ /h	Voltage	Torque	Operation time	A mm	B mm	C mm	D mm	E mm	F mm	G mm	Weight kg
066353	22 mm	4,0				110	55	50	143	46	109	58	0.4
066354	28 mm	4,0				110	55	54	147	46	109	58	0.6
066079	22 mm	8,0				110	55	50	143	46	109	58	0.4
066080	28 mm	8,0				110	55	54	147	46	109	58	0.6
066127	1 m cable		230 V	5 Nm	110 s	109	58	45	73	85			0.4
066128	1 m cable 0-10 VDC		24 VAC	5 Nm	110 s	109	58	45	73	85			0.4

Other operation times on request.

SPARE PARTS AND ACCESSORIES



Article no.	Article	Position
187202	Insulation	1

LK 527 MultiZone 2W



TECHNICAL DATA

Working temperature	Min. 2 °C/Max. 110 °C
Ambient temp.	Min. 1 °C/Max. 55 °C
Max. working pressure	3,2 MPa (32 bar)
Max. differential pressure	600 kPa (6 bar)
Media	Water - Glycol mixture max. 50%
Thread standard	R - male thread, Rp - female thread, G - male thread
Actuator	230 VAC, 50 Hz
Electrical connection	Fixed wire
Signal connector	2-Point SPST
Protection class	IP 44
Material, valve body	Brass EN 12165 CW617N
Material, ball	Brass CW617N
Cable specification	Dimension 3 x 0,75 mm ²
Wire colours	Blue, brown, black
External insulation	PVC
Type approval certificate	Actuator: CE Valve: DIN-DVGW*, WRAS*, ACS

CE (Actuator only)

*Applies for 527 MultiZone 2W female thread

LK 527 MultiZone is a motorized 2-way ball valve with high flow capacity for applications in, for example heating, cooling and domestic water systems.

The zone valve has On/Off control and is controlled by 2-point signal.

Assembly/disassembly of actuator on the ball valve is simple and secure, using the clip-system.

The zone valve must not be installed with the actuator underneath the valve unit.

In case of a power failure, the valve stays in its current position. When the power is switched off, the valve can be manually set by the handle on the actuator.

Please note that the actuator can be installed in only one position.

WIRING DIAGRAM

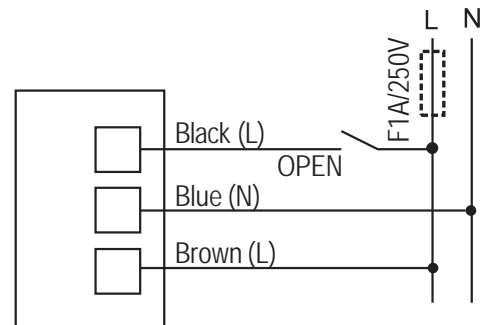

CAPACITY DIAGRAM

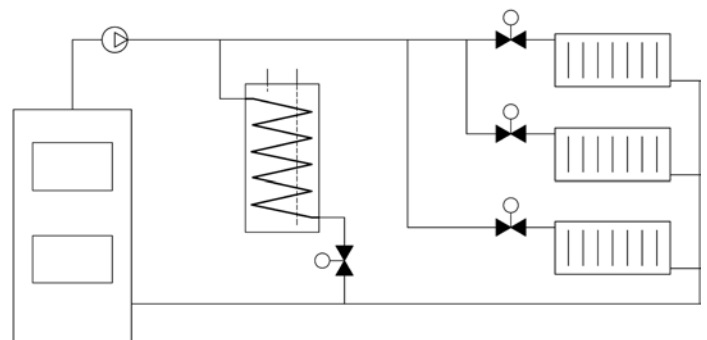
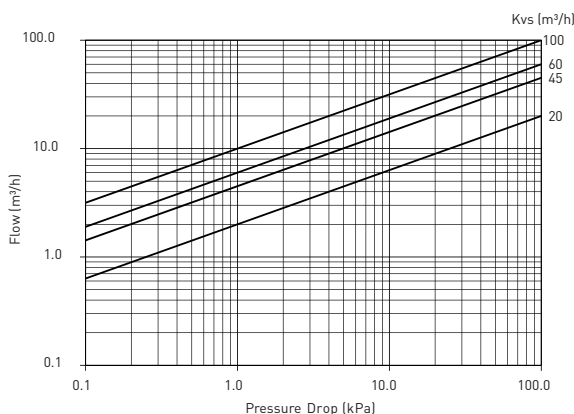

LK 527 2W - Female Thread

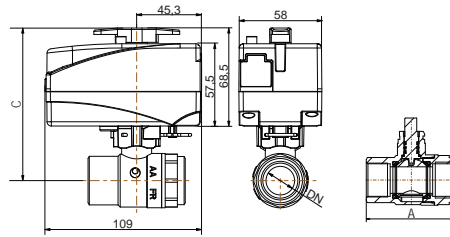

Article no.	Dimension	Kvs m ³ /h	A mm	C mm	Weight kg
066263	F 1/2"	20	62	104	0.6
066264	F 3/4"	45	68	107	0.7
066265	F 1"	60	81	112	0.9
066266	F 1 1/4"	100	86	117	1.1

LK 527 2W - Male thread / Female thread

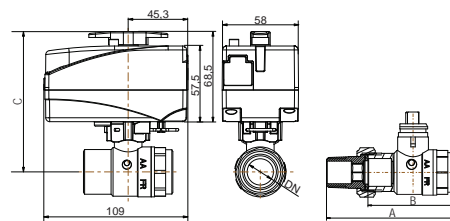

Article no.	Dimension	Kvs m ³ /h	A mm	B mm	C mm	Weight kg
066267	F 1/2" with one transition fitting M 1/2"	20	90	62	104	0.7
066268	F 3/4" with one transition fitting M 3/4"	45	102	70	107	0.8
066269	F 1" with one transition fitting M 1"	60	114	81	112	1.1
066270	F 1 1/4" with one transition fitting M 1 1/4"	100	117	79	117	1.3

LK 527 2W - Male thread

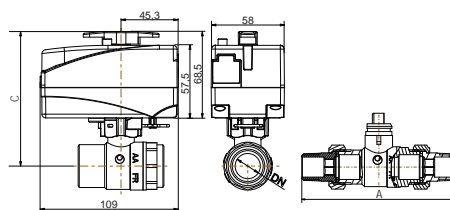

Article no.	Dimension	Kvs m ³ /h	A mm	C mm	Weight kg
066271	M 3/4" with transition fitting M 1/2"	20	119	104	0.7
066272	M 1" with transition fitting M 3/4"	45	138	107	0.9
066273	M 1 1/4" with transition fitting M 1"	60	149	112	1.2
066274	M 1 1/2" with transition fitting M 1 1/4"	100	158	117	1.5

LK 527 2W - Compression fitting

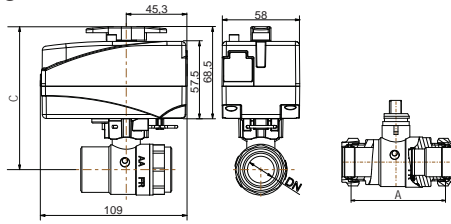

Article no.	Dimension	Kvs m ³ /h	A mm	C mm	Weight kg
066275	15 mm	20	62	104	0.6
066276	22 mm	45	72	107	0.7
066277	28 mm	60	82	112	1.0

LK 527 2W - Male thread

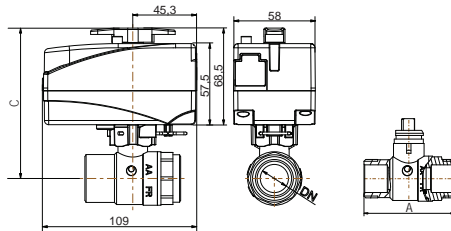

Article no.	Dimension	Kvs m ³ /h	A mm	C mm	Weight kg
066278	M ¾"	20	62	104	0.6
066279	M 1"	45	74	107	0.8
066280	M 1¼"	60	82	112	1.0
066281	M 1½"	100	83	117	1.1

LK 527 2W- Male Thread

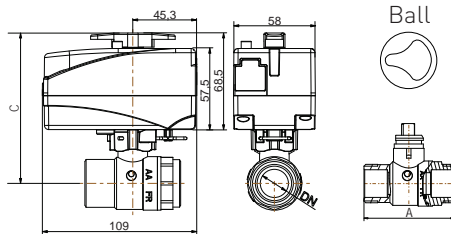

Article no.	Dimension	Kvs m ³ /h	A mm	C mm	Weight kg
066288	M ¾"	20	62	104	0.6
066289	M 1"	45	74	107	0.8
066290	M 1¼"	60	82	112	1.0

LK 527 - Actuator

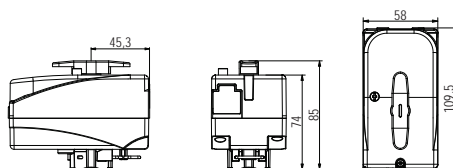

Article no.	Connection	Voltage	Torque	Operation time	Weight kg
066282	2-point SPST output, with cable 1000 mm	230 V	5 Nm	12s* / 90°	0.4
066283	2-point SPST output, with cable 1000 mm	230 V	5 Nm	30s / 90°	0.4

*Only for valve units up to 1"

LK 527 MultiZone 3W



TECHNICAL DATA

Working temperature	Min. 2 °C/Max. 110 °C
Ambient temp.	Min. 1 °C/Max. 55 °C
Max. working pressure	3.2 MPa (32 bar)
Max. differential pressure	600 kPa (6 bar)
Media	Water - Glycol mixture max. 50%
Thread standard	R - male thread, Rp - female thread, G - male thread
Actuator	230 VAC, 50 Hz
Electrical connection	Fixed wire
Signal connector	3-Point SPDT
Protection class	IP 44
Material, valve body	Brass CW617N
Material, ball	Brass CW617N
Cable specification	Dimension 3 x 0.75 mm ²
Wire colours	Blue, brown, black
External insulation	PVC
Type approval certificate	Actuator: CE Valve: ACS

CE (Actuator only)

LK 527 MultiZone is a motorized 3-way ball valve for applications in, for example heating, cooling and domestic water systems.

The zone valve is controlled by 3-point signal.

Assembly/disassembly of actuator on the ball valve is simple and secure, using the clip-system.

The zone valve must not be installed with the actuator underneath the valve unit.

In case of a power failure, the valve stays in its current position. When the power is switched off, the valve can be manually set by the handle on the actuator.

Please note that the actuator can be installed in only one position.

WIRING DIAGRAM

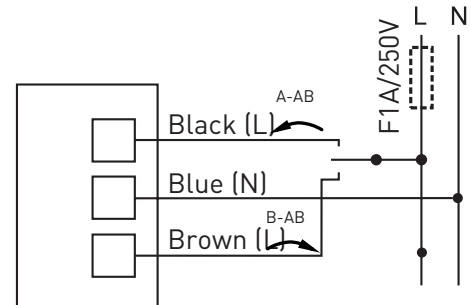

CAPACITY DIAGRAM

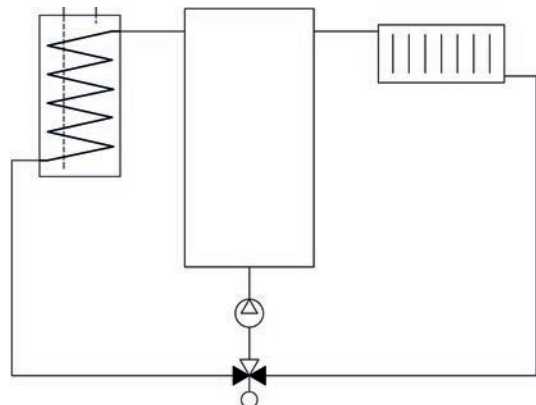
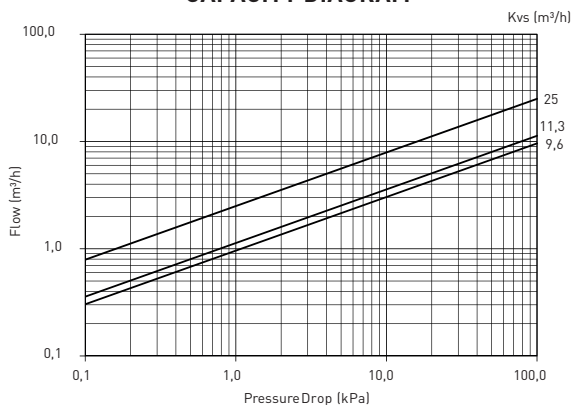

LK 527 3W - Female Thread

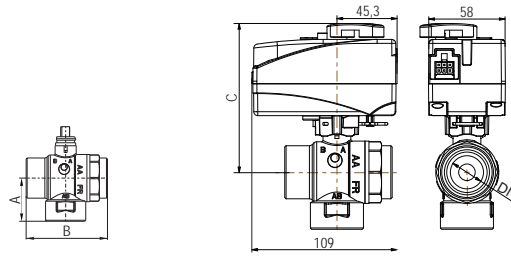

Article no.	Dimension	Kvs m ³ /h	A mm	B mm	C mm	Weight kg
066252	F ¾"	9.6	40	68	104	0.8
066253	F 1"	11.3	43	81	107	1.0
066254	F 1¼"	25	52	86	114	1.2

LK 527 3W - Male Thread

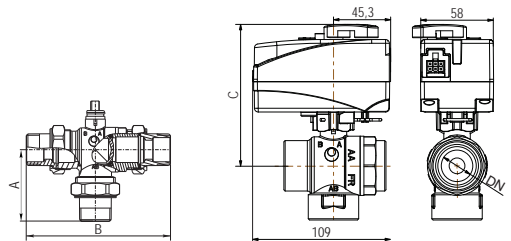

Article no.	Dimension	Kvs m ³ /h	A mm	B mm	C mm	Weight kg
066255	M 1" with transition fitting M ¾"	9.6	72	136	104	1.1
066256	M 1¼" with transition fitting M 1"	11.3	76	152	107	1.5
066257	M 1½" with transition fitting M 1¼"	25	89	165	134	2.1

LK 527 3W - Male thread

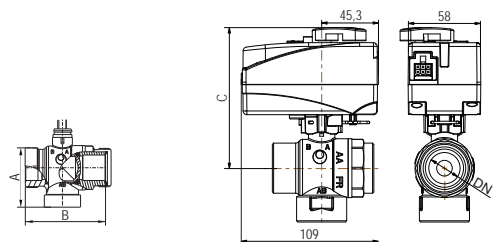

Article no.	Dimension	Kvs m ³ /h	A mm	B mm	C mm	Weight kg
066258	M 1"	9.6	40	72	104	0.8
066259	M 1¼"	11.3	43	85	107	1.0
066260	M 1½"	25	52	90	134	1.3

LK 527 3W - Compression fitting

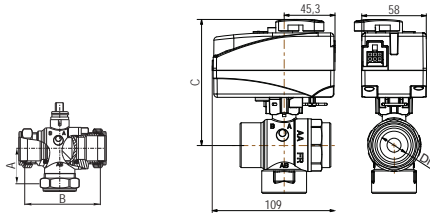

Article no.	Dimension	Kvs m ³ /h	A mm	B mm	C mm	Weight kg
066261	22 mm	9.6	41	72	107	0.8

LK 527 - Actuator

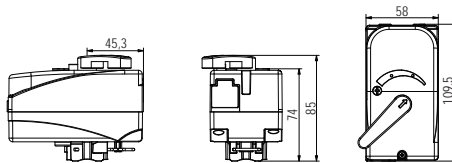

Article no.	Connection	Voltage	Torque	Operation time	Weight kg
066284	3-point SPDT output, with cable 1000 mm	230 V	5 Nm	20s / 90°	0.4
066285	3-point SPDT output, with cable 1000 mm	230 V	5 Nm	40s / 90°	0.4
066286	3-point SPDT output, with cable 1000 mm	230 V	5 Nm	80s / 90°	0.4
066287	3-point SPDT output, with cable 1000 mm	230 V	5 Nm	110s / 90°	0.4

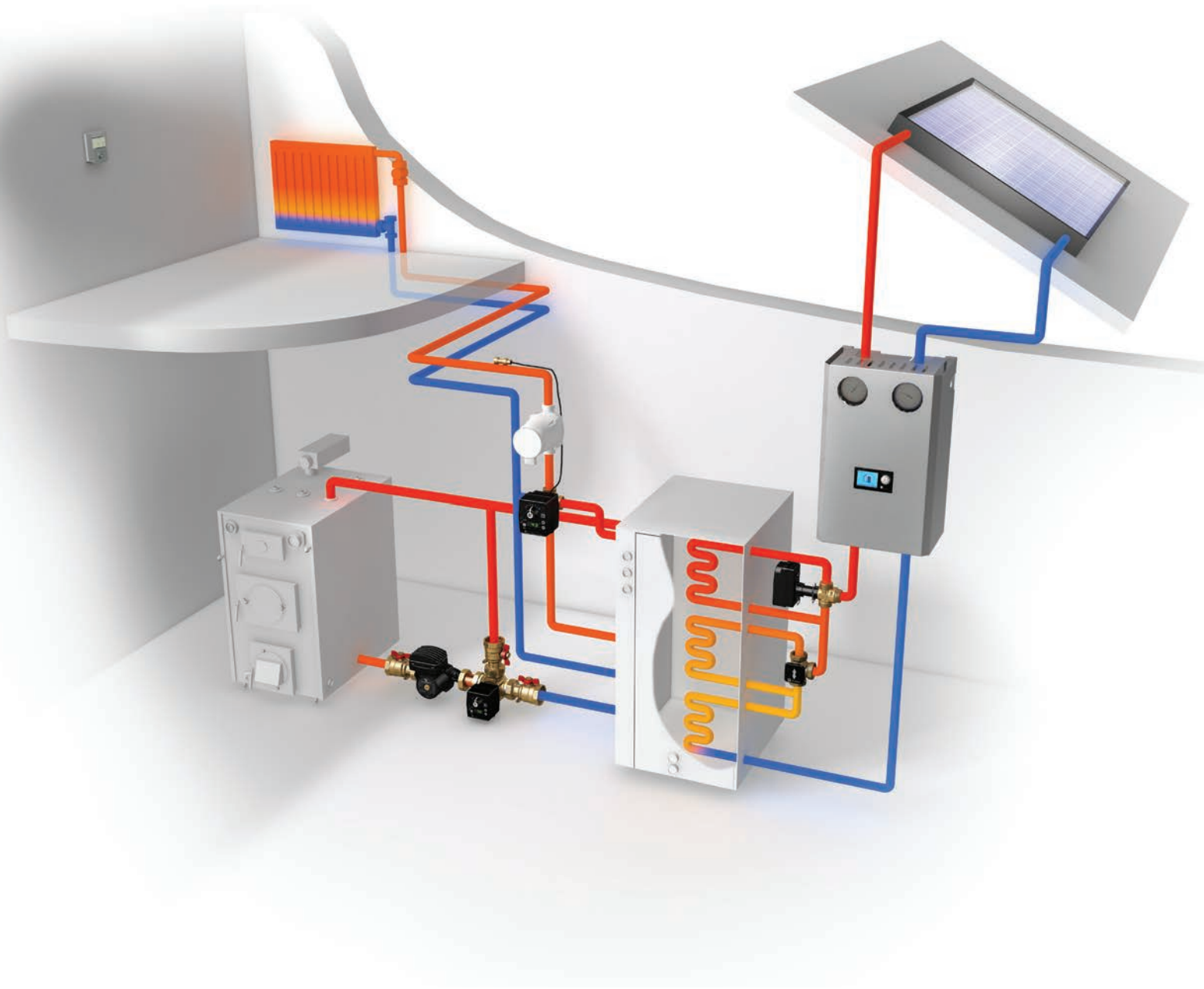

Filling Valves

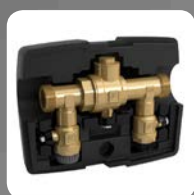

LK 521 MultiFill®

Combination valve for filling refrigerant fluid into ground source heat systems.



LK 538 ThermoFill® EA

Filling valve for heating systems.



LK 539 ThermoFill® EA

Filling valve for heating systems.



LK 521 MultiFill®



TECHNICAL DATA

Working temperature	Min. -20 °C/Max. 80 °C
Max. working pressure	1.0 MPa (10 bar)
Media 1 (DN25, DN32) (DN50)	Water - Glycol mixture max. 50% Water - Glycol mixture max. 30%
Media 2	Water - Ethanol mixture max. 30% (Working temperature: Max. +60 °C)
Thread standard	G - male thread
Material, valve body	Brass EN 12165 CW617N
Material, insulation	Expanded Polystyrene EPS (DN25, DN32)
Mesh opening, filter	
Main valve	DN25, DN32: 0,6 mm ² DN50: 0,8 mm ²
Fillingvalve	DN25, DN32: 0,7 mm ² > DN50: 0,8 mm ²
Material, filter element	
Main valve:	Plastic, Stainless steel
Filling valve.	Stainless steel
Material, sealing	EPDM

LK 521 MultiFill® is a combination valve for easy filling of refrigerant fluid into ground source heat systems. The valve has a filter to protect the evaporator against possible grit. Its compact construction allows it to be installed in tight spaces. The valve comes with an insulation to protect against condensation and possible icing. LK 521 MultiFill® can also be used in other applications where filling and filtration are required.

Arrows on the valve body indicate the direction of the flow. The enclosed insulation should be used.

Apart from cleaning the filter no maintenance is required. The filter should be cleaned immediately after installation, a month later and then every other year or when refilling fluid to the system. Check the installation regularly.

LK 521 MultiFill® 25
for heat pumps, max. 12 kW

LK 521 MultiFill® 32
for heat pumps, max. 30 kW

LK 521 MultiFill® 50
for heat pumps, max. 50 kW

CAPACITY DIAGRAM

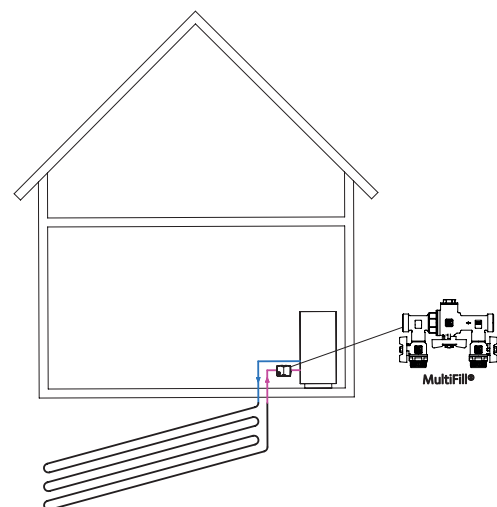
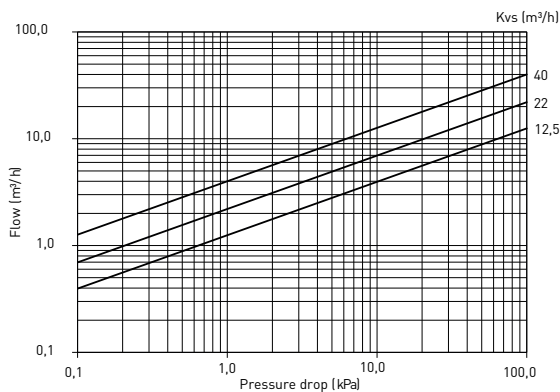

LK 521 - Male Thread

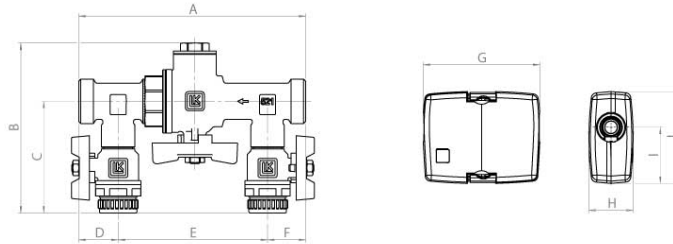

Article no.	Dim. 1	Dim. 2	Kvs m ³ /h	A mm	B mm	C mm	D mm	E mm	F mm	G mm	H mm	I mm	J mm	Weight kg
091480	M 1"	M 3/4"	12.5	170	127	83	29	108	29	218	83	105	171	1.3
091481	M 1 1/4"	M 3/4"	22	173	136	87	29	115	29	218	83	105	171	1.7

Dimension 1 - Pipe connection to collector hose

Dimension 2 - Connection for filling of fluid

Dimensions according to dimensional drawings are guidance and not part of the specification

LK 521 - Male thread

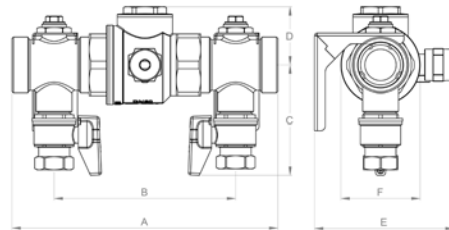

Article no.	Dim. 1	Dim. 2	Kvs m ³ /h	A mm	B mm	C mm	D mm	E mm	F mm	Weight kg
091483	M 2"	M 1"	40	284	194	117	62	149	84,5	4.6

Dimension 1 - Pipe connection to collector hose

Dimension 2 - Connection for filling of fluid

Dimensions according to dimensional drawings are guidance and not part of the specification

SPARE PARTS AND ACCESSORIES

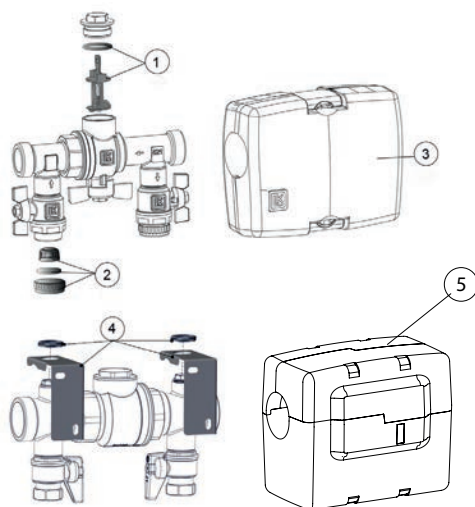

Article no.	Article	Position
095070	Filter and sealing DN 25	1
095071	Filter and sealing DN 32	1
095073	Cap, filter and sealing	2
095072	LK Insulation - DN 25-32	3
095311	Bracket - 521 Multifill DN50	4
187309	LK Insulation, DN50	5

LK 538 ThermoFill® EA



TECHNICAL DATA

Working temperature	Min. 5 °C/Max. 90 °C
Max. working pressure	1.0 MPa (10 bar)
Opening pressure check valve	1 kPa (0,01 bar)
Thread standard	G - male thread
Material, valve body	DZR Brass EN 12165 CW625N
Check valve	Type EA according to EN 1717
Material, check valve	POM
Material, sealing	EPDM

LK 538 ThermoFill® EA is a filling valve for heating systems. The valve has an integrated shut-off/check valve which ensures opening even at low pressure differences. The check valve is inspectionable and classified as a back flow preventer Type EA according to EN 1717.

The arrow on the valve body indicates the direction of the flow.

Male threads are sealed in the usual manner. Both the inlet side as well as the outlet side are designed according to the LK Armatur O-ring seal system. When connecting to this system, tighten first by hand until stop, then another 0.5-1.5 turns with an appropriate tool into the right position.

CAPACITY DIAGRAM

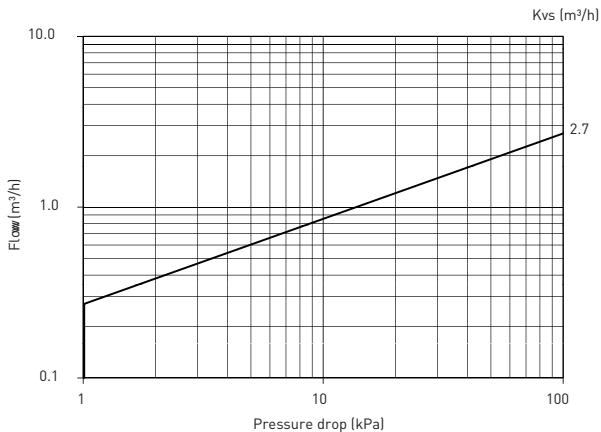

It is easier to fit the compression fitting if a lubricant is applied to the thread and bevel. Tighten first by hand and then with a box spanner. Number of turns to be tightened with a spanner: See the separate datasheet for compression fittings. Soft pipes are to be fitted with a support sleeve.

LK 538 - Male thread

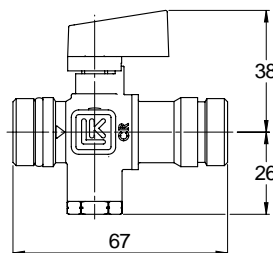

Article no.	Dimension	Kvs m³/h	Weight kg
090268	M 1/2"	2.7	0.1

LK 538 - Male thread / Compression fitting

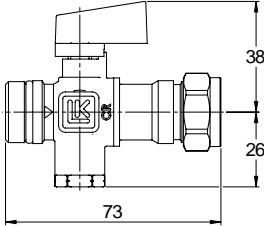

Article no.	Dimension	Kvs m ³ /h	Weight kg
090269	M 1/2" / 15 mm	2.7	0.2

LK 538 - Compression fitting

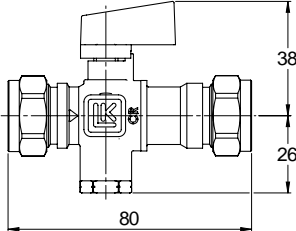

Article no.	Dimension	Kvs m ³ /h	Weight kg
090271	15 mm	2.7	0.2

LK 539 ThermoFill® EA



TECHNICAL DATA

Working temperature	Min. 5 °C/Max. 90 °C
Max. working pressure	1.0 MPa (10 bar)
Opening pressure check valve	1 kPa (0,01 bar)
Thread standard	G - male thread
Material, valve body	DZR Brass EN 12165 CW625N
Check valve	Type EA according to EN 1717
Material, check valve	POM
Material, sealing	EPDM

LK 539 ThermoFill® EA is a filling valve for heating systems. The valve has an integrated shut-off/check valve, which ensures opening even at low pressure differences. The check valve is inspectionable and classified as a back flow preventer Type EA according to EN 1717.

The arrow on the valve body indicates the direction of the flow.

Male threads are sealed in the usual manner, alternatively M 3/4" flat connection with captive nut and flat gasket.

CAPACITY DIAGRAM

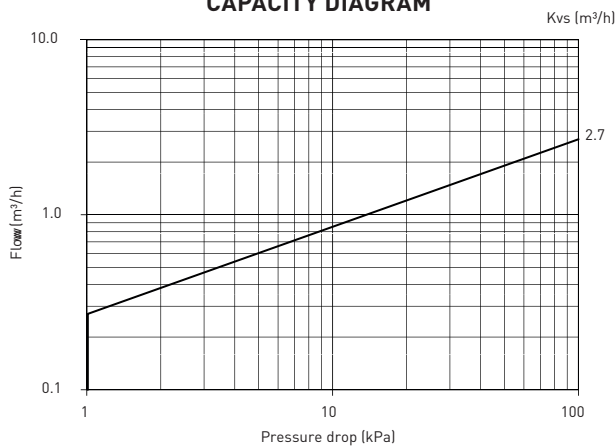

LK 539 - Male thread

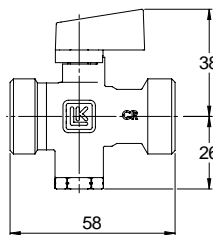

Article no.	Dimension	Kvs m³/h	Weight kg
068008	M 3/4"	2.7	0.2

Valves for Water Heating



LK 510/511/512 MultiSafe

Safety relief valves for tap water installations and heating systems.



LK 514 MultiSafe

Safety relief valve for tap water installations and heating systems.



LK 548 AquaKit

Valve combination for water heating.



LK 550 AquaMix

Mixing valve for water heating.



LK 551 HydroMix

Mixing valve with an anti-scald function, for water heating.



LK 551 HydroKit Solar

Valve combination, designed to energy optimize water heating with solar collectors and an additional heat source.



LK 551 HydroKit HWC

Valve combination for hot water circulation.



LK 510/511/512 MultiSafe



TECHNICAL DATA

Working temperature	Min. -15 °C/Max. 90 °C (120 °C briefly)
Thread standard	G - male thread, G - female thread
Material, valve body	DZR Brass EN 12165 CW625N
Material, sealing	EPDM



LK 510/511/512 MultiSafe is a safety relief valve for tap water installations, as well as heating systems with closed boiler system with a power of max.50 kW. The valve must not be used for steam. The outlet is fitted with compression fitting for simple installation of a discharge pipe.

The safety relief valve can be installed horizontally or vertically, i.e. with the valve knob facing outwards or upwards. In horizontal installations the outlet must be positioned so that a water pocket cannot be formed.

The thread has to be sealed in the usual manner. It is easier to fit the compression fitting if a lubricant is applied to the thread and bevel. Tighten first by hand and then with a box spanner. Number of turns to be tightened with a spanner: See the separate datasheet for compression fittings. Soft pipes are to be fitted with a support sleeve.

The safety relief valve requires no maintenance. The opening function should, however, be checked 2-3 times a year.: Turn the knob counterclockwise by hand, until water flows out. Let the water flush through for a moment. Then turn the knob until a click is heard, about ¼ turn, and the valve returns to closed position.

The safety relief valve may open after a large discharge from the water heater. This is a normal function since the pressure relief level in the water heater can be reached due to the increased volume of the water when heated.

LK 510 - Female thread / Compression fitting - Tap water

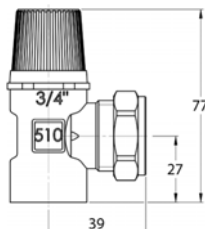

Article no.	Dimension	Opening pressure	Discharge capacity	Weight kg
090033	F ¾" / 22 mm	0.9 MPa	112 l/min.	0.2
090034	G¾ female/22mm	1.0 MPa	133 l/min.	0.2

LK 510 - Female thread / Compression fitting - Heating

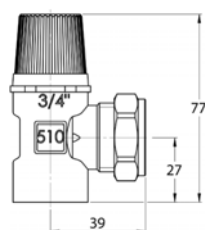

Article no.	Dimension	Opening pressure	Discharge capacity	Weight kg
090030	F ¾" / 22 mm	0.15 MPa	35 l/min.	0.2
090035	F ¾" / 22 mm	0.2 MPa	35 l/min.	0.2
090031	F ¾" / 22 mm	0.25 MPa	38 l/min.	0.2
090036	F ¾" / 22 mm	0.3 MPa	40 l/min.	0.2

LK 511 - Male thread / Compression fitting - Tap water

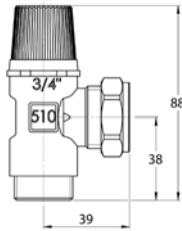

Article no.	Dimension	Opening pressure	Discharge capacity	Weight kg
090043	M 3/4" / 22 mm	0.9 MPa	112 l/min.	0.2
090044	M 3/4" / 22 mm	1.0 MPa	133 l/min.	0,2

LK 511 - Male thread / Compression fitting - Heating

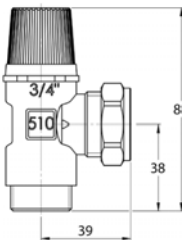

Article no.	Dimension	Opening pressure	Discharge capacity	Weight kg
090040	M 3/4" / 22 mm	0.15 MPa	35 l/min.	0.2
090047	M 3/4" / 22 mm	0.2 MPa	35 l/min.	0.2
090041	M 3/4" / 22 mm	0.25 MPa	38 l/min.	0.2
090048	G3/4 male/22 mm	0.3 MPa	40 l/min.	0.2

LK 512 - Compression fitting - Tap water

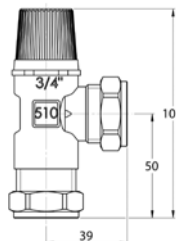

Article no.	Dimension	Opening pressure	Discharge capacity	Weight kg
090053	22 mm	0.9 MPa	112 l/min.	0.3
090054	22 mm	1.0 MPa	133 l/min.	0.3

LK 512 - Compression fitting - Heating

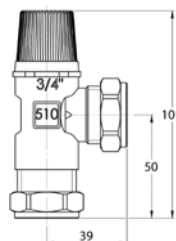

Article no.	Dimension	Opening pressure	Discharge capacity	Weight kg
090050	22 mm	0.15 MPa	35 l/min.	0.3
090051	22 mm	0.25 MPa	38 l/min.	0.3

LK 514 MultiSafe



TECHNICAL DATA

Working temperature	Min. -15 °C/Max. 90 °C (120 °C briefly)
Thread standard	G - male thread
Material, valve body	DZR Brass EN 12165 CW625N
Material, sealing	EPDM



LK 514 MultiSafe is a high lift, soft sealing safety relief valve for tap water installations as well as heating, recycling and cooling systems with thermal expansion only. The valve must not be used for steam. The outlet is fitted with compression fitting for simple installation of a discharge pipe.

The safety relief valve can be installed horizontally or vertically, i.e. with the valve knob facing outwards or upwards. In horizontal installations, the outlet must be positioned so that water pockets cannot be formed.

The male thread is designed for the LK Armatur system with O-ring seal where the valve is first tightened by hand until stop and then with a spanner, 0.5-1.5 turns until the desired position is achieved. If the valve is fitted to other components than an LKA valve, the thread has to be sealed in the usual manner.

The safety relief valve requires no maintenance but the opening function should be checked 2-3 times per year according to the following:

Turn the knob counter-clockwise ¼ turn until a faint "click" is heard. Let the water flush through briefly, then turn another ¼ turn until a stronger "click" is heard and the valve closes.

This two-step opening function makes it possible to use the safety valve discharge pipe to drain e.g. a water heater.

It is normal for the safety relief valve to open and let out some water when the pressure level of the system is reached due to the water's increasing volume during heating.

LK 514 Male thread / Compression fitting

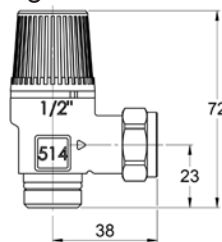

Article no.	Dimension	Opening pressure	Discharge capacity	Weight kg
090109	M ½" / 15 mm	0.15 MPa	31 l/min.*	0.1
090108	M ½" / 15 mm	0.2 MPa	35 l/min.*	0.1
090110	M ½" / 15 mm	0.25 MPa	50 l/min.*	0.1
090111	M ½" / 15 mm	0.3 MPa	81 l/min.*	0.1
090112	M ½" / 15 mm	0.4 MPa	96 l/min.*	0.1
090113	M ½" / 15 mm	0.6 MPa	118 l/min.*	0.1
090114	M ½" / 15 mm	0.7 MPa	104 l/min.*	0.1
090115	M ½" / 15 mm	0.9 MPa	122 l/min.*	0.1
090116	M ½" / 15 mm	1.0 MPa	148 l/min.*	0.1

[According to Swedish Standard VVA 93]

LK 548 AquaKit



TECHNICAL DATA

Working temperature	Min. 5 °C/Max. 90 °C
Operating temperature	Min. 38 °C/Max. 65 °C
Max. working pressure	1.0 MPa (10 bar)
Opening pressure check valve	5 kPa
Material, valve body	DZR Brass EN 12165 CW625N
Material, sealing	EPDM

LK 548 is AquaKit a valve combination for water heating consisting of a shut-off/check valve and a thermostatic mixing valve. The shut-off valve closes the cold water inlet and has an integrated check valve preventing recirculation of warm water into the incoming cold water pipe. The mixing valve regulates the supply of cold water in order to achieve the desired temperature. The shut-off/check valve has two connections with female thread M 1/2" for fitting of a safety relief valve, vacuum breaker or filling valve.

Arrows on the valve body indicate the direction of the flow.

KV = incoming cold water

VV = incoming hot water

BV = outgoing warm water

CAPACITY DIAGRAM

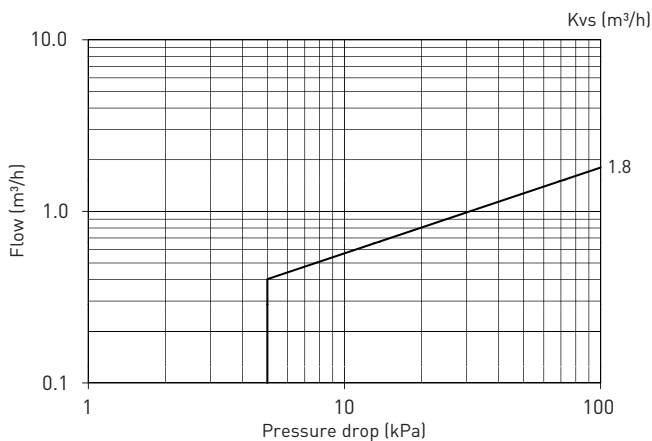

Female thread connections are designed for the LK Armatur O-ring seal system. Other components are fitted in the usual way. When fitting to a male thread connection, adapter LK 373 is used - see under Accessories.

When fitted on top of boiler/storage tanks with built-in water heaters the valve combination should be installed with some space between boiler/storage tank and valve combination so as not to let the function of the valve combination be affected by heat radiation.

The valve knob is used to set the desired warm water temperature within the range of 38 °C to 65 °C. The maximum temperature can be calibrated as follows:

INCREASING THE MAXIMUM TEMPERATURE:

Turn the knob anticlockwise to (+). Loosen the screw and move the knob out to the side. Then turn the knob clockwise to (-) without it being engaged. Adjustments are carried out in small steps. A 1/4 turn corresponds to approximately 7 °C. Reinstall the knob and check that it engages with the teeth. Tighten the screw and then turn the knob to max (+). Max calibration for increasing the temperature is a 1/2 turn.

REDUCING THE MAXIMUM TEMPERATURE:

Do the procedure in reverse. Turn the knob clockwise to (-) and the disengaged knob anticlockwise to (+).

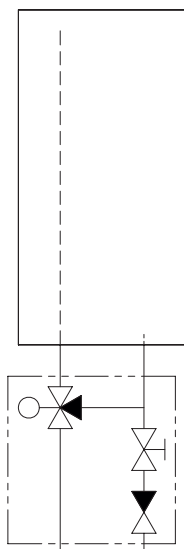

LK 548 - Compression fitting

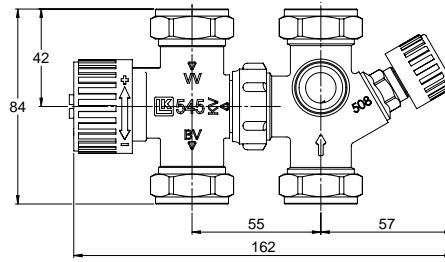

Article no.	Dimension	Kvs m ³ /h	Weight kg
090085	22 mm	1.8	0.7

SPARE PARTS AND ACCESSORIES

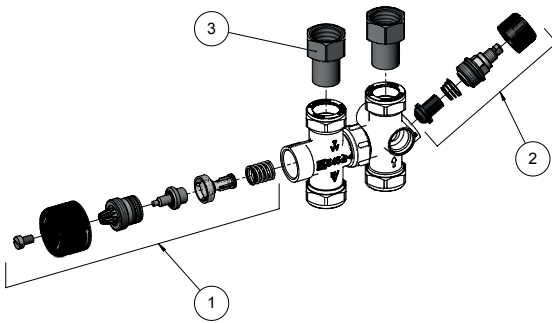

Article no.	Article	Position
4920723	LK 683 Repair kit Mixing valve	1
4311733	LK 684 Repair kit Shut-off/Check valve	2
1898055	LK 373 Adaptor 22 x G 3/4"	3

LK 550 AquaMix



TECHNICAL DATA

Working temperature	Min. 5 °C/Max. 90 °C
Operating temperature	Min. 38 °C/Max. 65 °C
Max. working pressure	1.0 MPa (10 bar)
Thread standard	G - male thread
Material, valve body	DZR Brass EN 12165 CW625N
Material, sealing	EPDM

LK 550 AquaMix is a mixing valve for water heating with a thermostatic element that regulates the supply of cold water in order to achieve the desired temperature. Self-circulation is prevented with a check valve installed in the cold water supply - see under Accessories. Valves with male thread M 1/2" and 15 mm compression fitting have an airvent for simple draining of smaller water heaters.

Arrows on the valve body indicate the direction of the flow.

KV = incoming cold water

VV = incoming hot water

BV = outgoing warm water

When fitting to a male thread connection adapter LK 373 is used - see under Accessories.

When fitted on top of boiler/storage tanks with built-in water heaters the valve should be installed with some space between boiler/storage tank and valve so as not to let the function of the valve be affected by heat radiation.

The valve knob is used to set the desired warm water temperature within the range of 38 °C to 65 °C. The maximum temperature can be calibrated as follows:

INCREASING THE MAXIMUM TEMPERATURE:

Turn the knob anticlockwise to (+). Loosen the screw and move the knob out to the side. Then turn the knob clockwise to (-) without it being engaged. Adjustments are carried out in small steps. A 1/4 turn corresponds to approximately 7 °C. Reinstall the knob and check that it engages with the teeth. Tighten the screw and then turn the knob to max (+). Max. calibration for increasing the temperature is a 1/2 turn.

REDUCING THE MAXIMUM TEMPERATURE:

Do the procedure in reverse. Turn the knob clockwise to (-) and the disengaged knob anticlockwise to (+).

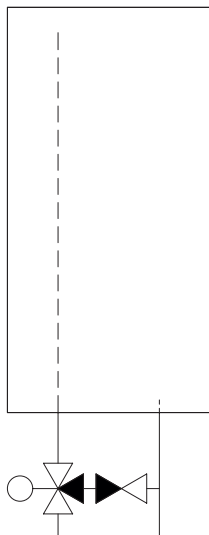
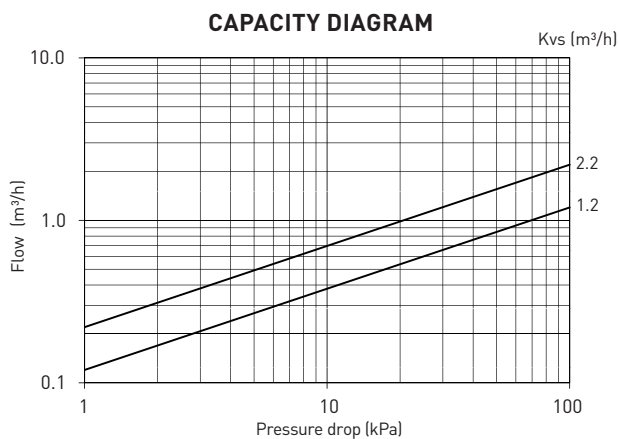

LK 550 - Male thread

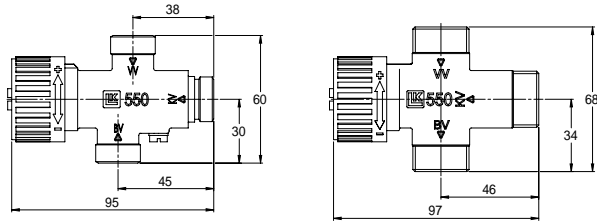

Article no.	Dimension	Kvs m ³ /h	Weight kg
090206	M 1/2"	1.2	0.3
090063	M 3/4"	2.2	0.4
090528	M 1"	2.2	0,5

LK 550 - Compression fitting

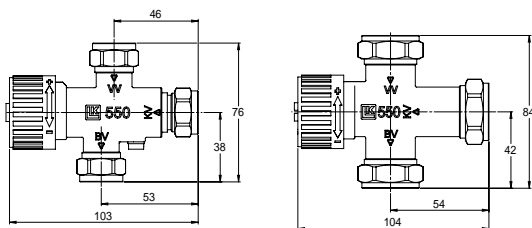

Article no.	Dimension	Kvs m ³ /h	Weight kg
090200	15 mm	1.2	0.3
090205	22 mm	2.2	0.4

SPARE PARTS AND ACCESSORIES

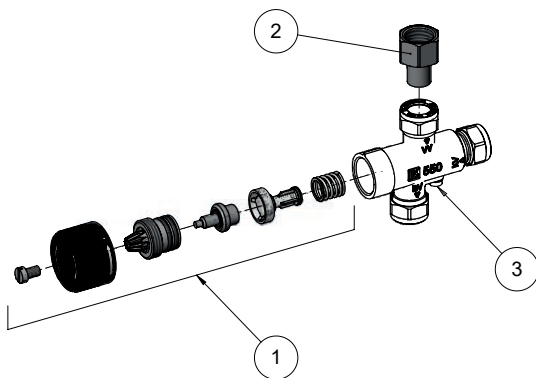

Article no.	Article	Position
4920723	LK 683 Repair kit Mixing valve	1
1898055	LK 373 Adaptor 22 x G 3/4"	2
052002	LK 373 Adaptor 15 x G 1/2"	2
055008	Check valve NN 1/2"	-
055009	Check valve NN 3/4"	-
092105	Cartridge Check valve 15 mm	-
092103	Cartridge Check valve 22 mm	-
187224	Airscrew	3

LK 551 HydroMix



WRAS
APPROVED
PRODUCT



TECHNICAL DATA

Working temperature	Min. 5 °C/Max. 65 °C Min. 5 °C/Max. 95 °C
Operating temperature	Min. 10 °C/Max. 35 °C (Max. 65 °C) Min. 25 °C/Max. 45 °C Min. 35 °C/Max. 55 °C Min. 35 °C/Max. 65 °C
Max. working pressure	1.0 MPa (10 bar)
Media 1	Water - Ethylene glycol mixture max. 50%
Media 2	Water - Propylene glycol mixture max. 50%
Media 3	Water - Ethanol mixture max. 50%
Thread standard	Rp - female thread, G - male thread
Material, valve body	DZR Brass EN 12165 CW625N Brass EN 12165 CW617N
Temperature stability	±3 °C

LK 551 HydroMix is a mixing valve for water heating and heating systems. The mixing valve has a thermostatic element that regulates the supply of cold as well as hot water in order to achieve the desired temperature. The valve has an anti-scald function that shuts off the incoming hot water flow in case of failure of cold water supply.

Arrows on the valve body indicate the direction of the flow.

C = incoming cold water

H = incoming hot water

M = outgoing mixed water

When fitted on top of boiler/storage tanks with built-in water heaters the valve should be installed with some space between boiler/storage tank and valve so as not to let the function of the valve be affected by heat radiation.

The valve knob is used to set the desired warm water temperature within the specified range. The protective cap prevents unintentional changes of the temperature setting.

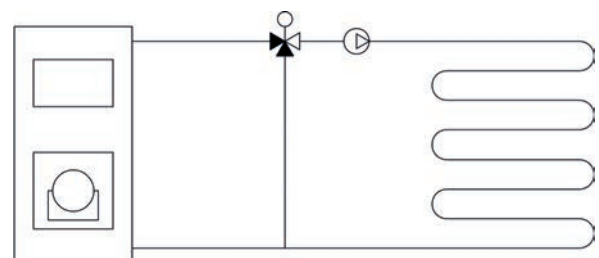
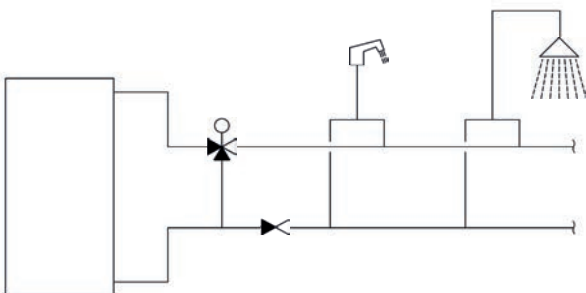
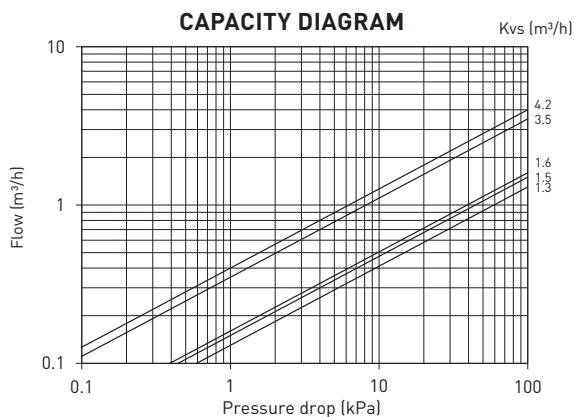

LK 551 - Female thread

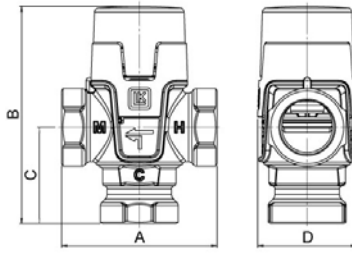

Article no.	Dimension	Kvs m ³ /h	A mm	B mm	C mm	D mm	Note	Weight kg
181616	F 1/2"	1.5	70	99	43,5	45	25 °C - 45 °C	0.5
181617	F 3/4"	1.6	70	99	43,5	45	25 °C - 45 °C	0.5
181455	F 1/2"	1.5	70	99	43,5	45	35 °C - 65 °C	0.5
181486	F 3/4"	1.6	70	99	43,5	45	35 °C - 65 °C	0.5
182203	F 1"	3.5	84	121	62	55	10 °C - 35 °C *	0.9
182204	F 1"	4.2	84	121	62	55	25 °C - 45 °C *	0.9
182205	F 1"	3.5	84	121	62	55	35 °C - 65 °C *	0.9

* Material, valve body: EN 12165 CW617N

LK 551 - Male thread

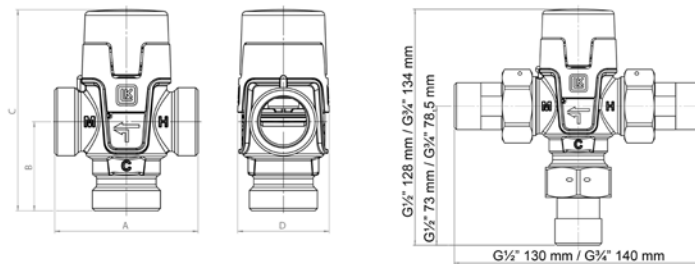

Article no.	Dimension	Kvs m ³ /h	A mm	B mm	C mm	D mm	Note	Weight kg
181618	M 1/2"	1.3	70	42,5	99	45	25 °C - 45 °C	0.4
181619	M 3/4"	1.5	70	43,5	99	45	25 °C - 45 °C	0.5
181620	M 1"	1.6	70	43,5	99	45	25 °C - 45 °C	0.5
181452	M 1/2"	1.3	70	42,5	99	45	35 °C - 65 °C	0.4
181453	M 3/4"	1.5	70	43,5	99	45	35 °C - 65 °C	0.5
181454	M 1"	1.6	70	43,5	99	45	35 °C - 65 °C	0.5
182197	M 1"	3.5	84	62	121	55	10 °C - 35 °C *	0.7
182198	M 1"	3.5	84	62	121	55	25 °C - 45 °C *	0.7
182199	M 1"	3.5	84	62	121	55	35 °C - 65 °C *	0.7
182200	M 1 1/4"	3.5	84	62	121	55	10 °C - 35 °C *	0.8
182201	M 1 1/4"	4.2	84	62	121	55	25 °C - 45 °C *	0.8
182202	M 1 1/4"	3.5	84	62	121	55	35 °C - 65 °C *	0.8

* Material, valve body: EN 12165 CW617N

LK 551 - Compression fitting

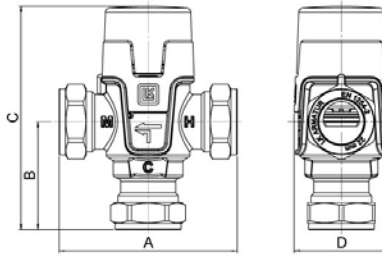

Article no.	Dimension	Kvs m ³ /h	A mm	B mm	C mm	D mm	Note	Weight kg
181621	15 mm	1.3	86,5	51	106	45	25 °C - 45 °C	0.4
181622	22 mm	1.6	85	52	106	45	25 °C - 45 °C	0.4
181523	15 mm	1.3	86.5	51	106	45	35 °C - 55 °C	0.5
181487	22 mm	1.6	85	52	106	45	35 °C - 55 °C	0.6
181456	15 mm	1.3	86.5	51	106	45	35 °C - 65 °C	0.5
181457	22 mm	1.6	85	52	106	45	35 °C - 65 °C	0.6
182206	28 mm	3.5	110	80	138	55	10 °C - 35 °C	0.9
182207	28 mm	4.2	110	80	138	55	25 °C - 45 °C	0.9
182208	28 mm	3.5	110	80	138	55	35 °C - 65 °C	0.9

SPARE PARTS AND ACCESSORIES

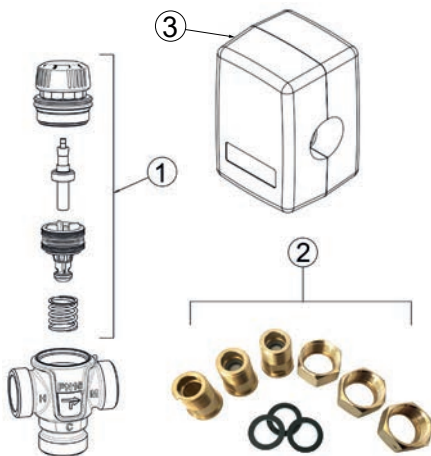

Article no.	Article	Position
095234	Repair kit 551, 35 °C - 65 °C	1
095236	Repair kit 551, 35 °C - 55 °C	1
095235	Repair kit 551, 25 °C - 45 °C	1
095348	Repair kit 551, 10 °C - 35 °C (Kvs 3.2-4.2)	1
095349	Repair kit 551, 35 °C - 65 °C (Kvs 3.2-4.2)	1
095350	Repair kit 551, 25 °C - 45 °C (Kvs 3.2-4.2)	1
092052	Connection kit M 3/4" x 1" with rotating nut, gaskets, 1 check valve	2
092053	Connection kit M 3/4" x 1" with rotating nut, gaskets, 2 check valves	2
092054	Connection kit M 1/2" x 3/4" with rotating nut, gaskets, 1 check valve	2
092055	Connection kit M 1/2" x 3/4" with rotating nut, gaskets, 2 check valves	2
092333	Connection kit M 1" x 1 1/4" with rotating nut, gaskets, 1 check valve	2
092334	Connection kit M 1" x 1 1/4" with rotating nut, gaskets, 2 check valves	2
187304	LK Insulation 551 (Kvs 1.3-1.6)	3
187310	LK Insulation 551 (Kvs 3.2 -4.2)	3

LK 551 F HydroMix



TECHNICAL DATA

Working temperature	Min. 5 °C/Max. 95 °C
Diverting temperature	Min. 42 °C/Max. 52 °C
Max. working pressure	1.0 MPa (10bar)
Media 1	Water - Ethylene glycol mixture max. 50%
Media 2	Water - Propylene glycol mixture max. 50%
Media 3	Water - Glycol/Ethanol mixture max. 50%
Thread standard	Rp - female thread, G - male thread
Material, valve body	DZR Brass EN 12165 CW625N
Temperature stability	±3 °C

The LK 551 HydroMix F is a 3-way temperature regulating liquid distribution valve. Once the liquid exceeds the temperature setting on the valve, it will be redirected to port C. If the temperature of the liquid falls below the set level, it will be redirected to port M.

Arrows on the valve body indicate the direction of the flow.

- H = incoming water
- C = outgoing hot water
- M = outgoing cold water

When fitted on top of boiler/storage tanks with built-in water heaters the valve should be installed with some space between boiler/storage tank and valve so as not to let the function of the valve be affected by heat radiation.

The valve knob is used to set the desired warm water temperature within the specified range. The protective cap prevents unintentional changes of the temperature setting.

The valve requires no maintenance but the installation should be checked regularly.

CAPACITY DIAGRAM

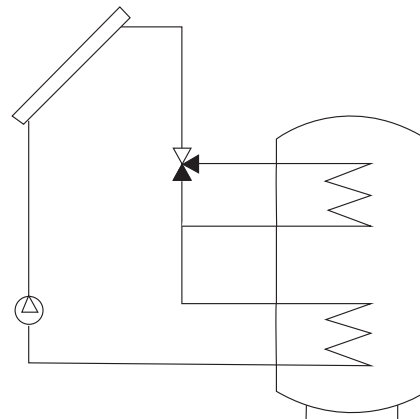
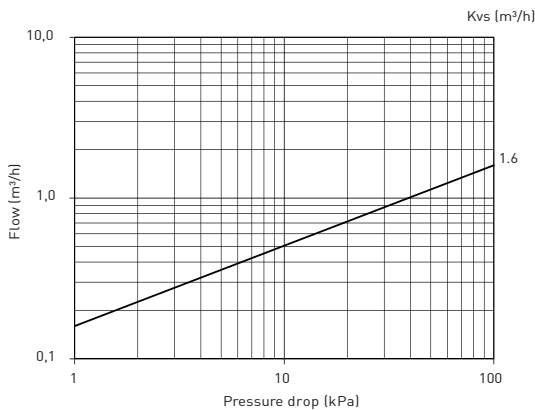

LK 551 F - Male thread

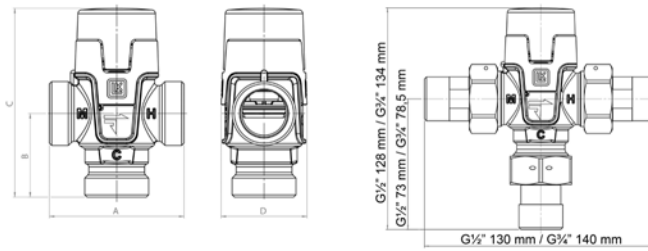

Article no.	Dimension	Kvs m ³ /h	A mm	B mm	C mm	D mm	Note	Weight kg
182143	M 1"	1.6	70	43,5	99	45	42 °C - 52 °C	0.5

SPARE PARTS AND ACCESSORIES

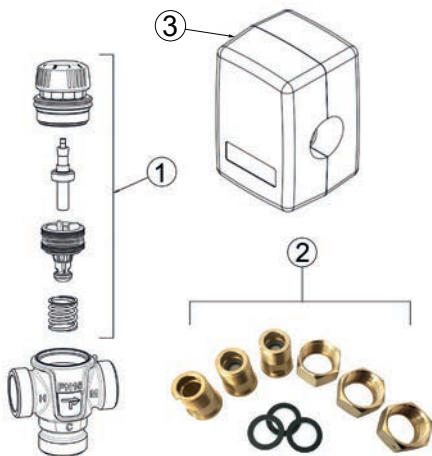

Article no.	Article	Position
095075	Repair kit 551 F, 42 °C - 52 °C	1
092052	Connection kit M 3/4" x 1" with rotating nut, gaskets, 1 check valve	2
092053	Connection kit M 3/4" x 1" with rotating nut, gaskets, 2 check valves	2
092054	Connection kit M 1/2" x 3/4" with rotating nut, gaskets, 1 check valve	2
092055	Connection kit M 1/2" x 3/4" with rotating nut, gaskets, 2 check valves	2
187304	LK Insulation 551	3

LK 551 HydroKit Solar



TECHNICAL DATA

Working temperature	Min. 5 °C/Max. 95 °C
Diverting temperature	Min. 42 °C/Max. 52 °C
Operating temperature	Min. 35 °C/Max. 65 °C
Max. working pressure	1.0 MPa (10 bar)
Media 1	Water - Ethylene glycol mixture max. 50%
Media 2	Water - Propylene glycol mixture max. 50%
Media 3	Water - Ethanol mixture max. 50%
Thread standard	Rp - female thread, G - male thread
Material, valve body	DZR Brass EN 12165 CW625N
Temperature stability	±3 °C



LK 551 HydroKit Solar is a valve combination, designed to energy optimize water heating with solar collectors and an additional heat source. In order to maintain the set water temperature, the warm water from the solar system is mixed and led directly to the mixed water outlet or if needed diverted to the additional heat source for further heating.

LK 551 HydroKit Solar has two thermic valves; one diverting valve and one with anti-scald function. The warm water temperature, for the mixing valve, is adjustable within the range of 35 °C to 65 °C and for the diverting valve the temperature is adjustable within the range of 42 °C to 52 °C.

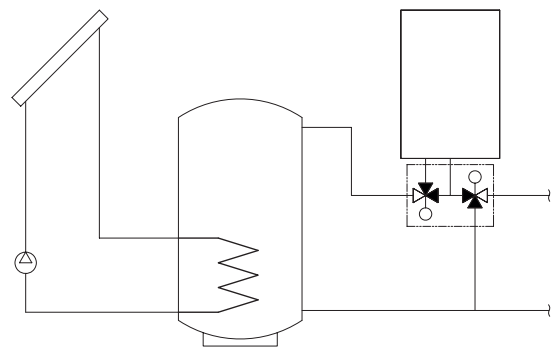

LK 551 HydroKit Solar - with connection kit

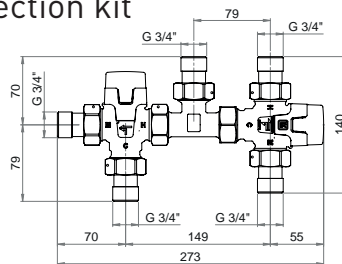

Article no.	Dimension	Note	Weight kg
181588	M 3/4"	Connection kit included: contains nuts, gaskets, fittings (5 pcs of each) check valves (2 pcs).	1.6

LK 551 HydroKit Solar

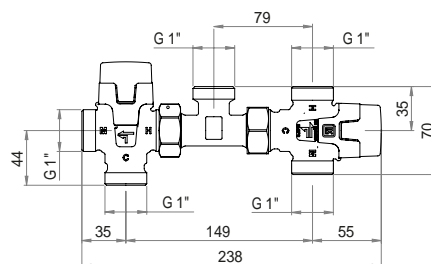

Article no.	Dimension	Weight kg
181690	M 1"	1.6

LK 551 HydroKit HWC



TECHNICAL DATA

Working temperature	Min. 5 °C/Max. 95 °C
Operating temperature	Min. 35 °C/Max. 65 °C
Max. working pressure	1.0 MPa (10 bar)
Media 1	Water - Ethylene glycol mixture max. 50%
Media 2	Water - Propylene glycol mixture max. 50%
Media 3	Water - Ethanol mixture max. 30%
Thread standard	G - male thread
Material, valve body	DZR Brass EN 12165 CW625N
Temperature stability	±3°C

LK 551 HydroKit HWC is a compact unit for hot water circulation. Hot water circulation offers instantly available hot water at a tap, so you don't have to wait on hot water. Hot water circulation is especially useful in buildings with long water pipes.

LK 551 HydroKit HWC consists of a mixing valve, cross, connection kit and 3 check valves, to prevent self circulation. The mixing valve has a thermostat that regulates the supply of both cold and hot water to the desired temperature. The valve has an anti-scald function that closes for incoming hot water in case the cold water supply ends.

CAPACITY DIAGRAM

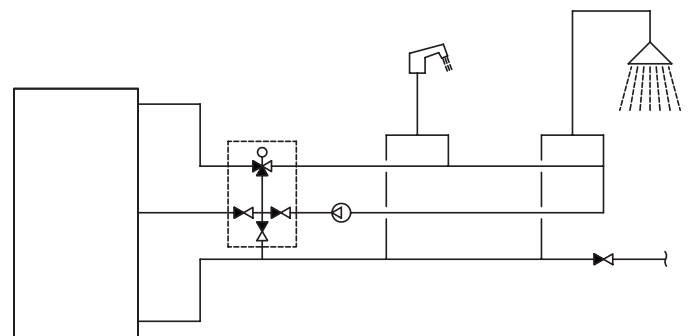
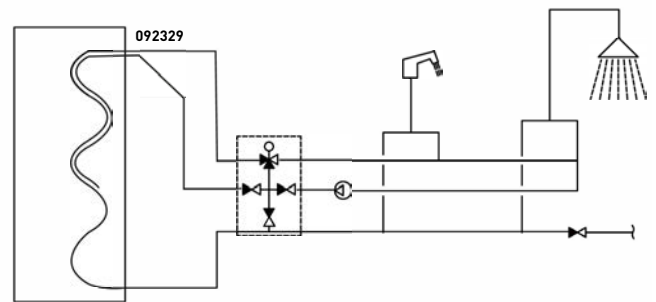
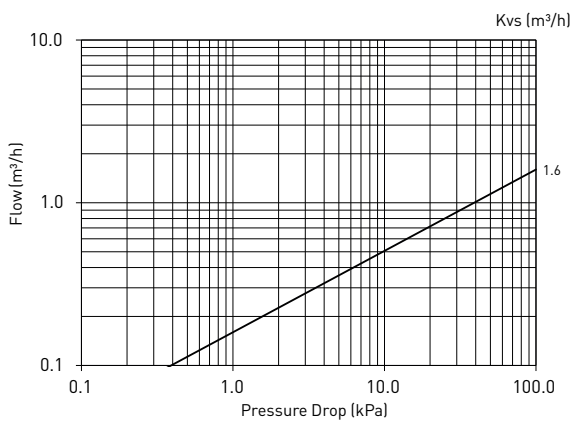

LK 551 HydroKit HWC

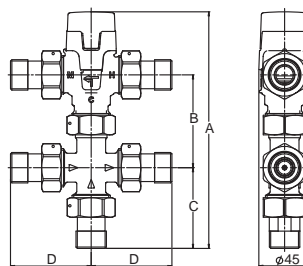

Article no.	Dimension	Kvs m ³ /h	A mm	B mm	C mm	D mm	Note	Weight kg
091782	M 3/4"	1.6	205	81	70	70	35 °C - 65 °C	1.4

SPARE PARTS AND ACCESSORIES

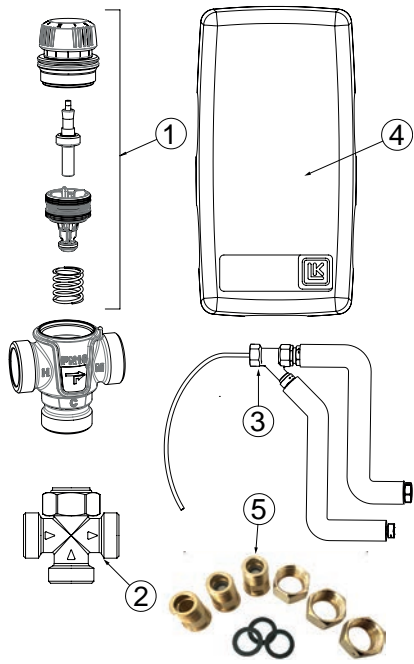

Article no.	Article	Position
095234	Repair kit 551, 35 °C - 65 °C	1
092325	Fitting	2
092329	LK CirculationKit HWC	3
187305	LK Insulation HWC	4
092052	Connection kit M ¾" x 1" with rotating nut, gaskets, 1 check valve	5
092053	Connection kit M ¾" x 1" with rotating nut, gaskets, 2 check valves	5
092054	Connection kit M ½" x ¾" with rotating nut, gaskets, 1 check valve	5
092055	Connection kit M ½" x ¾" with rotating nut, gaskets, 2 check valves	5

Products for Underfloor Heating



LK 420 MiniShunt 2.0

Thermostat controlled unit for connection of small underfloor heating systems to an existing heating system.



LK 421 Manifold Shunt

Complete pre-manufactured shunt unit with a 2-way control valve for systems with the main pump in the primary circuit.



LK 422 Manifold Shunt Tmax

The shunt unit is used in systems with a main pump.

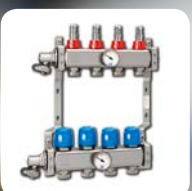

LK 430 Manifold

Manifold for 2 – 12 underfloor heating circuits.



LK 435 OptiFlow

Group valve for flow adjustment.



LK 440 EasyHeat

Portable boiler.



LK 460 EasyHeat

Portable boiler.



LK 420 MiniShunt 2.0



TECHNICAL DATA

Voltage	1 phase 230V+10%/-15%, 50/60 Hz, PE
Power consumption	Max 45 W
Working temperature	Primary Max. 80 °C Secondary Min. 12 °C/Max. 55 °C
Ambient temp.	Max. 60 °C
Max. working pressure	0.6 MPa (6 bar)
Max. differential pressure	0.1 MPa (1 bar)
Media 1	Water - Glycol mixture max. 50%
Media 2	Water - Ethanol mixture max. 30%
Thread standard	Rp - female thread, G - male thread
Protection type	IP X4D
Material, valve body	Nickel-plated Brass EN 12165 CW617N
Circulating pump	Wilo Yonos PARA RSB 15/6-RKA
Max Valve capacity	Kvs 1.05
Max. valve capacity with selfacting thermostat installed.	Max. at room temperature approx. 20 °C Kv 0.9
Approved pump	CE, EC Low Voltage Directive (2006/95/EC) incl. additions

LK 420 MiniShunt 2.0 is a shunt group intended for use when smaller underfloor heating areas are to be connected to an existing heating system. LK MiniShunt adapts the heating system temperature to the lower temperature necessary for the underfloor heating system. Its capacity can normally be set at a heating need of 50 W/m² to a maximum 60 m² underfloor heating area. Capacity is however dependent on primary temperature, pressure, laying method etc.

- For underfloor heating areas up to 60 m².
- Compact design.
- Energy efficient circulation pump.
- Thermostat-controlled maximum limit of supply temperature
- Switchable between single or twin pipe systems.
- VF valve.
- Easy filling and air bleeding.
- Expandable to 2, 3 or 4 underfloor heating circuits.

ITEMS INCLUDED:

- Circulation pump Wilo Yonos Para RSB 15/6-RKA, with automatic speed control, 1 fas 230V AC, 50 Hz, max 45W, 0,44 A
- Thermostat with capillary tube sensor, length 2 m.
- 1 thermometer to place in one of the shunt group's thermometer pockets.
- Hose 0.5 m for air bleeding.
- Primary connector G20 EK and 2 connectors for CU15.
- Bracket.

PUMP CHARACTERISTICS

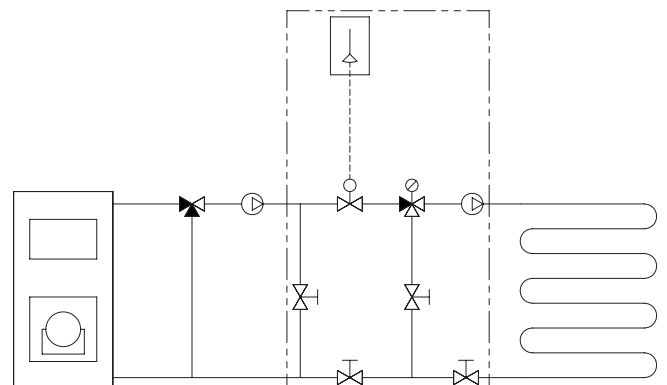
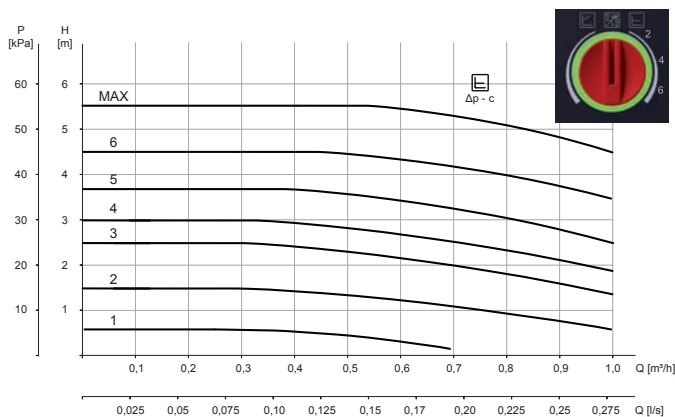

LK 420 - Compression fitting alt. Male thread / Female thread

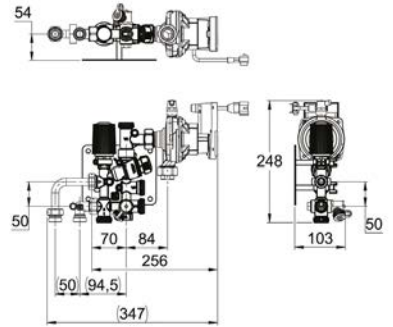
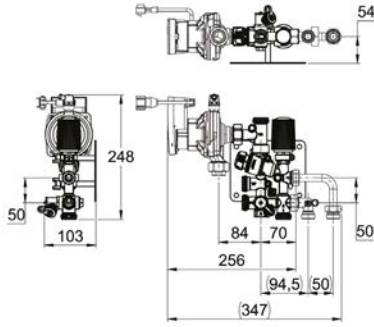

Article no.	Dimension	Kvs m ³ /h	Weight kg
296994	M 3/4" EuroCone / F 1/2"	1.05	4

Dimension = Prim. / Sec. connection

SPARE PARTS AND ACCESSORIES

1



2



Article no.	Article	Position
095312	Circulating pump Wilo Yonos PARA RSB 15/6 RKA	1
055603	Thermostat with sensor	2

LK 421 Manifold Shunt



TECHNICAL DATA

Voltage	1 phase 230V AC, -15 %/+10 %, 50 Hz, PE
Power consumption	Max. 52 W
Working temperature	Primary: Min. 5 °C/Max. 90 °C Secondary: Min. 30 °C/Max. 65 °C
Ambient temp.	Max. 70 °C
Max. working pressure	0.6 MPa (6 bar)
Max. differential pressure	0.1 MPa (1 bar)
Media 1	Water - Glycol mixture max. 50%
Media 2	Water - Ethanol mixture max. 30%
Thread standard	Rp - female thread, G - male thread
Protection type	IP44
Material, valve body	Nickel-plated Brass EN 12165 CW617N
Circulation pump	Grundfos UPM3 AUTO L 15-70
Max. valve capacity control valve V1	Kv 2.2 (with hand actuator fitted)
Max. valve capacity control valve V1	Kvs 3.6 (with electric valve actuator)
Control valve V2	Kvs 4.1
Approved pump	CE, EC Low Voltage Directive (2006/95/EC) incl. additions

LK 421 is to be used in systems with main pump in the primary circuit. Its capacity can be set at a flat rate of heating requirements of 50W/m² to max 200 m² of floor heating surface. The capacity is dependent on the primary temperature, pressure, floor heating installing system, etc. The included supply pipe allows in both left- and righthand assembly to LK Manifold RF.

The shunt unit is a complete pre-manufactured unit.

ITEMS INCLUDED:

- Circulation pump Grundfos UPM3 Auto L 15-70 130, with automatic speed control, 1 phase 230 V AC 50 Hz, max 45 W, 0.38 A
- Two way control valve Kvs value 2.5, equipped with hand actuator
- VF valve
- Temperature limiter of feed temperature
- Adjustment valve for the primary circuit
- Check valve
- 2 tube thermometers
- Isolation valves for primary circuit
- Fixing bracket

PUMP CHARACTERISTICS

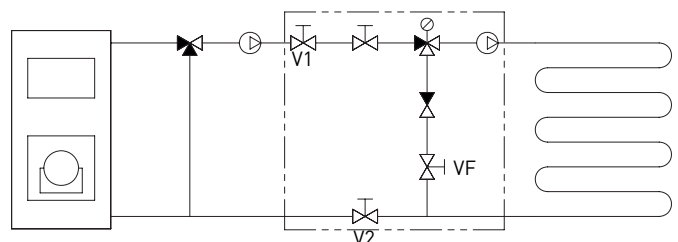
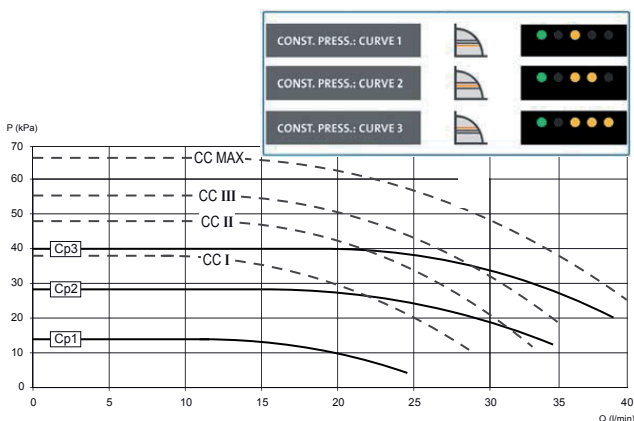

LK 421 - Female thread / Male thread

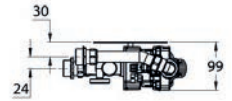
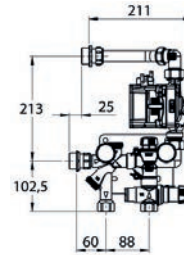
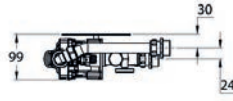
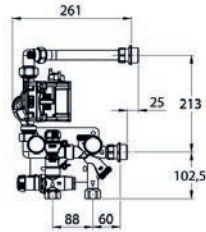

Article no.	Dimension	Weight kg
296995	F 3/4" / M 1"	4.6

Dimension = Prim. / Sec. connection

SPARE PARTS AND ACCESSORIES

1



2



3

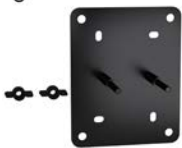

Article no.	Article	Position
187172	Circulating pump Grundfos UPM3 Auto L 15/70	1
095018	Thermometer T40, 0 °C - 80 °C	2
095221	Bracket	3

LK 422 Manifold Shunt Tmax



TECHNICAL DATA

Voltage	1 phase 230V AC, -15 %/+10 %, 50 Hz, PE
Working temperature	Primary: Min. 5 °C/Max. 90 °C Secondary: Min. 30 °C/Max. 65 °C
Ambient temp.	Max. 70 °C
Max. working pressure	0.6 MPa (6 bar)
Max. differential pressure	0.1 MPa (1 bar)
Media 1	Water - Glycol mixture max. 50%
Media 2	Water - Glycol/Ethanol mixture max 30%
Thread standard	G - male thread, G - female thread
Circulating pumps	Grundfos UPM3 AUTO L 15-70
Material, valve body	Nickel-plated Brass EN 12165 CW617N
Material, supply pipe	Nickel-plated Brass MS58, stainless acid-proof steel
Cable specification	IP44

LK 422 Manifold Shunt Tmax is used in systems with a main pump. The shunt unit can be mounted directly to LK Manifold RF from the left or right. The shunt unit is fitted as standard with a constant thermostat controlled feed temperature as well as an automatic speed controlled pump for reduced energy consumption and quieter operation. The guideline capacity of this shunt unit is a maximum of 130 m² floor heating surface. The capacity is dependent on heat requirement, laying procedure etc.

LK 422 can be mounted directly onto the manifold from the right or left. A manifold supply pipe for use when mounting to the left of the manifold is supplied. When fitting from the right, shorten the supply pipe by about 50 mm, reposition the thermometers and the pump through 180°.

PUMP CHARACTERISTICS

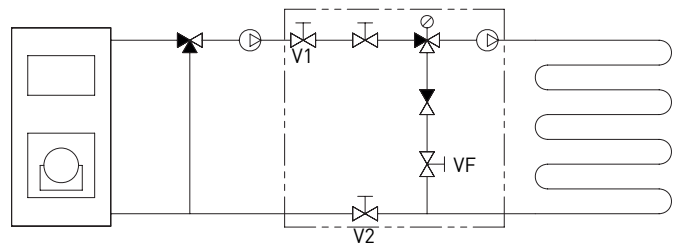
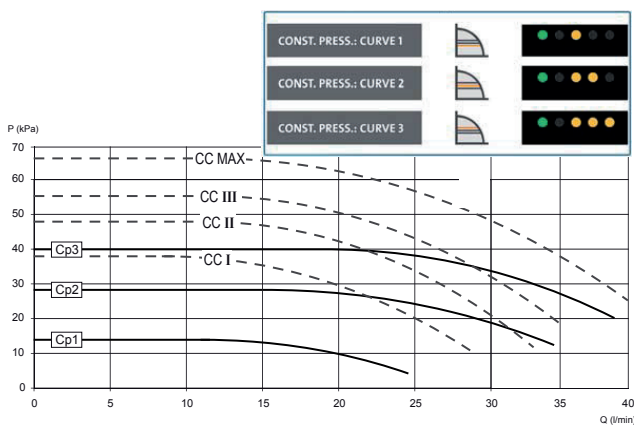

LK 422 - Female thread / Male thread

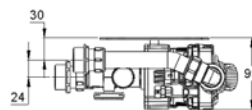
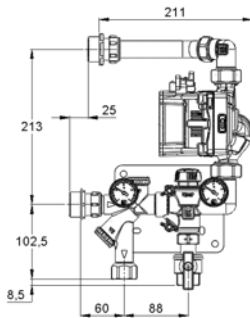

Article no.	Dimension	Kvs m ³ /h	Kvs2 m ³ /h	Weight kg
2419498	F 3/4" / M 1"	2.7	5,0	5.3

SPARE PARTS AND ACCESSORIES

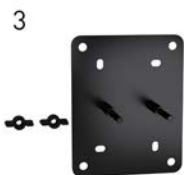

Article no.	Article	Position
187172	Circulating pump Grundfos UPM3 Auto L 15/70	1
095018	Thermometer T40, 0 °C - 80 °C	2
095221	Bracket	3

LK 430 Manifold

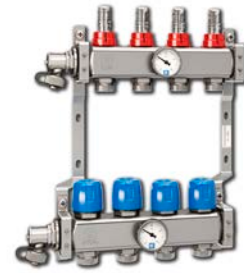

TECHNICAL DATA

Working temperature	Min. +5°C/Max. +70°C (max. +85°C briefly)
Ambient temp.	Min. -20°C/Max. +40°C
Max. working pressure	1.0 MPa (10 bar)
Max. differential pressure	100 kPa (1 bar)
Media 1	Water
Media 2	Water - Ethylene glycol mixture max. 50%
Media 3	Water - Propylene glycol mixture max. 50%
Media 4	Water - Ethanol mixture max. 50%
Thread standard	G - female thread, G - male thread
Flow indication	Scale 0.5 - 5 l/min. ±10%
Thermometer	0° - +80°C
Material, manifold	Stainless steel EN 10088-3 1.4306
Material, threaded union parts/isolation valves	Nickel plated brass EN 12165 CW617N

LK 430 is a manifold for 2 - 12 underfloor heating circuits. It is manufactured in stainless steel and is delivered pre-mounted to a bracket. The manifold is equipped with filling / drainage valves. The upper manifold marked FLOW is fitted with flow indicators and adjustment valves for setting the respective circuit flows. The lower manifold marked RETURN has manually operated valves for shutting off each respective circuit. These valves are normally replaced with thermoelectric actuators. Thermometers for the return and flow manifolds are available - see under Accessories.

LK 430 can also be supplied with an LK 435 OptiFlow balancing valve for easy adjustment of the circuit flow. The flow rate is clearly indicated on a transparent scale - see under Accessories. For more information see the product sheet for OptiFlow.

The heat supply can be connected to the manifold from the left or the right side. The manifold is delivered ready for connection from the left. When connecting from the right, reposition the drainage valves.

VALVE CHARACTERISTICS

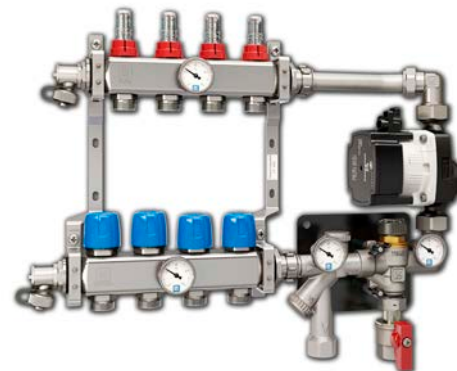
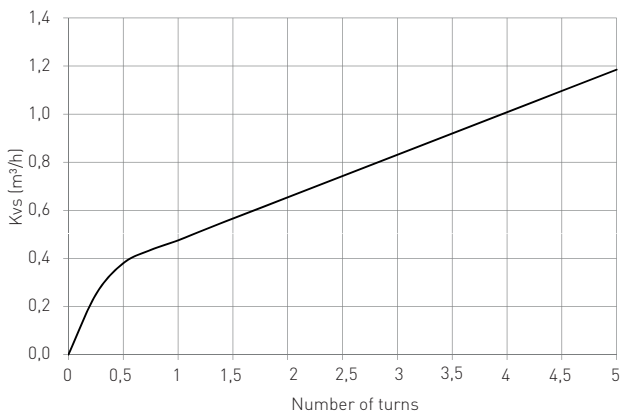

LK 430 - Female thread / Male thread

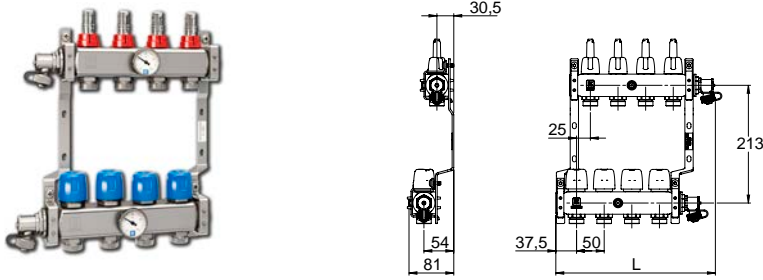

Article no.	Dim. 1	Dim. 2	Dim. 3	Kvs1 m ³ /h	Kvs2 m ³ /h	Number of circuits	L mm	Weight kg
297311	F 1"	M 3/4" EuroCone	M 1/2"	1.1	2,5	2	190	2.8
297312	F 1"	M 3/4" EuroCone	M 1/2"	1.1	2,5	3	240	3.2
297313	F 1"	M 3/4" EuroCone	M 1/2"	1.1	2,5	4	290	3.6
297314	F 1"	M 3/4" EuroCone	M 1/2"	1.1	2,5	5	340	4.2
297315	F 1"	M 3/4" EuroCone	M 1/2"	1.1	2,5	6	390	4.7
297316	F 1"	M 3/4" EuroCone	M 1/2"	1.1	2,5	7	440	5.1
297317	F 1"	M 3/4" EuroCone	M 1/2"	1.1	2,5	8	490	5.7
297318	F 1"	M 3/4" EuroCone	M 1/2"	1.1	2,5	9	540	6.0
297319	F 1"	M 3/4" EuroCone	M 1/2"	1.1	2,5	10	590	6.5
297320	F 1"	M 3/4" EuroCone	M 1/2"	1.1	2,5	11	640	7.0
297321	F 1"	M 3/4" EuroCone	M 1/2"	1.1	2,5	12	690	7.5

SPARE PARTS AND ACCESSORIES

1



Article no.	Article	Position
095018	Thermometer T40, 0°- 80°C	1
090275	LK 435 OptiFlow, 2-16 l/min	2
090276	LK 435 OptiFlow, 4-36 l/min	2
095182	Drainage valve	-

2



LK 435 OptiFlow



TECHNICAL DATA

Working temperature	
Water/Glycol 50/50%	Min. -20 °C/Max. 80 °C (90 °C briefly)
Water/Ethanol 70/30%	Min. -20 °C/Max. 70 °C (85 °C briefly)
Max. working pressure	1.0 MPa (10 bar)
Max. differential pressure	100 kPa (1 bar)
Media	Water - Glycol mixture max. 50% Ethanol mixture max. 30%
Material, valve body	Nickel-plated Brass EN 12165 CW617N
Flow ranges	2-16 l/min, 4-36 l/min
Accuracy, flow meter	+/- 12%
Thread standard, adjustment valve inlet:	G - male thread
Thread standard, adjustment valve outlet:	G - female thread

LK 435 OptiFlow is a group valve for flow adjustment of hydraulic systems such as underfloor heating, traditional heating and cooling systems. Adjustments are easily made using an Allen key. No measuring equipment is needed. The flow rate is read off directly from the visual flow indicator. The flow meter continuously measures and displays the actual flow rate during operation.

LK 435 OptiFlow has a MemoStop function for locking the setting. This means that the valve can be used as a shut-off valve without losing settings. A marking plate for labelling and documenting the setting is enclosed. LK 435 OptiFlow can be supplemented with a thermometer and threaded union parts, straight or angular, with rotating nut for simple assembly to, for example, an LK 430 Manifold RF - see under Accessories. The thermometer is placed in the valve's integrated sensor pocket.

The valve can be mounted in any position. The arrow on the valve body indicates the flow direction. For accurate measurement a straight piece of tube at least of the same length as the valve body should precede the balancing valve. When assembling to an LK 430 Manifold RF the adjustment valve can be fitted directly to the manifold, thus replacing the shut-off valve.

The flow meter is designed so that the fluid does not flow through the glass in order to protect it from debris and dirt. However, after a period of time the glass may still have to be cleaned as the fluid often becomes contaminated and blackened. It is then easy to remove the glass to clean it. The function/setting of the valve is not affected by deposits in the glass. Except for cleaning of the glass, the group valve normally requires no maintenance. The installation should be checked regularly.

VALVE CHARACTERISTICS

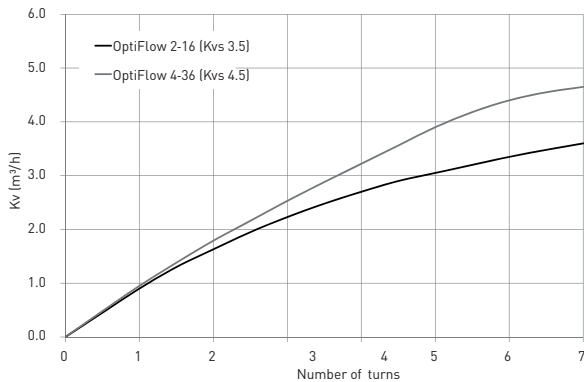

WITH LK 430 MANIFOLD RF

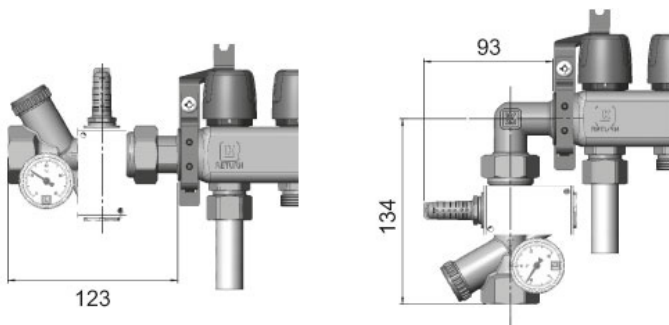

LK 435 - Male thread / Female thread

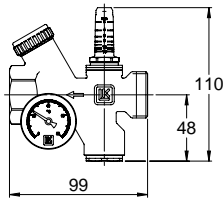

Article no.	Dimension	Kvs m ³ /h	Flow range	Weight kg
090275	Adjustment valve - M 1" / F 1"	3.5	2-16 l/min	0.5
090276	Adjustment valve - M 1" / F 1"	4.5	4-36 l/min	0.5

SPARE PARTS AND ACCESSORIES

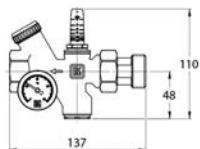

Article no.	Article	Position
095222	Threaded union part straight G 1" with rotating nut	1
095223	Threaded union part angle G 1" with rotating nut	2
095018	Thermometer T40, 0 °C - 80 °C	3

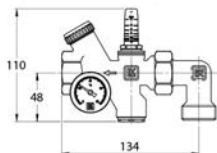

LK 440 EasyHeat



TECHNICAL DATA

Circulating pumps	Grundfos UPM3 AUTO L
Protection class	IP 44
Operating thermostat	Max 60 °C
Safety thermostat	80 °C
Expansion tank	12 l
Safety valve	1,5 bar
Max. glycol solution	30%
Boiler volume	2,8 l

The LK 440 EasyHeat is a complete portable electrically heated boiler. It is primarily meant to be used as a temporary heater, e.g. for drying concrete slabs installed with under floor heating and for heating buildings under construction.

LK 440 EasyHeat is available in two versions, with 3-phase 400V or 1-phase 230V.

The total output capacity on 3-phase 400V is 9 kW and works in two steps of 4.5 kW.

The total output capacity on 1-phase 230V can be manually set between 2 or 3 kW.

The boiler is supplied complete with a circulation pump, an expansion tank, and auxiliary devices including a safety valve and air vent valve.

Connection to the under floor heating manifold or heating system is simple, using steel-reinforced flexible hoses.

Temperature regulation is controlled by the boiler's operating thermostat.

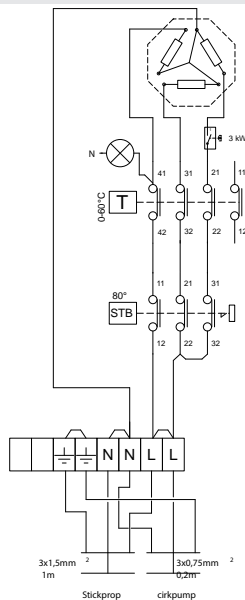

LK 440



CAPACITY DIAGRAM

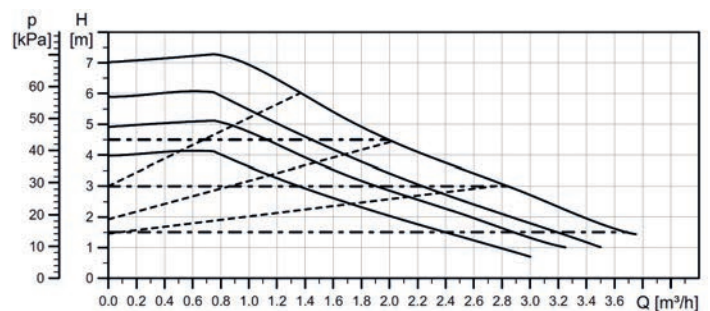

Article no.	Dim.	Connection	Voltage	B mm	H mm	L mm	Safety thermostat	Weight kg
298470	F 1"	3-phase 400 V Boiler must be protected using 3x16 A fuses (max. current 13.5 A)	9 kW in two stages at 4.5 kW	430	650	710	80 °C	30
298588	F 1"	1-phase 230V Boiler must be protected using 8,5 A 2 kW, 13 A 3 kW	2 alt. 3 kW	430	650	710	80 °C	30

LK 460 EasyHeat



TECHNICAL DATA

Voltage	400 V 3N~50Hz
Working temperature	9 kW: 0-60°C 22 & 42 kW: 20-95 °C
Media	Water - Glycol mixture max. 30%
Circulating pumps	Grundfos UPM3 AUTO L 15-50
Protection class	IP 44
Efficiency	9 kW, 22 kW, 42 kW
Current	9 kW: 16 A 22 kW: 32 A 42 kW: 63 A
Fuse	9 kW: 3x16 A 22 kW: 3x32 A 42 kW: 3x63 A
Connection	Claw coupling (or 1"/R25 M)
Operating thermostat	Max 60°C
Safety thermostat	80 °C
Expansion tank	10 l
Safety valve	9 kW: 1.5 bar 22 & 42 kW: 3 bar
Boiler volume	9 kW: 2 l 22 & 42 kW: 18 l

The LK 460 EasyHeat is a complete portable electrically heated boiler. It is primarily meant to be used as a temporary heater, e.g. for drying concrete slabs installed with under floor heating and for heating buildings under construction installed with a under floor heating system. The boiler can also replace the existing heat source in the event of a breakdown.

The boiler is available in several versions, equipped with a total output capacity of 2x4.5 kW (9kW) and 22kW / 42 kW. The output capacity is provided in different settings to provide a high comfort, efficient economy and a long-life span for the heating elements within the boiler.

The 22/42 kW versions can if required be reduced to 15 kw 24 kW output respectively. This provides a high comfort, efficient economy and a longer lifetime for the heating elements.

The boiler is supplied complete with a circulation pump, an expansion tank, auxiliary devices including a safety valve, air-bleed valve and a temperature adjuster. The cabinet is equipped with a lock and manufactured in galvanised steel. The lid is operated with shock absorbers.

Connection to manifold/heating system is simple, using steel-reinforced flexible hoses.

Temperature regulation is controlled by the boiler's operating thermostat.

Please note! 22 kW 42 kW is not released yet.

CAPACITY DIAGRAM

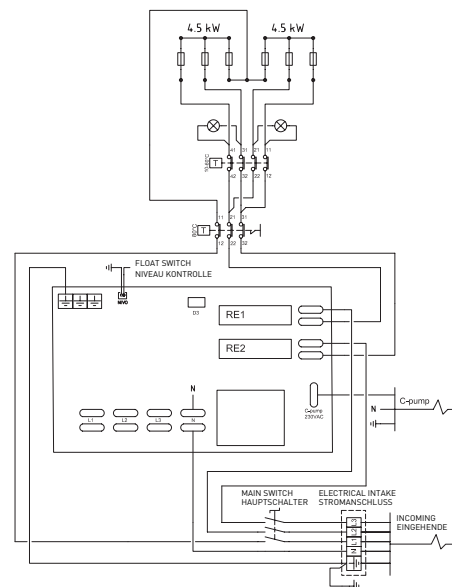
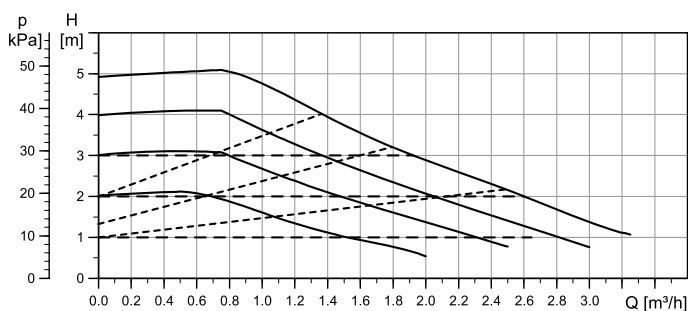

LK 460 - 9 kW

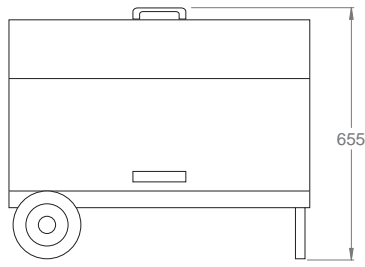

Article no.	Dimension	Voltage	B mm	H mm	L mm	Weight kg
299142	9 kW	9 kW in two stages at 4.5 kW	788	402	655	30

Other products



LK 315 Ball Valve
Ball valve for heating systems.



LK MultiConnection
Fittings for easy installation



LK 519 ThermoSafe
Thermal safety valve.



Prefabricated pipes



LK 522 FilterBall
Ball valve with an integrated filter.

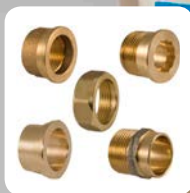

Transition Fittings



LK 700/705 AeroMat
Automatic float vent valves.

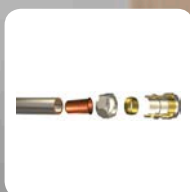

Assembly Instructions for
Compression Fittings / Media



LK 924 / 925 SafetyGroup
Safety group containing manifold,
manometer, safety valve and an air vent.



LK 315 BallValve



TECHNICAL DATA

Working temperature	Min. -20/Max. 110 °C
Max. working pressure	1.0 MPa (10 bar)
Media 1	Water - Glycol mixture max. 50%
Media 2	Water - Glycol/Ethanol mixture max 30%
Thread standard	Rp - female thread, G - male thread
Material, valve body	Brass EN 12165 CW617N
Material, sealing	PTFE
Spindle sealing	EPDM

Ballvalve for heating systems. The valve has a 2" rotating nut on one side, for an easy connection on e.g. a circulating pump. A sensor pocket is integrated in the valve body. Thermometer 181736 is available as an accessory.

LK 315 - Female thread

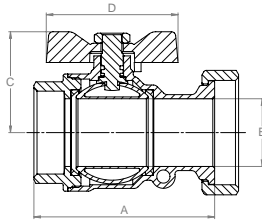

Article no.	Dimension	A mm	B mm	C mm	D mm	Weight kg
055840	F 2", rotating nut / F 1½"	98,5	37	55,5	72	0.9

LK 315 - Female thread / Male thread

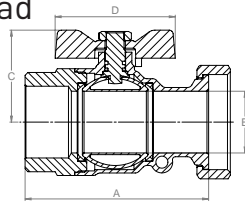

Article no.	Dimension	A mm	B mm	C mm	D mm	Weight kg
055841	F 2", rotating nut / M 2"	110	37	55,5	72	1.2

LK 315 - Female thread

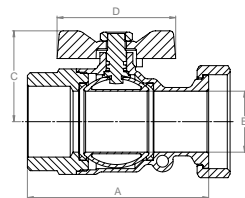

Article no.	Dimension	A mm	B mm	C mm	D mm	Weight kg
055842	F 2", rotating nut / F 2"	101,5	37	55,5	72	1.0

SPARE PARTS AND ACCESSORIES

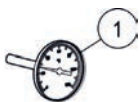

Article no.	Article	Position
181736	Thermometer 120 °C	1

LK 519 ThermoSafe



TECHNICAL DATA

Opening temperature	97±2 °C
Working temperature	Min. 5 °C/Max. 110 °C
Max. working pressure	1.0 MPa (10 bar)
Thread standard	Rp - female thread, G - male thread
Max. discharge capacity	6,5 m³/h at 0,6 MPa (6 bar)
Material, valve body	Brass EN 12165 CW617N
Material, spring:	Stainless steel
Material, capillary pipe:	Copper, length 1300 mm, with insulation
Material, sealing	Viton



LK 519 ThermoSafe is a thermal safety valve for solid fuel boilers with built-in water heaters or cooling coils. The safety valve prevents the temperature of the boiler water from rising above the boiling point. When temperature levels are too high the valve opens to let cold water flow through water heater or cooling coil, thus reducing the temperature of the boiler. LK 519 ThermoSafe has two, separately functioning, temperature sensors for added safety.

LK 519 ThermoSafe safety valve is installed on the outlet pipe of water heaters. The inlet pipe is recommended for cooling coils as such an installation would protect the armature from impurities caused by lime scale and other deposits. The arrow on the valve housing indicates the direction of the flow. The sensor pocket is screwed into the designated connection on the boiler. It is easier to install if the sensors are first removed from the pocket.

VALVE CHARACTERISTICS

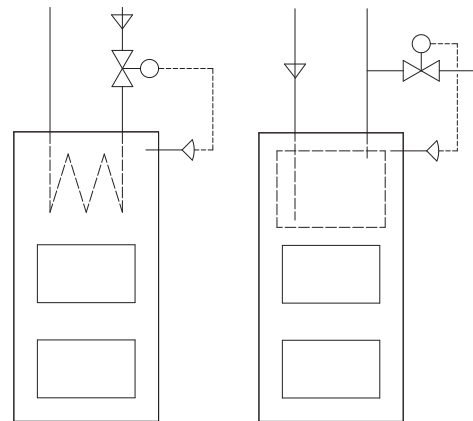
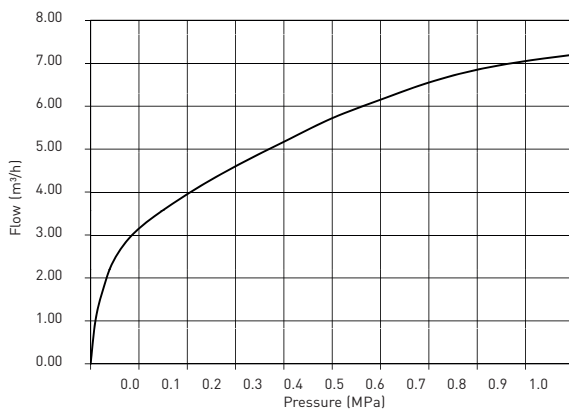

LK 519 - Female thread

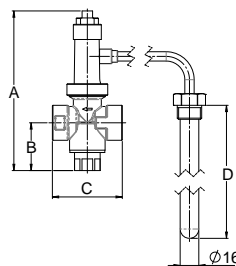

Article no.	Dimension	A mm	B mm	C mm	D mm	Weight kg
091777	F ¾" / M ½"	137	41	60	142	0.7

LK 522 FilterBall



TECHNICAL DATA

Working temperature	Min. -20 °C/Max. 120 °C
Max. working pressure	1.6 MPa (16 bar)
Media	Water - Glycol mixture max. 50%
Thread standard	Rp - female thread
Mash opening, filter	0.7 mm
Material, valve body	DZR Brass EN 12165 CW625N
Material, filter element	Stainless Steel
Material, cover sealing	EPDM
Material, sealing	PTFE
Spindle sealing	Two O-rings, EPDM

LK 522 FilterBall is a ball valve with an integrated filter suitable for heating, cooling and tap water systems.

The filter is easy to clean, just close the ball valve, unscrew the lid and remove the filter.

The valve requires no maintenance, but the installation should still be checked regularly.

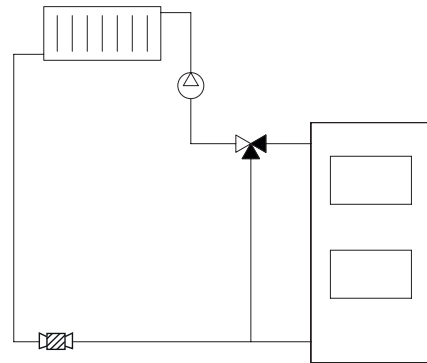
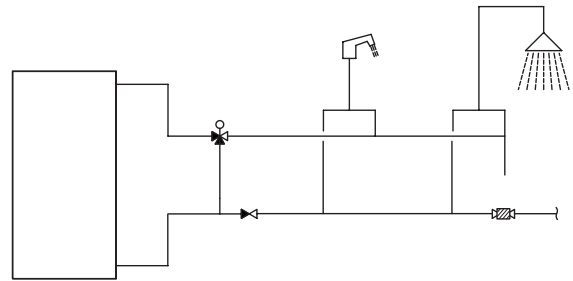

CAPACITY DIAGRAM

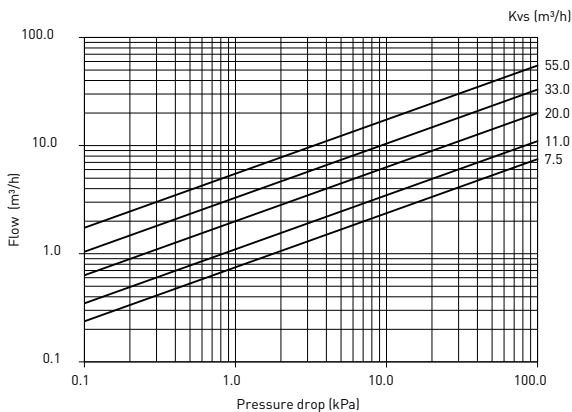

LK 522 - Female thread

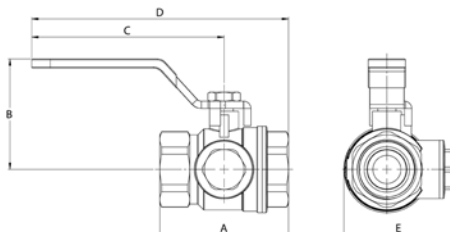

Article no.	Dimension	Kvs m ³ /h	A mm	B mm	C mm	D mm	E mm	Weight kg
182015	F ¾"	7.5	60	55	87	117	51	0.3
182016	F 1"	11	71	60	107	142	61	0.5
182017	F 1¼"	20	84	65	107	149	75	0.9
182018	F 1½"	33	93	80	143	189	88	1.3
182019	F 2"	55	119	90	143	203	105	2.1

LK 700/705 AeroMat



TECHNICAL DATA

Working temperature	Min. 5 °C/Max. 130 °C
Max. working pressure	1.6 MPa (16 bar)
Media	Water - Glycol/Ethanol mixture max. 50%
Thread standard	G - male thread, G - female thread
Material, valve body	Stainless Steel EN 10088 1.4301
Material, ball valve	Brass EN 12165 CW617N, externally sand- blasted and nickel-plated. Chrome ball
Material, sealing	PTFE

LK 700 and 705 AeroMat are automatic free floating air vent valves suitable for heating and cooling systems where pressure, temperature or media place high performance demands on the air vent valve.

The float vent valve is mounted vertically at a high point in the system. The shut-off valve is to be installed first and thereafter the float vent valve. The system should be flushed through and pressurized before mounting the float vent and opening the shut-off valve. Threads towards the system and the float vent are sealed in the usual manner.

The installation should be checked regularly. Sediments around the air outlet show that the float vent needs to be cleaned.

CHARACTERISTICS

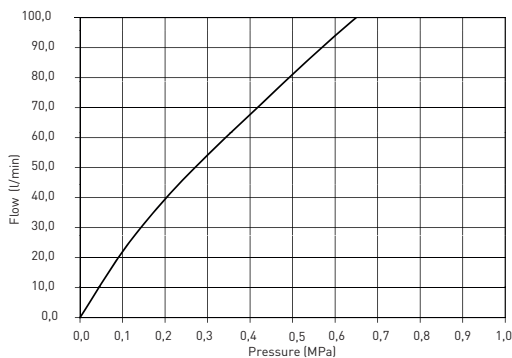

CLEANING THE FLOAT VENT VALVE

Close the shut-off valve and dismantle the float vent. Remove the black protective cap over the air outlet and unscrew the threaded union part underneath. Check that the outlet is free from impurities. If needed, clean with compressed air or cleaning needle. Clean the float vent by flushing it through with hot water from the top so that any impurities and sediments are removed. Reassemble the float vent valve in the reverse order.

LK 700 - Male thread

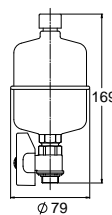

Article no.	Dimension	Note	Weight kg
094107	M 3/8"	without shut-off valve	0.4
4845228	M 3/8"	with shut-off valve	0.5

LK 705 - Female thread

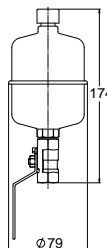

Article no.	Dimension	Note	Weight kg
4845244	F 3/8"	with shut-off valve	0.5

LK 924 / 925 SafetyGroup



TECHNICAL DATA

Working temperature	Min 5 °C/Max 110 °C
Ambient temp.	Min 5 °C/Max 60 °C
Max. working pressure	See the table below
Thread standard	Rp - female thread, G - male thread
Material, valve body	Brass EN 12165 CW617N

LK 924 / 925 SafetyGroup is a safety group for heating systems. The safety group contains manifold, manometer, safety valve and an air vent.

924 SafetyGroup has an automatic air vent with a float and 925 SafetyGroup has an automatic air vent with fibre discs. The manifold has two 1/2" connections for safety valve and for example an expansion vessel, one 3/8" connection for air vent.

The manometer shall be mounted in one of the three 1/4" connections, plug the other 1/4" connections with supplied plugs. Depending on model the manifold has a female 3/4" connection or a male 1" connection towards the heating system.

The manometer, air vent with a float and one 1/2" connection on the manifold are provided with a PTFE seal.

Safety valves in other pressure classes can be supplied upon request.

LK 924 - Female Thread

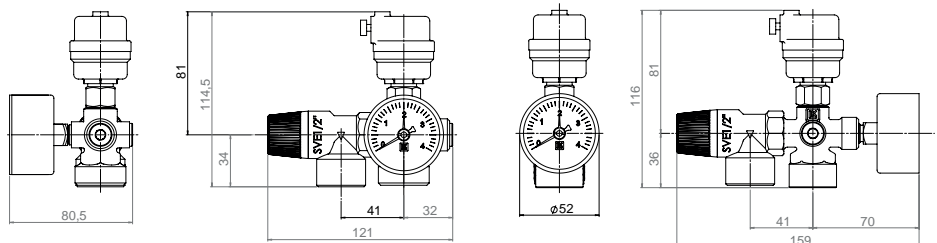

Article no.	Dimension	Opening pressure	Weight kg
092309	F 3/4"	0.3 MPa	0.6

LK 924 - Male thread

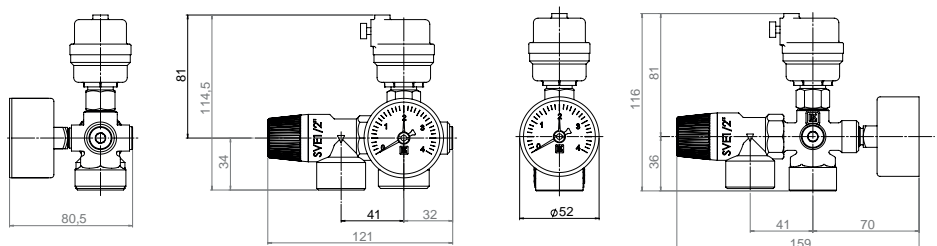

Article no.	Dimension	Opening pressure	Weight kg
092310	M 1"	0.3 MPa	0.6

LK 925 - Female thread

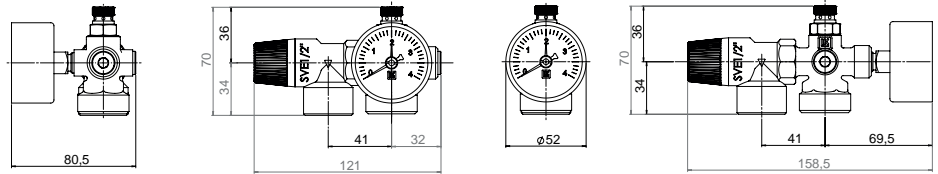

Article no.	Dimension	Opening pressure	Weight kg
092307	F 3/4"	0.3 MPa	0.5

LK 925 - Male thread

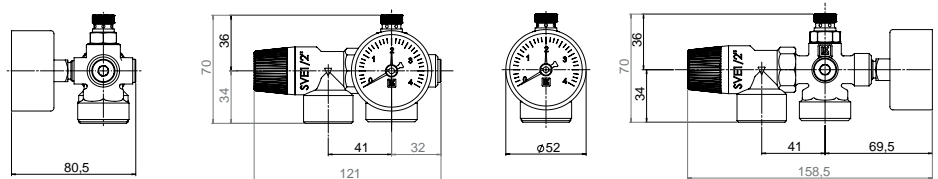

Article no.	Dimension	Opening pressure	Weight kg
092308	M 1"	0.3 MPa	0.5

SPARE PARTS AND ACCESSORIES

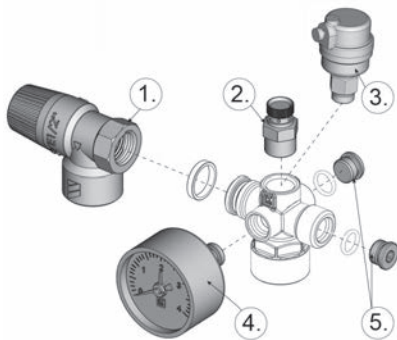

Article no.	Article	Position
055121	Safety relief valve 0,3 MPa	1
4842190	750 G10 Ventilating valve	2
094110	740-G10 Floating air vent	3
095279	Manometer 50-4 bar G 1/4"	4
070009	Plug 1/4"	5

LK MultiConnection



TECHNICAL DATA

Working temperature	Min -20 °C/Max 120 °C
Max. working pressure	1.6 MPa (16 bar)
Media	Water - Glycol mixture max. 50%
Thread standard	Rp - female thread, G - male thread
Material, valve body	DZR Brass EN 12165 CW625N

LK MultiConnections are a series of fittings for easy installation. Connections with fixed threads are designed for LK Armatur systems with O-ring seals (not M 1").

Flat surfaces are sealed with fibre gaskets.

See accessories for suitable fibre gaskets, below.

LK 931 - Male / Female / Rotating nut

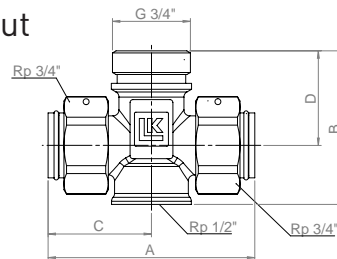

Article no.	Dimension	A mm	B mm	C mm	D mm	Weight kg
090090	M 3/4" x F 1/2" x F 3/4" rotating nuts x 2	70	52	35	32	0,2

LK 932 - Male / Rotating nut

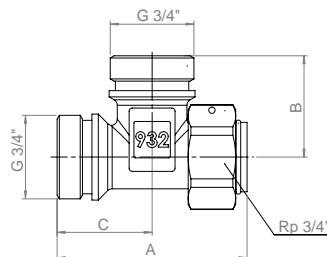

Article no.	Dimension	A mm	B mm	C mm	Weight kg
090091	M 3/4" x F 3/4" rotating nut	60	32	30	0,2

LK 933 - Male / Female / Rotating nut

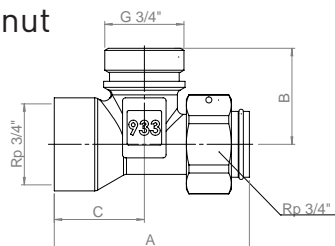

Article no.	Dimension	A mm	B mm	C mm	Weight kg
090092	M 3/4" x F 3/4" x F 3/4" rotating nut	65	32	30	0,2

LK 934 - Male / Rotating nut / Female

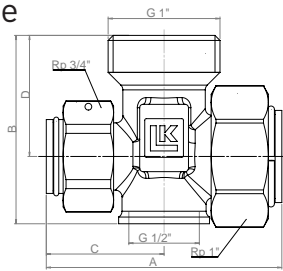

Article no.	Dimension	A mm	B mm	C mm	D mm	Weight kg
090256	M 1" x F 1/2" x (Rp 3/4" x Rp 1" rotating nuts)	70	56	35	36	0,2

LK 935 - Male / Rotating nut

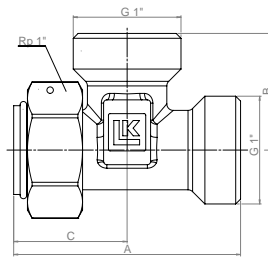

Article no.	Dimension	A mm	B mm	C mm	Weight kg
090257	M 1" x M 1" x F 1" rotating nut	70	36	35	0,2

LK 936 - Female / Male / Rotating nut

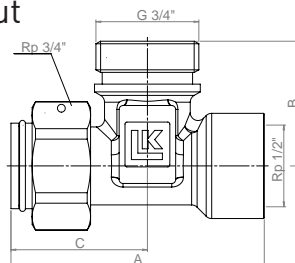

Article no.	Dimension	A mm	B mm	C mm	Weight kg
090258	F 1/2" x M 3/4" x F 3/4" rotating nut	65	32	35	0,2

LK 937 - Male / Rotating nut

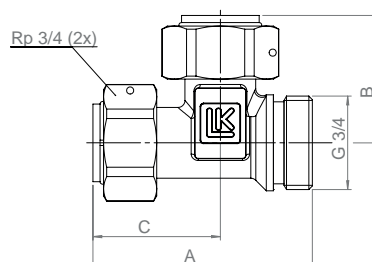

Article no.	Dimension	A mm	B mm	C mm	Weight kg
091707	M 3/4" x F 3/4" rotating nuts x 2	62	36	36	0,2

LK 938 - Male / Rotating nut

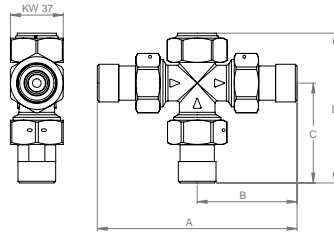

Article no.	Article	Dimension	A mm	B mm	C mm	D mm	Weight kg
092323	Fitting	M 1"	140	70	70	105	0,8

SPARE PARTS AND ACCESSORIES



Article no.	Article	Position
013035	Gasket C4400 1"	1
013032	Gasket C4400 3/4"	2
012018	O-ring for M 3/4"	3

Prefabricated pipes

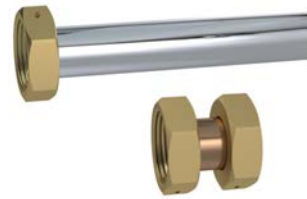

TECHNICAL DATA

Thread standard	Rp - female thread
Material 1	Stainless pipe
Material 2	Copper pipe

Flanged pipe - for use between flat sealing connection to compression/pressfitting etc.



Article no.	Dimension	Dimension 2	Length	Weight kg
299103	Pipe 15 mm	Rotating nut F 20	L=120 mm	0.09
299104	Pipe 18 mm	Rotating nut F 20	L=120 mm	0.09
299105	Pipe 22 mm	Rotating nut F 25	L=120 mm	0.12
299106	Pipe 28 mm	Rotating nut F 32	L=120 mm	0.17
299107	Pipe 28 mm	Rotating nut F 40	L=120 mm	0.22

Flanged pipe - for use between flat sealing connection to compression/pressfitting etc.



Article no.	Dimension	Dimension 2	Length	Weight kg
299187	Pipe 15 mm	Rotating nut F 20	L=120 mm	0.09
299188	Pipe 18 mm	Rotating nut F 20	L=120 mm	0.09
299189	Pipe 22 mm	Rotating nut F 25	L=120 mm	0.12
299190	Pipe 28 mm	Rotating nut F 32	L=120 mm	0.17
299191	Pipe 28 mm	Rotating nut F 40	L=120 mm	0.22

Flanged pipe - for use between flat sealing connection



Article no.	Dimension	Dimension 2	Length	Weight kg
298972	Pipe 22 x 1	Rotating nut F 25	L=21 mm	0.1
298992	Pipe 18 x 1	Rotating nut F 20	L=20 mm	0.08
298993	Pipe 28 x 1.2	Rotating nut F 32	L=20 mm	0.14
S180810	Pipe 35 x 1.5	Rotating nut F 40	L=30 mm	0.16

SPARE PARTS AND ACCESSORIES



Article no.	Article	Position
013012	Gasket Klingersil C4430 G20	1
013016	Gasket Klingersil C4430 G25	1
013010	Gasket Klingersil C4430 G32	1
013015	Gasket Klingersil C4430 G40	1

Transition Fittings



TECHNICAL DATA

Material, Union parts	Red brass, according to DIN 1705, ISO 1338
Material, Nuts	Brass
Material, Gaskets)	Aramid fibre (type KLINGERSil C-4400

Female thread / Rotating nut

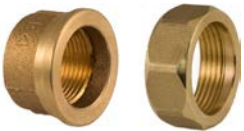

Article no.	Dimension	Dimension 2	A mm	Note	Weight kg
051039	F 3/8"	Rotating nut: M 3/4"	21	Art. no. Nut: 056093 Art. no. Sealing: 013032	0,03
051081	F 1/2"	Rotating nut: M 1"	22	Art. no. nut: 056082 Art. no. gasket: 013035	0,04
051082	F 3/4"	Rotating nut: M 1 1/4"	22	Art. no. nut: 051045 Art. no. gasket: 013010	0,07
051083	F 1"	Rotating nut M 1 1/2"	25	Article no. nut: 056023 Article no. gasket: 013038	0,09
051084	F 1 1/4"	Rotating nut: M 2"	29	Art. no. nut: 051064 Art. no. gasket: 013017	0,2
051085	F 1 1/2"	Rotating nut: M 2 1/4"	32	Art. no. nut: 051078 Art. no. gasket: 013033	0,2
051086	F 2"	Rotating nut: M 2 3/4"	34	Art. no. nut: 051079 Art. no. gasket: 013034	0,3

Male thread / Rotating nut

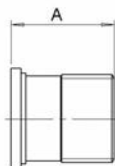

Article no.	Dimension	Dimension 2	A mm	Note	Weight kg
051019	F 1/2"	Rotating nut: M 3/4"	27	Art. no. Nut: 056093 Art. no. Sealing: 013032	0,04
051050	F 3/4"	Rotating nut: M 1"	31	Art. no. Nut: 056082 Art. no. Sealing: 013035	0,07
051051	F 1"	Rotating nut: M 1 1/4"	35	Art. no. Nut: 051045 Art. no. Sealing: 013010	0,1
051063	F 1 1/4"	Rotating nut: M 1 1/2"	39	Art. no. Nut: 051062 Art. no. Sealing: 013038	0,2
051072	F 1 1/2"	Rotating nut: M 2"	41	Art. no. Nut: 051064 Art. no. Sealing: 013017	0,2

Internal solder / Rotating nut



Article no.	Dimension	Dimension 2	A mm	Note	Weight kg
051015	15 mm	Rotating nut: M 3/4"	19	Art. no. Nut: 056093 Art. no. Sealing: 013032	0,02
051008	18 mm	Rotating nut: M 3/4"	17	Art. no. Nut: 056093 Art. no. Sealing: 013032	0,03
051101	18 mm	Rotating nut: M 1"	19	Art. no. Nut: 056087 Art. no. Sealing: 013062	0,04
051046	22 mm	Rotating nut: M 1"	19	Art. no. Nut: 056082 Art. no. Sealing: 013035	0,06
051047	28 mm	Rotating nut: M 1 1/4"	25	Art. no. Nut: 051045 Art. no. Sealing: 013010	0,08
051066	35 mm	Rotating nut: M 1 1/2"	27	Art. no. Nut: 056023 Art. no. Sealing: 013038	0,07
051067	42 mm	Rotating nut: M 2"	31	Art. no. Nut: 051064 Art. no. Sealing: 013017	0,2
051068	54 mm	Rotating nut: M 2 1/2"	37	Art. no. Nut: 051065 Art. no. Sealing: 013038	0,2

Internal solder / Male thread



Article no.	Dimension	A mm	Z mm	Weight kg
2008126	15 mm x F 3/8"	25	14	0,03
2008134	15 mm x F 1/2"	25	14	0,03
2008142	15 mm x F 3/4"	25	14	0,04
2008209	18 mm x F 1/2"	27	14	0,03
2008217	18 mm x F 3/4"	26	13	0,06
2008233	22 mm x F 1/2"	34	18	0,06
2008241	22 mm x F 3/4"	31	15	0,05
2008258	22 mm x F 1"	30	15	0,06
051095	28 mm x F 1/2"	41	22	0,1
2008282	28 mm x F 3/4"	41	22	0,1
2008290	28 mm x F 1"	36	17	0,1
2008308	28 mm x F 1 1/4"	36	17	0,1
2008324	35 mm x F 1"	47	24	0,1
2008332	35 mm x F 1 1/4"	43	20	0,1
051096	35 mm x F 1 1/2"	43	20	0,2
051097	42 mm x F 1 1/4"	51	24	0,2
2008381	42 mm x F 1 1/2"	48	21	0,2
051098	42 mm x F 2"	51	24	0,3
051099	54 mm x F 1 1/2"	61	29	0,3
2008423	54 mm x F 2"	58	26	0,3

Assembly Instructions for Compression Fittings

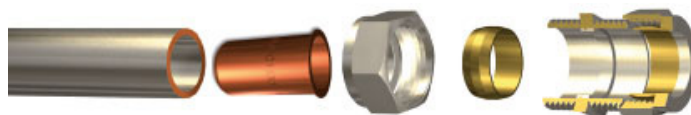

Compression fittings are produced in high quality brass. As any copper-based material, brass is potentially subject to stress corrosion cracking. When compression fittings are used in cooling systems, this risk for stress corrosion cracking may be higher than in heating applications. This is due to the development of moisture that can contain some amount of ammonia or its derivatives.

The following good-installation practice shall be used when installing compression fittings in cooling systems in order to eliminate or, at least, to minimize the risk for stress corrosion cracking:

- Lubricate the compression fitting before installation.
- Only use box spanners during installation.
- Tighten first by hand and then with a box spanner. Do not overtighten. Spanner tightening as per the table below.

- After the compression fitting is tightened, wrap it by using an "ammonia-free" impervious tape. This will protect the nut against moisture. Please, consider that certain insulation materials develop ammoniacal derivatives - contact the manufacturer of the insulation material when in doubt.

SOFT PIPES ARE TO BE FITTED WITH A SUPPORT SLEEVE.

- Soft copper and steel pipes = Use a type SC support sleeve
- PEX pipes = Use a type WP support sleeve.

FOR FITTING WITH REDUCTION 68:

First tighten the nut until the chamfer "fails" and a "crack" is heard. Then tighten the nut further until a light resistance is felt, plus number of turns as per the table value corresponding to the reduced dimension. The reduction is not intended to be used on PEX pipes.

TIGHTENING - NUMBER OF TURNS

Outer Diameter	Copper Pipe	Soft Steel Pipe	Stainless Steel Pipe	Plastic Pipe	Spanner Flat Width
8	1¼	¾	¾		16,0
10	1¼	¾	¾	2	18,3
12	1¼	¾	¾	2	20,5
15	1¼	¾	¾	1¼	24,5
16	1¼	¾	¾	1¼	25,6
18	1¼	¾	¾	1¼	27,6
22	1	¾	¾	1½	32,8
28	¾	¾	½	1½	39,2
35	¾	½	½		46,9
42	¾	½	½		55,0
54	¾	½	½		70,2

Media



The Kvs values read from the capacity diagrams in this product catalogue are valid when water is the medium. The addition of glycol affects the viscosity and the heat transfer coefficient

which should be taken into account when selecting valve dimension. For mixtures with 30-50% glycol a valve with the nearest higher Kvs value should be selected.

LK ARMATUR AB

Garnisonsgatan 49
SE-254 66 Helsingborg
Sweden

Phone: +46 (0)42-16 92 00

Fax: +46 (0)42-16 92 20

info@lkarmatur.se

order@lkarmatur.se

FOR THE SIMPLER, SMARTER EVERYDAY

Simpler. Smarter. More sustainable. At LK, we believe there's a better way to do everything. It's a belief all of us at LK apply to every product and solution we create – from water, heating and hydronic solutions to pipe extrusion.

LK Armatur is a leader in Europe, producing millions of valves per year for the global HVAC market. Beyond individual products, we understand how all parts interact in your complete application. From standard to sophisticated customizations of valves, controllers, components and prefabricated units, our full-spectrum expertise makes it easy to get the results you need today, while anticipating your needs tomorrow.



Cerbos

küttesüsteemid • müük • paigaldus • hooldus

tel +372 442 0222 / +372 434 1000 • www.cerbos.ee • info@cerbos.ee

www.lkarmatur.com