

FINAL USER'S INSTRUCTION MANUAL

pCO⁵/pGD DIGITAL CONTROLLER

HEAT PUMPS

AirMaster, AquaMaster, EasyMaster, BoxAir

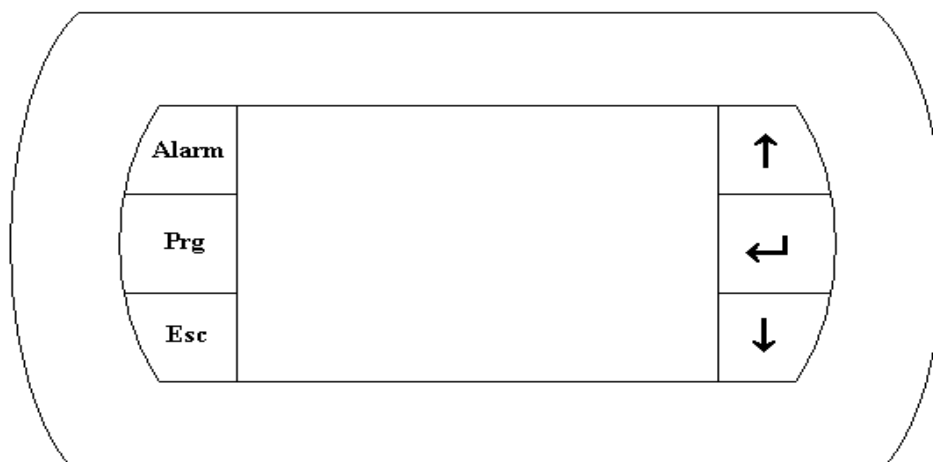

TABLE OF CONTENTS:

1	Introduction	4
2	Visual display unit	4
2.1	Display unit	4
2.2	Denotation and functions of keyboard keys and backlighting	4
2.3	Language Change	5
3	Structure of the menu	5
3.1	Main screen	5
3.1.1	Operating Mode.....	5
3.1.2	Compressor Operation	6
3.1.3	Pump Operation	6
3.1.4	Fan/Brine Pump Operation.....	6
3.1.5	Defrost Mode.....	6
3.1.6	Electric Heater Operation and Safety Thermostat Activated	7
3.1.7	Outdoor Temperature	7
3.1.8	Temperature of Water	7
3.1.9	Sanitary Hot Water Temperature.....	7
3.1.10	Room Temperature	7
3.1.11	Electricity Teariff / Remote Off	7
3.1.12	Unit On/Off	7
3.2	Auxiliary screens.....	8
3.2.1	Setting Unit Operation	8
3.2.2	Sanitary Hot Water	9
3.2.3	Heating/Cooling.....	12
3.2.4	Room Terminal pADxx	15
3.2.5	Heating Circuits	19
3.2.6	Solar.....	22
3.2.7	Swimming Pool.....	23
3.2.8	Service Info	24
3.2.9	Clock	25
4	Alarms.....	28
4.1	Types of alarm	28
4.2	General Alarm Explanation	29
4.3	Detailed Alarm Displays.....	29
4.4	Warnings.....	30
4.5	To reset alarms	31
4.6	Manual reset	31
5	What to do if.....	32
5.1	After power is on, the backlighting of the ALR key flashes	32
5.2	The main screen with icons shows the symbol flashing.....	32
5.3	The symbol is lit	32
5.4	The backlighting of the ALARM key flashes.....	32
5.5	The ALARM key is lit steadily	32
5.6	Active icon.....	32
5.7	Defrosting icon flashes.....	32
5.8	Defrosting icon is steadily lit.....	32
5.9	E! appears on the Main Screen.....	33
5.10	Pump symbol is flashing on the Main Screen	33

6	Switchboard	34
6.1	AirMaster, EasyMaster, AquaMaster	34
6.2	BoxAir	35
6.3	Main switch	36
6.4	Control circuit breaker	36
6.5	Control Circuit Fuses	36
6.6	Auxiliary Heater Safety Thermostat	36
6.7	Emergency Auxiliary Heater Manual Thermostat.....	36
6.8	Auxiliary Heater Circuit Breaker	36
6.9	Compressor circuit breaker	36
7	Troubleshooting	37
7.1	Water/Water, Brine/Water Heat Pumps	37
7.2	Air/Water Heat Pumps	39
7.3	Reseting Circuit Breakers	41
7.4	Reseting the Auxiliary Heater Safety Thermostat	41
7.5	Defrost Cycle (Air/Water only).....	41
7.5.1	Activating of the Manual Defrost.....	41
8	Declaration of Conformity	42
9	Safety and Environment Protection.....	44
9.1	Greenhouse Gas.....	44
9.2	Hermetical Sealing.....	44
10	Energy Labeling	44
11	Dismantling & Disposal	44

1 Introduction

The pCO⁵ electronic controller with the PGD visual display unit is a programmable controller, enabling to control heat pumps.

The product range of heat pumps delivered by Master Therm CZ includes the controllers integrated in AIRMASTER, EASYMASTER, BOXAIR air/water heat pumps and AQUAMASTER water/water heat pumps.

2 Visual display unit

The communication with the regulator is made possible by the visual display unit with graphic display, keyboard, and indicators. It is possible to use the keyboard to take basic control of the heat pump such as:

- Setting the mode of operation
- Solving emergency states
- Checking the state of the heat pump (indication of operation, operating temperature)

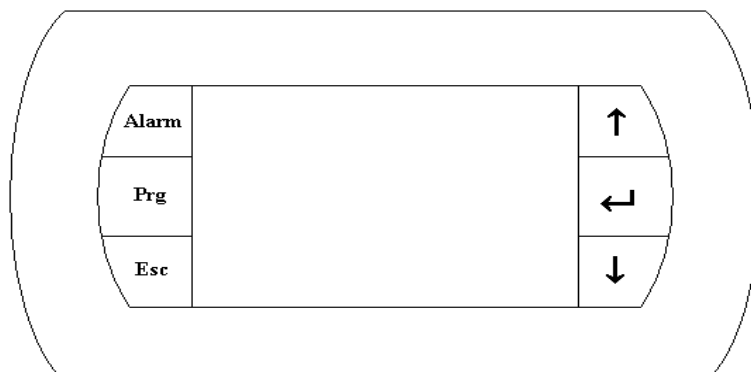

2.1 Display unit

It is the graphic display unit with the resolution of 132x64 pixels. The unit displays operating and configuration parameters.

2.2 Denotation and functions of keyboard keys and backlighting

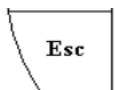

ESC key

- Is used for escaping from a menu or for jumping one level higher in the menu
- Backlighting indicates that the device is under voltage.

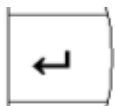

ENT key

- Is used for saving entered parameters and for jumping to another variable indicated on the screen
- Backlighting indicates that the device is under voltage.



ALARM key

- A short press is designed for entering the alarm displayed
- If backlighting flashes on and off, an alarm is active
- If backlighting is lit steadily, the manual alarm reset is necessary (the same error 3x per hour).

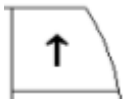

UP key

Moves the cursor up, lists in the menu, increments the parameter value
 - It starts the manual defrosting along with the DOWN key.

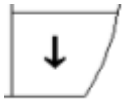

DOWN key

- Moves the cursor down, lists in the menu, decrements the parameter value
 - It starts the manual defrosting along with the UP key.

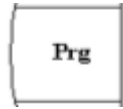

PRG key

- Is used for entering the detailed menu of the controller from the initial display
 - Is used for entering the menu to set up heating circuits (optional)
 - calls in Help in some screens.

2.3 Language Change

Pressing keys ESC and ENTER simultaneously will change to the next available language.

3 Structure of the menu

3.1 Main screen

This screen is automatically activated after turning the main switch on. The main screen is also automatically activated after escaping from the detail menu of the control unit (ESC key).

The main screen indicates the operating condition of the unit. The following icons are displayed in the main screen:

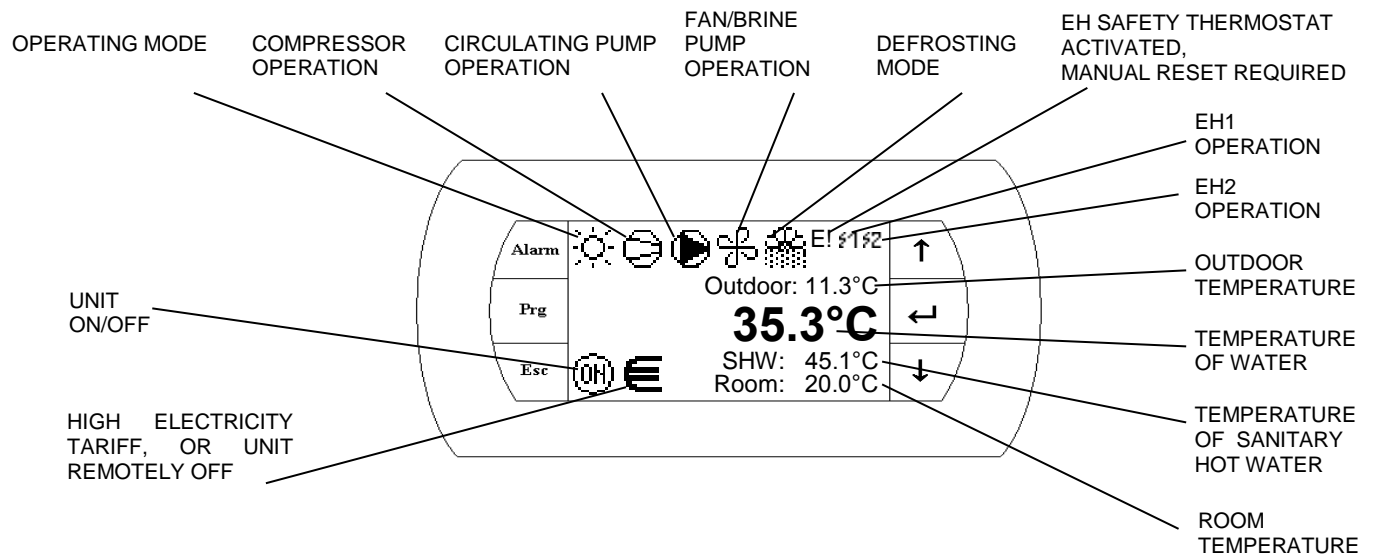

3.1.1 Operating Mode

Following operating modes are possible:



Heating



Heating – low outdoor temperature (aux. heaters only, compressor OFF)



Cooling, or Passive Cooling (GSHP only)



Cooling with Dew Point protection (no humidity condensation possible)

 Sanitary Hot Water preparation active

 Swimming Pool heating active

—When icon is FLASHING, unit is in the SUMMER MODE.

3.1.2 Compressor Operation

Following compressor indicators are possible:

 Compressor no. 1 in operation

 Compressor no. 2 in operation (2 compressor units only)

 Compressors 1 and 2 in operation (2 compressor units only)

 Recommended Unit Service Inspection

This situation is NOT ALARM and unit continues in normal operation.

After typical compressor time in operation, it is recommended refrigerant circuit service inspection. Typical time is 3000 operating hours, therefore we recommend service inspection in 6 months from service icon appearing.

3.1.3 Pump Operation

Following circulating pump indicators are possible:

 Heating Circulating Pump in operation

—When icon is flashing more than 10s after the circulating pump start, the flow did not start and pump was switched off to protect it from damaging. This situation is called “Pump Alarm”. System tries to restart the pump each compressor off time. This situation is usually connected to “Flow Alarm”, please see the “Alarms” chapter.

3.1.4 Fan/Brine Pump Operation

Following Fan (Air to Water), or Brine Pump (GSHP) indicators are possible

 Fan/Brine Pump in operation

3.1.5 Defrost Mode

Defrost status indication for Air/Water heat pumps.

—Flashing Icon indicates Temperature Condition for Defrost Mode, but minimum time from last defrost cycle has not elapsed

—Permanent Icon indicates Active Defrost Mode.

**During Defrost Mode “Steam/Fog” can appear in the area of outdoor unit.
This is standard behaviour.**

3.1.6 Electric Heater Operation and Safety Thermostat Activated

When the Electric (Auxiliary) Heater Safety Thermostat is activated the icon “E!” will appear on the main screen.

This situation could happen by the overheating of the electric heater, caused by insufficient water pressure in the heating system, or by heating circulation pump malfunction. This problem is also related “FLOW” Alarm.

When this situation occurs, it is necessary to manually reset the Safety Thermostat. Please see the “Troubleshooting” chapter for Safety Thermostat location and reset procedure.

 Heater no 1 in operation

 Heater no 2 in operation

When Icons are **FLASHING**, the system is requesting heater operation, but due to Safety Thermostat activation or “Pump Alarm” heater could not be started. Please reset the Safety Thermostat or fill the water to the heating system.

3.1.7 Outdoor Temperature

The real outdoor temperature is shown on the display in °C.

3.1.8 Temperature of Water

Actual heating water temperature is shown on the display in °C.

3.1.9 Sanitary Hot Water Temperature

When the Heat Pump is configured for preparing of Sanitary Hot Water, the display is showing actual Sanitary Hot Water temperature.

3.1.10 Room Temperature

When the Room Temperature Probe is used, it is shown on the main display.

When Room Terminal (pAD) is used, the temperature is not shown on the main display. In case pAD Room Terminal or, more pADs are used, please see the pAD menu (list using arrow down).

3.1.11 Electricity Tariff / Remote Off

Following situations are possible:

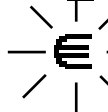
-  High Electricity Tariff is active (where applicable), or unit is Remotely OFF
-  Flashing symbol indicates High Electricity Tariff or Remote OFF, but Compressor operation is configured to ignore the command.

3.1.12 Unit On/Off

Following operators are possible:

 Unit is ON

 Unit is OFF

3.2 Auxiliary screens

Auxiliary screens can be displayed by pressing the UP or DOWN keys. After the last screen has been displayed, the main screen with icons will be automatically reached when the UP or DOWN keys are pressed.

By pressing the ESC key in any of the auxiliary screens, the main screen with icons will be automatically reached.

Pressing PRG key will cause entering “deeper” menu, enabling more detailed setting.

3.2.1 Setting Unit Operation

This screen indicates the ON/OFF state, HEATING/COOLING function and AUTO/SUMMER/WINTER mode. This screen enables to change the operating mode of the heat pump.

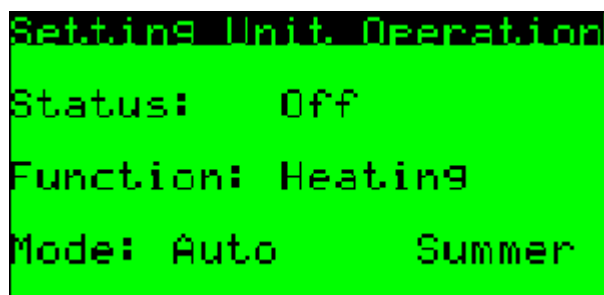

By pressing the ENT key, the cursor moves to a variable that can then be edited with UP and DOWN keys – to change its value. After you have entered a desirable value, it is necessary to confirm it by pressing the ENT key, making the cursor move to another variable. After the last variable on the screen has been edited, the cursor returns to the top left corner of the screen. After that you can use the UP or DOWN keys to move to previous or next screens.

In this case, the unit can be switched from ON to OFF and vice versa, it is possible to change the function of the heat pump into HEATING or COOLING and change the operating mode to AUTO, WINTER, OR SUMMER. The function HEATING/COOLING can only be changed if the state "Status = OFF".

Parameters Setting:

Parameter:	Range:	Unit	Description
Status	On Off	-	On: unit is ON. Off: unit is OFF.
Function	Auto Heating Cooling*	-	Auto: Function is automatically selected according to the Mode setting. Heating: All heating circuits are in operation. Cooling: All cooling circuits are in operation. Heating is disabled with exception of the Sanitary Hot Water and Swimming Pool. Mode is forced to Summer.
Mode	Auto Winter Summer	-	Auto: Mode is automatically selected according to the outdoor temperature. Winter: All heating circuits are in operation. Cooling is disabled. Summer: Heating is disabled with exception of the Sanitary Hot Water and Swimming Pool.

* Cooling is available only for Reversible Heat Pump or GSHP with Passive Cooling Module.

3.2.1.1 Setting Automatic Changeover

Pressing PRG key from previous screen displays mask with automatic changeover.

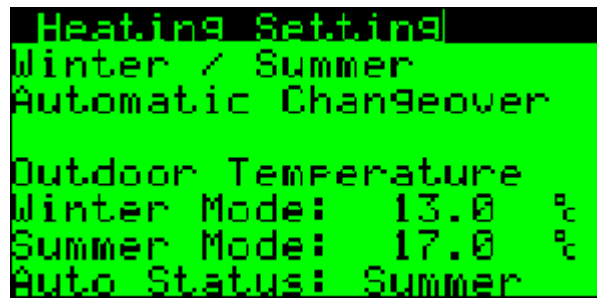

Parameters Setting:

Parameter:	Range/F.:	Unit	Description
Winter Mode	-20.0 40.0 F:+13.0	°C	Outdoor temperature for activation of Winter Mode. Below this temperature, Winter Mode is activated.
Summer Mode	-20.0 40.0 F:+17.0	°C	Outdoor temperature for activation of Summer Mode. Above this temperature, Summer Mode is activated.
Auto Status	Winter Summer	-	Result of the Automatic Changeover according to the setting above.

Note: The mode is not changed according to actual outdoor temperature, but rather the “average” outdoor temperature, created inside the controller.

Pressing ESC key, the previous “Setting Unit Operation” screen is displayed.

3.2.2 Sanitary Hot Water

The next auxiliary screen is the Sanitary Hot Water (SHW) main display. This screen is available, when heat pump is configured to prepare SHW.

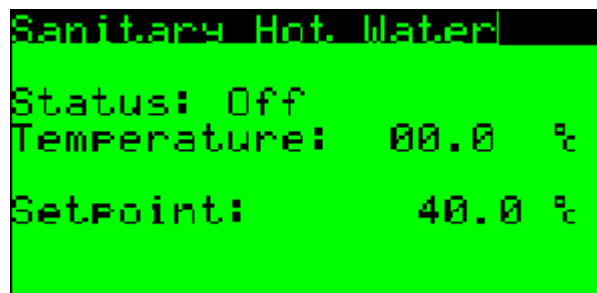

Parameter:	Range/F.:	Unit	Description
Status	On Off	-	On: SHW function is activated. Off: SHW function is not activated.
Temperature	-	°C	Actual SHW temperature..
Setpoint	0 45(60*)	°C	Requested SHW temperature set by user.

* When setpoint is higher than 45°C, it is possible, the electric heater will be activated to reach the requested temperature.

3.2.2.1 Antibacteria (Legionella) Function

Using PRG from previous screen, the Antilegionella setting screen is shown. Legionella is bacteria, generally present in tap cold water in small quantity. Small quantity is not dangerous for humans. When tap water temperature is in range between 25°C to 35°C, the Legionella bacteria is reproducing exponentially. When this temperature range is maintained for long period of time, the quantity of bacteria in some cases could reach level dangerous for humans in case of inhalation. This could happen an example during showering. Legionella could cause disease similar to pneumonia. Although the risk for healthy human is very low, it is dangerous for humans with decreased immunity.

From reasons listed above, we recommend to keep the SHW setpoint around 45°C (not lower than 40°C), when bacterial growth is 0 or very low.

Anyway it is possible to enable “Antilegionella” function. When function is enabled, the SHW setpoint is weekly automatically increased and maintained for programmed period of time. Sufficient is the temperature 60°C, that kills all Legionella bacteria present in the water in a few minutes.

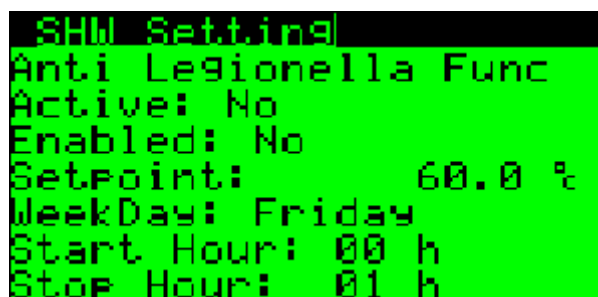

Parameter:	Range/F.:	Unit	Description
Active	No Yes	-	Showing the antibacterial function is actually in operation.
Enabled	No Yes F: No	-	Enabling the function. No: Function is not enabled. Yes: Function is enabled.
Setpoint	0 65*	°C	Requested SHW temperature set for Antilegionella function by user.
WeekDay	Mo-Su F: Friday	-	Day of the week for function activation.
Start Hour	0-23 F: 0	h	Start hour of the increased SHW setpoint.
Stop Hour	0-23 F: 2	h	Stop hour of the increased SHW setpoint. We recommend 1 hour of time for each 100 l of the SHW tank volume. Example: SHW tank volume is up to 200 l . We recommend 2 hour period. SHW tank volume is 300 l . We recommend 3 hour period.

* Cause the setpoint is higher than 45°C, it is possible, the electric heater will be activated to reach the requested temperature.

Note: For correct function, the heat pump must be equipped with internal or external electric heater or gas boiler.

Using ESC key returns to the Main SHW display. Using UP/DOWN keys lists in SHW menu.

3.2.2.2 Solar Period function

Function to block SHW preparation by the heat pump according to simple timer setting.

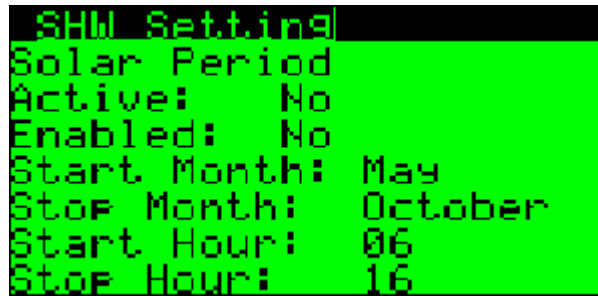

Parameter:	Range/F.:	Unit	Description
Active	Yes No	-	Yes: unit is in Solar Period No: unit is in normal mode
Enabled	Yes No	-	Yes: function is enabled No: function os disabled
Start Month	Jan-Dec	-	Month to start function
Stop Month	Jan-Dec	-	Month to stop function
Start Hour	00-23	h	Hour of the day to start function
Stop Hour	00-23	h	Hour of the day to stop function

Simply set the timer to block SHW preparation to allow solar thermal energy heat up the SHW.

Using ESC key returns to the Main SHW display. Using UP/DOWN keys lists in SHW menu.

3.2.3 Heating/Cooling

This display informs about the main heat pump heating/cooling circuit status and enables the Automatic or Manual circuit operation.

```

Heating/Cooling
Room Temperature
Requested:      20.000 °C
Actual:        00.0 °C
Water Temperature
Requested 00.0 /00.0 °C
Actual:       36.0 °C
Mode: Auto    00.0
  
```

Parameter:	Range/F.:	Unit	Description
Room Temperature Requested	6.0 32.0 F: 20.0	°C	Requested Room temperature set by user. When Room probe is not used, this value is considered to adjust the water temperature. When pAD room terminal is used, entered value is automatically transferred to the pAD and vice versa.
Room Temperature Actual	-99.9 99.9	°C	If room temperature probe is used or pAD room terminal is used, this value is showing the real room temperature (Main Zone)
Water Temperature Requested	-99.9 99.9	°C	xx.x: The first value is the requested temperature according to the weather compensation setting of the main heating/cooling circuit. /xx.x: The second value is the result of all requests from the other heating/cooling circuits and exactly the real requested setpoint for Heat Pump.
Water Temperature Actual	-99.9 99.9	°C	Actual heating/cooling water temperature.
Mode	Auto Manual F: Auto	-	Auto: Automatic operation according to the setting of the main weather compensation curve. Manual: Manual operation according to entered value.
Manual Requested Temperature	*-99.9 99.9	°C	Requested heating/cooling water temperature set by user.

* The real temperature range is limited according to the setting during commissioning.

3.2.3.1 Heating Setting

Pressing PRG from previous screen will show Main Heating Weather Compensation Setting display.

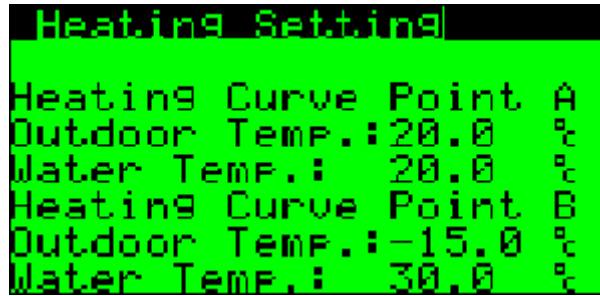

Weather compensation parameters could be shown on following picture:

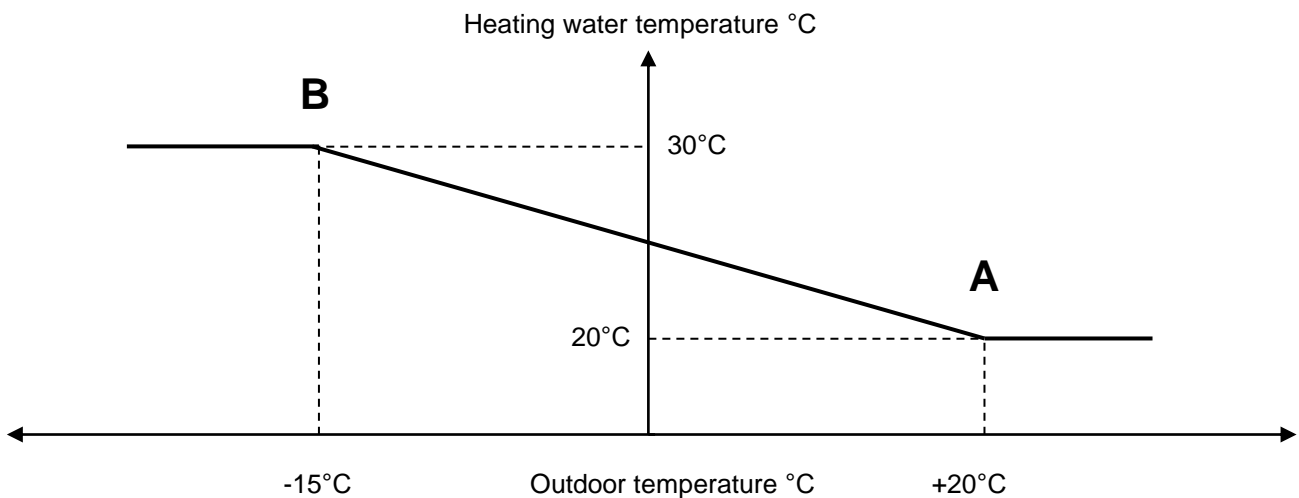

Parameter:	Range/F.:	Unit	Description
Point A Outdoor Temperature	-20.0 30.0 F: 20.0	°C	Point A, outdoor temperature definition.
Point A Water Temperature	*20.0 47.5 F: 20.0	°C	Point A, water temperature definition. Requested heating water temperature for defined Point A outdoor temperature. 20.0°C is typical setting for Under Floor Heating (UFH) and Radiators.
Point B Outdoor Temperature	-20.0 30.0 F: -15.0	°C	Point B, outdoor temperature definition.
Point B Water Temperature	*20.0 47.5 F: 30.0	°C	Point B, water temperature definition. Requested heating water temperature for defined Point B outdoor temperature. 30.0°C is typical setting for UFH. 40.0°C is typical setting for Radiators.

* The real temperature range is limited according to the setting during commissioning.

Use ESC key for return to previous display.

Use UP or DOWN key to reach the "Cooling Setting", for units with Cooling, or Passive Cooling only.

3.2.3.2 Cooling Setting

This display is available only for units with Cooling, or Passive Cooling (Optional Equipment). Display enables setting of the Main Cooling Weather Compensation.

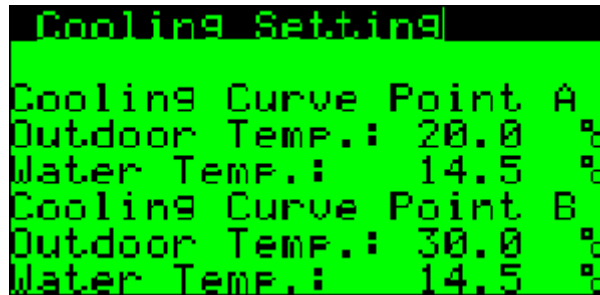

Weather compensation parameters could be shown on following picture:

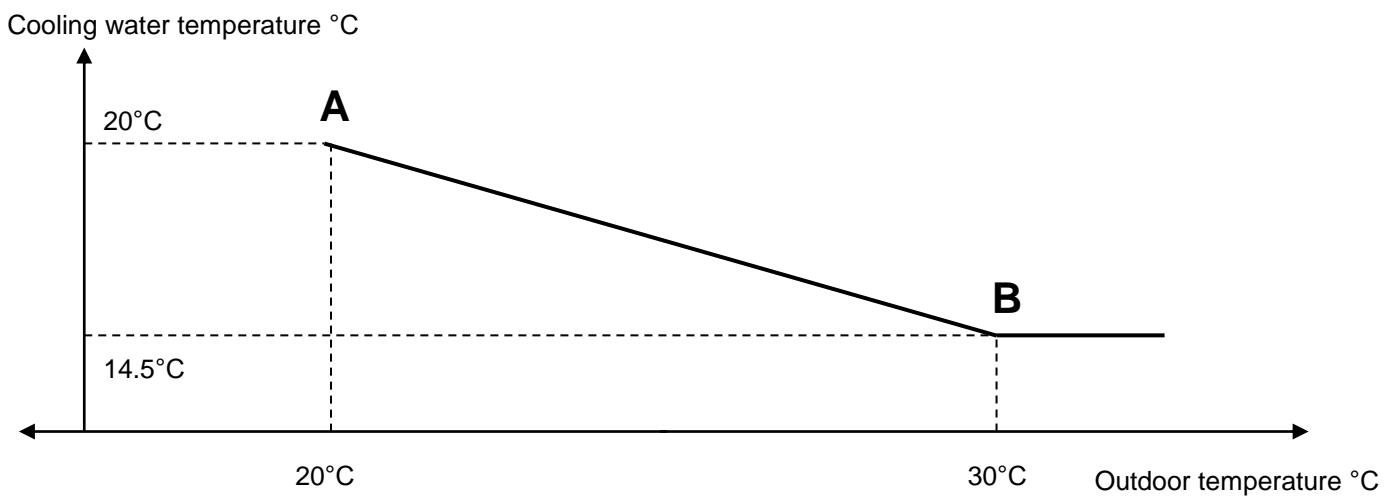

Parameter:	Range/F.:	Unit	Description
Point A Outdoor Temperature	10.0 40.0 F: 20.0	°C	Point A, outdoor temperature definition.
Point A Water Temperature	*14.5 30.0 F: 14.5	°C	Point A, water temperature definition. Requested cooling water temperature for defined Point A outdoor temperature. 20.0°C is typical setting for Under Floor Heating (UFH) and FanCoils.
Point B Outdoor Temperature	10.0 40.0 F: 30.0	°C	Point B, outdoor temperature definition.
Point B Water Temperature	*14.5 30.0 F: 14.5	°C	Point B, water temperature definition. Requested cooling water temperature for defined Point B outdoor temperature. 18.0°C is typical setting for UFH. 14.5°C is typical setting for FanCoils.

* The real temperature range is limited according to the setting during commissioning. Additional limitation is possible due to the Dew Point protection if it is activated.

Use ESC key for return to the display Heating/Cooling.

3.2.4 Room Terminal pADxx

When pAD room terminal is installed, following display automatically appears in the menu.

```

pAD 01 Room Terminal
On/Off: PERMANENT OFF
Mode: None
Setpoint: 00.0°C
Temperature: 00.0°C
Rel.Humidity: 000 %
  
```

Parameter could be adjusted directly on pAD room terminal or remotely on pGD display using this mask.

Parameter:	Range/F.:	Unit	Description
pAD	01, 11-16	-	pAD Identification Number. This Parameter is not adjustable. It is given by pAD Hardware Address. 01: Main Zone Room Terminal 11: Heating Circuit 1 Room Terminal 12: Heating Circuit 2 Room Terminal 13: Heating Circuit 3 Room Terminal 14: Heating Circuit 4 Room Terminal 15: Heating Circuit 5 Room Terminal 16: Heating Circuit 6 Room Terminal
On/Off	Permanent OFF OFF ON	-	Permanent OFF: Terminal is permanently OFF and heating/cooling of the zone is disabled. OFF: Terminal is OFF by the scheduler and heating/cooling of the zone is temporarily disabled. ON: Terminal is ON and heating/cooling of the zone is enabled.
Mode	Winter Summer	-	For pAD 01 it has the same meaning like the main Mode of the Heat Pump. When unit is equipped with cooling or passive cooling, with Mode change also Function is changed. For pAD11 to 16, the Mode setting has no effect and Mode is forced according to the Heat Pump Mode. Heat Pump has priority to pAD11 to 16.
Setpoint	6.0 to 32.0	°C	Requested Room Temperature set by user.
Temperature	-99.9 to 99.9	°C	Real Room Temperature
Rel. Humidity	0-100	%	Real Room Relative Humidity

Note: Terminal **pAD 01** – Main Room Terminal has absolute priority if it is installed.

Using PRG key enters detailed pAD setting menu.

3.2.4.1 pADxx Status

This mask is accessible pressing PRG key from the pADxx display.

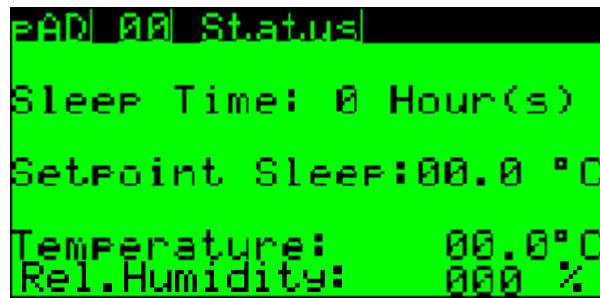

Parameter:	Range/F.:	Unit	Description
pAD	01, 11-16	-	pAD Identification Number. This Parameter is not adjustable. It is given by pAD Hardware Address. 01: Main Zone Room Terminal 11: Heating Circuit 1 Room Terminal 12: Heating Circuit 2 Room Terminal 13: Heating Circuit 3 Room Terminal 14: Heating Circuit 4 Room Terminal 15: Heating Circuit 5 Room Terminal 16: Heating Circuit 6 Room Terminal
Sleep Time	0-9	h	Remaining time of the pAD Sleep Function.
Setpoint Sleep	6.0 – 32.0	°C	Room Temperature Setpoint for pAD Sleep Function. Temporary Room Setpoint for the Sleep Time set. When Sleep Time elapses, Setpoint is returned to standart value set on the pAD.
Temperature	-99.9 to 99.9	°C	Real Room Temperature
Rel. Humidity	0-100	%	Real Room Relative Humidity

ESC key returns to pADxx Room Terminal display.

Using UP/DOWN keys lists in the pAD menu.

3.2.4.2 pADxx Scheduler

Scheduler setting consists of 2 displays.

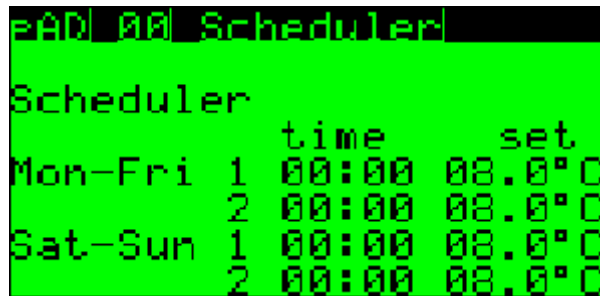
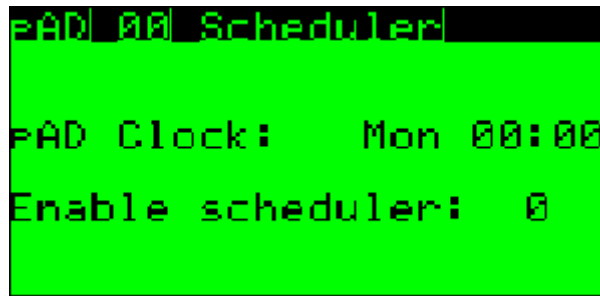

Parameter:	Range/F.:	Unit	Description
pAD	01, 11-16	-	pAD Identification Number. This Parameter is not adjustable. It is given by pAD Hardware Address. 01: Main Zone Room Terminal 11: Heating Circuit 1 Room Terminal 12: Heating Circuit 2 Room Terminal 13: Heating Circuit 3 Room Terminal 14: Heating Circuit 4 Room Terminal 15: Heating Circuit 5 Room Terminal 16: Heating Circuit 6 Room Terminal
pAD Clock	Mo-Su 00:00-23:59	d h:m	pAD actual time. Time is automatically synchronized with the main controller.
Enable Scheduler	0 1	-	0: Scheduler is not enabled. 1: Scheduler is enabled.
Mon-Fri time 1 2	00:00-23:59 00:00-23:59	h:m h:m	Start time of the first time zone for Monday to Friday. Start time of the second time zone for Mo to Fr.
Mon-Fri set 1 2	Off/6.0-32.0/On Off/6.0-32.0/On	°C/- °C/-	Room Setpoint, or simple On/Off request for TZ 1. Room Setpoint, or simple On/Off request for TZ 2.
Sat-Sun time 1 2	00:00-23:59 00:00-23:59	h:m h:m	Start time of the first time zone for Sat - Sun. Start time of the second time zone for Sat - Sun.
Sat-Sun set 1 2	Off/6.0-32.0/On Off/6.0-32.0/On	°C/- °C/-	Room Setpoint, or simple On/Off request for TZ 1. Room Setpoint, or simple On/Off request for TZ 2.

ESC key returns to pADxx Room Terminal display.
Using UP/DOWN keys lists in the pAD menu.

3.2.4.3 pADxx Alarms

If pAD is in Alarm Status it is possible to see it on this display.

```

pAD 00 Alarms
Temperature Probe: No
Humidity Probe:    No
Unit Offline:      No
pAD Active:        No
  
```

Parameter:	Range/F.:	Unit	Description
pAD	01, 11-16	-	pAD Identification Number. This Parameter is not adjustable. It is given by pAD Hardware Address. 01: Main Zone Room Terminal 11: Heating Circuit 1 Room Terminal 12: Heating Circuit 2 Room Terminal 13: Heating Circuit 3 Room Terminal 14: Heating Circuit 4 Room Terminal 15: Heating Circuit 5 Room Terminal 16: Heating Circuit 6 Room Terminal
Temperature Probe	No Yes	-	No: Temperature probe is not in alarm. Yes: Temperature probe has active alarm. Contact Your installation company, pAD must be replaced.
Humidity Probe	No Yes	-	No: Humidity probe is not in alarm. Yes: Humidity probe has active alarm. Contact Your installation company, pAD must be replaced.
Unit Offline	No Yes	-	No: Unit is Online, no alarm. Yes: Unit is Offline = alarm Please check proper pAD location in the plastic frame on the wall. If the position is correct, please contact installation company.

ESC key returns to pADxx Room Terminal display.

Using UP/DOWN keys lists in the pAD menu.

3.2.5 Heating Circuits

When additional Heating/Cooling Circuit or more Heating/Cooling Circuits are enabled during commissioning, following display(s) appears in the menu.

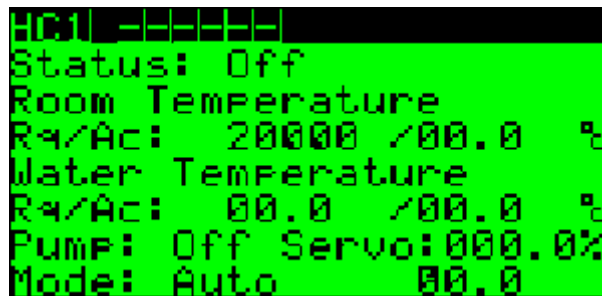

This display informs about the additional heating/cooling circuit status and enables the Automatic or Manual circuit operation.

Parameter:	Range/F.:	Unit	Description
HCx	1-6	-	Heating Circuit (HC) Identification
-----	alphanumeric	-	Up to 6 characters for customized HC name
Room Temperature Rq	6.0 32.0 F: 20.0	°C	Requested Room temperature set by user. When Room probe is not used, this value is considered to adjust the water temperature. When pAD room terminal is used, entered value is automatically transferred to the pAD and vice versa.
Room Temperature Ac	-99.9 99.9	°C	If room temperature probe is used or pAD room terminal is used, this value is showing the actual room temperature of the HCx Zone
Water Temperature Rq	-99.9 99.9	°C	xx.x: The first value is the requested temperature according to the weather compensation setting of the main heating/cooling circuit. /xx.x: The second value is the result of all requests from the other heating/cooling circuits and exactly the real requested setpoint for Heat Pump.
Water Temperature Ac	-99.9 99.9	°C	Actual HCx heating/cooling water temperature.
Pump	Off On	-	Off: HCx relay (pump) is not running. On: HCx relay (pump) is running.
Servo	0-100.0	%	Mixing valve position.
Mode	Auto Manual F: Auto	-	Auto: Automatic operation according to the setting of the main weather compensation curve. Manual: Manual operation according to entered value.
Manual Requested Temperature	*-99.9 99.9	°C	Requested heating/cooling water temperature set by user.

* The real temperature range is limited according to the setting during commissioning.

Key PRG opens Weather Compensation Curve setting for HCx.

3.2.5.1 HCx Heating Curve Setting

Pressing PRG from previous screen will show Main Heating Weather Compensation Setting display for Heating Circuit (HCx).

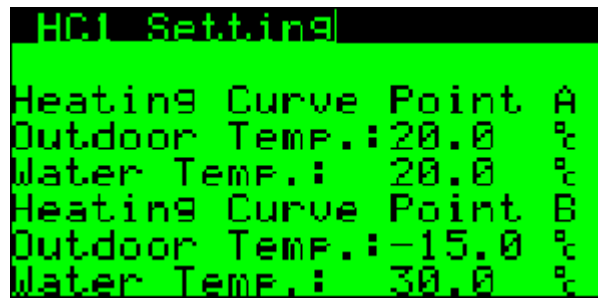

Weather compensation parameters could be shown on following picture:

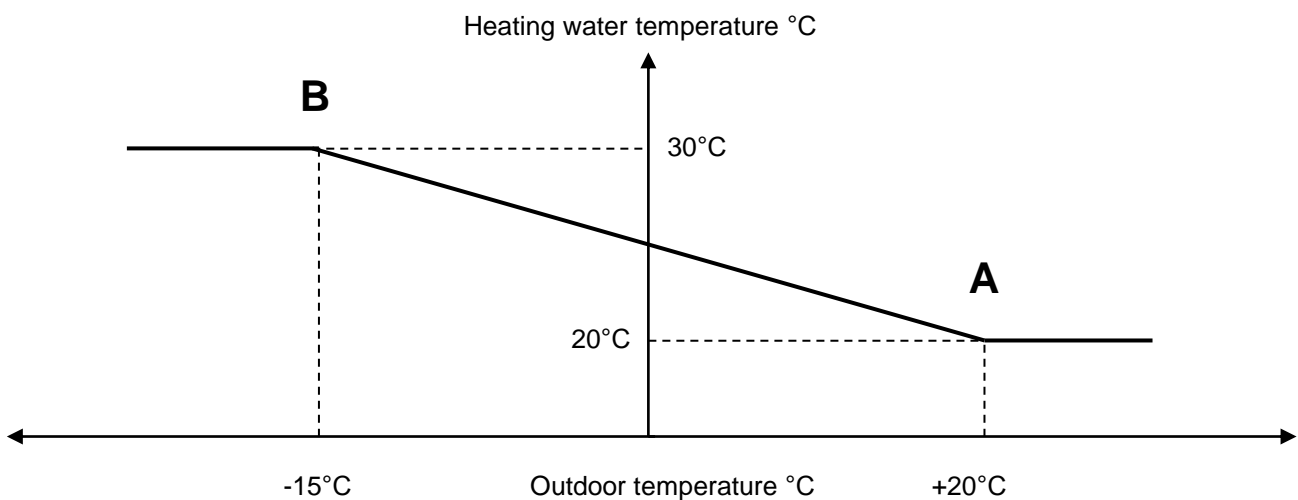

Parameter:	Range/F.:	Unit	Description
Point A Outdoor Temperature	-20.0 30.0 F: 20.0	°C	Point A, outdoor temperature definition.
Point A Water Temperature	*20.0 47.5 F: 20.0	°C	Point A, water temperature definition. Requested heating water temperature for defined Point A outdoor temperature. 20.0°C is typical setting for Under Floor Heating (UFH) and Radiators.
Point B Outdoor Temperature	-20.0 30.0 F: -15.0	°C	Point B, outdoor temperature definition.
Point B Water Temperature	*20.0 47.5 F: 30.0	°C	Point B, water temperature definition. Requested heating water temperature for defined Point B outdoor temperature. 30.0°C is typical setting for UFH. 40.0°C is typical setting for Radiators.

* The real temperature range is limited according to the setting during commissioning.

Use ESC key for return to previous display, HCx.

Use UP or DOWN key to reach the "HC1 Cooling Curve Setting", for units with Cooling, or Passive Cooling only.

3.2.5.2 HCx Cooling Curve Setting

This display is available only for units with Cooling, or Passive Cooling (Optional Equipment). Display enables setting of the HCx Cooling Weather Compensation.

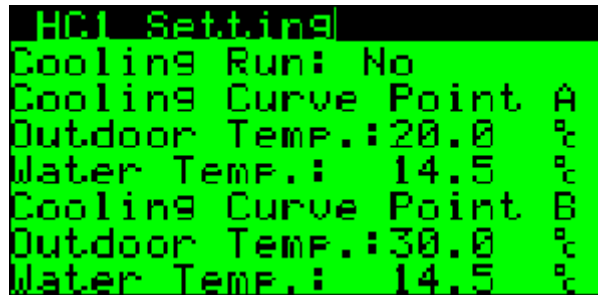

Weather compensation parameters could be shown on following picture:

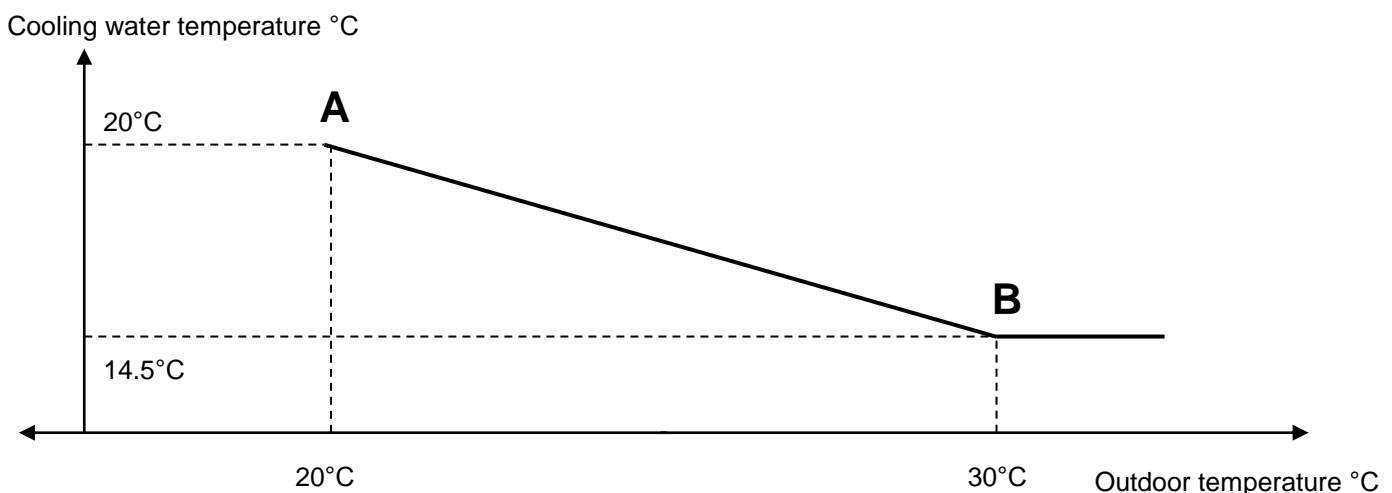

Parameter:	Range/F.:	Unit	Description
Cooling Run:	No Yes	-	No: HCx is not operating in Cooling Function. Yes: HCx is operating in Cooling Function
Point A Outdoor Temperature	10.0 40.0 F: 20.0	°C	Point A, outdoor temperature definition.
Point A Water Temperature	*14.5 30.0 F: 14.5	°C	Point A, water temperature definition. Requested cooling water temperature for defined Point A outdoor temperature. 20.0°C is typical setting for Under Floor Heating (UFH) and FanCoils.
Point B Outdoor Temperature	10.0 40.0 F: 30.0	°C	Point B, outdoor temperature definition.
Point B Water Temperature	*14.5 30.0 F: 14.5	°C	Point B, water temperature definition. Requested cooling water temperature for defined Point B outdoor temperature. 18.0°C is typical setting for UFH. 14.5°C is typical setting for FanCoils.

* The real temperature range is limited according to the setting during commissioning. Additional limitation is possible due to the Dew Point protection if it is activated.

Use ESC key for return to previous display, HCx.

3.2.5.3 HCx Custom Name

Following display enables setting of the Custom Name for Heating Circuit.



Each dash could be substituted by alphanumerical character.

Example: "1FLOOR"

This HCx "Name" appears on the main HCx mask.

3.2.5.4 Heating/Cooling Circuits (HCx) General Principle

- It is possible to enable up to 6 heating/cooling circuits
- As the heating/cooling circuits are configured during commissioning, requested setpoints with corresponding offsets are automatically transferred to the Main Heating/Cooling Circuit (Heat Pump)
- Heat Pump is always supplying highest temperature requested in the Heating Function and the lowest temperature requested in the Cooling Function, up to it's absolute limits.
- Each circuit could be equipped with pAD Room Terminal, which enables Scheduler and automatic water temperature adjusting to reach requested Room (Zone) temperature.

3.2.6 Solar

When Solar Thermal control is enabled, following display appears in the menu.

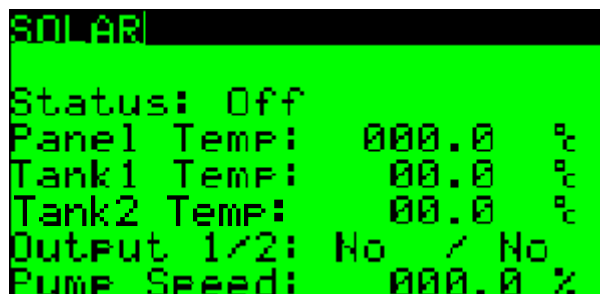

Parameter:	Range/F.:	Unit	Description
Status	Off On	-	Off: Control is disabled by the user. On: Control is enabled by the user.
Panel Temperature	-50.0 150.0	°C	Real Solar Panel temperature
Tank 1 Temperature	-50.0 99.9	°C	Real Storage Tank water temperature charged by Solar Thermal system.
Tank 2 Temperature	-50.0 99.9	°C	Real Storage Tank no.2, or additional demand side water temperature charged by Solar Thermal system. This value is shown only, when Storage Tank no.2 or additional demand side is configured (an example Swimming Pool)
Output 1/2	No, Yes	-	Relay Output no.1, or 2 status. No=Off, Yes=On
Pump Speed	0-100.0	%	Pump Speed, when Pump with variable speed is used.

3.2.7 Swimming Pool

When Swimming Pool control is enabled, following screen appears in the menu.

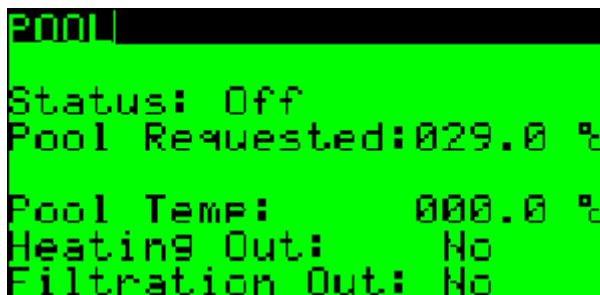

Parameter:	Range/F.:	Unit	Description
Status	Off On	-	Off: Control is disabled by the user. On: Control is enabled by the user.
Pool Requested Temperature	0.0 99.9	°C	Requested Swimming Pool water temperature set by user.
Pool Temperature	-50.0 99.9	°C	Real Swimming Pool water temperature.
Heating Out	No Yes	-	Yes: Swimming Pool heating is in operation
Filtration Out	No Yes	-	Yes: Filtration Pump in operation.

Press PRG for additional Swimming Pool setting.

3.2.7.1 Pool Filtration Timer Setting

This display enables swimming pool filtration configuration.

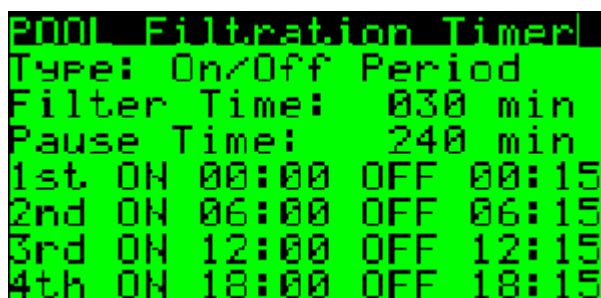

Parameter:	Range/F.:	Unit	Description
Type	On/Off Period Scheduler	-	On/Off Period: Filtration pump is activated according to the Filter/Pause Time principle. Scheduler: Filtration pumps is activated according to the Scheduler.
Filter Time	0 999	min	Filtration pump run period.
Pause Time	0 999	min	Filtration pump stop period.
1 st , 2 nd , 3 rd , 4 th ON/OFF	00:00 23:59	h:m	1st, 2nd, 3rd and 4th On/Off time scheduler definition.

Key ESC returns to the POOL mask.

3.2.8 Service Info

This is information display with refrigerant circuit operating parameters.

```

Service Info
StSht./DSht:08.0 /00.5
PV:0000      Power:005%
LP/HP:00.0  /00.0  bar
ET/CT:00.0  / 00.0  °C
S/DGT:00.0  /000.0  °C
S/Dht:00.0  /000.0  °C
Mode: DSht   Auto
    
```

Parameter:	Range/F.:	Unit	Description
StSht	-99.9 99.9	°C	Suction Superheat Setpoint.
StDSht	-99.9 99.9	°C	Discharge Superheat Setpoint.
PV	0 9999	-	Electronic Expansion Valve Position.
Power	0 100	%	Electronic Expansion Valve capacity request.
LP/HP	-1.0 45.0	bar	Actual Compressor Suction / Discharge Pressure.
ET/CT	-50.0 99.9	°C	Actual Evaporating/Condensing Temperature.
S/DGT	-50.0 150.0	°C	Actual Suction / Discharge Gas Temperature.
S/Dht	-50.0 99.9	°C	Actual Suction / Discharge Superheat.
Mode	SSht DSht	°C	Actual Control type. SSht: Suction Superheat Control DSht: Discharge Superheat Control

3.2.8.1 Defrost Info (Air/Water units only)

Pressing PRG key on previous screen opens Defrost Info mask.

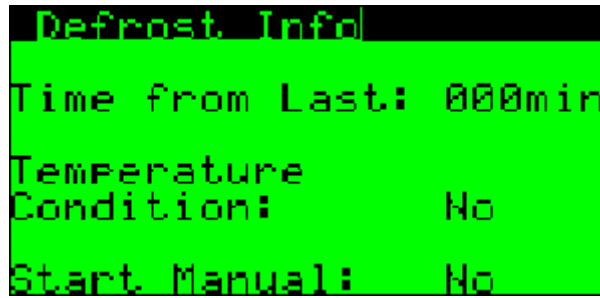

Parameter:	Range/F.:	Unit	Description
Time from Last Cycle	000 200	Min	Shows time from last defrost cycle. When period is longer than 200 minutes, the value is not increasing.
Temperature Condition	No Yes	-	Informs, if temperature condition starting the defrost cycle is met.
Start Manual	No Yes	-	When Temperature Condition is met, it is possible to manually activate the defrost cycle and bypass the minimum time between 2 defrost cycles, usually set to 45 minutes.

3.2.9 Clock

Clock screen is the Last screen of the Auxiliary Menu.

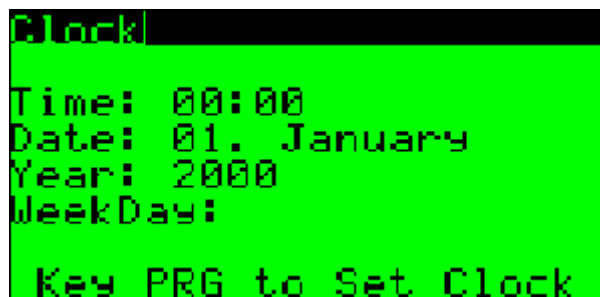

Parameter:	Range/F.:	Unit	Description
Time	00:00 23:59	h:m	Shows actual hours and minutes of the day.
Date	01. January 31. December	-	Day of the month and month.
Year	2000 2099	-	Shows actual year.
WeekDay	Monday Sunday	-	Shows day of the week.

Press PRG to set the Clock.

3.2.9.1 Setting the Clock

This display appears after pressing PRG key on previous screen.

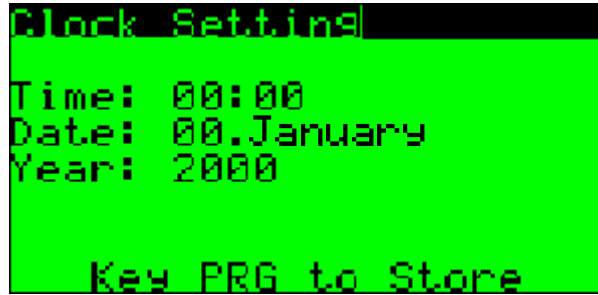

Parameter:	Range/F.:	Unit	Description
Time	00:00 23:59	h:m	Setting of the new time.
Date	01. January 31. December	-	Setting of the new day and month.
Year	2000 2099	-	Setting of the new year.

Important: After setting the new values press **PRG** key to **STORE** them, otherwise the new setting is lost.

Note: New clock setting is automatically distributed into pAD terminals.

3.2.9.2 Setting the Daylight Saving Time

This mask enables setting the automatic Daylight Saving Time (DST) changeover. Mask could be reached using UP/DOWN keys from previous screen.

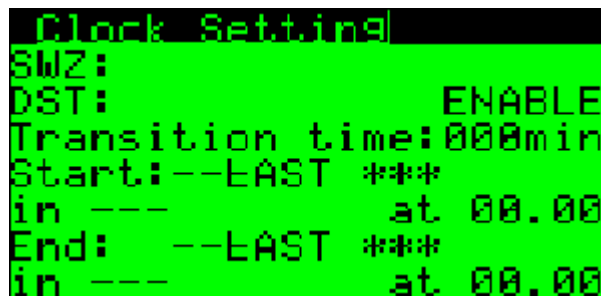

Parameter:	Range/F.:	Unit	Description
DST	Enable Disable	-	Enables or Disables automatic DST changeover.
Transition time	0 999	min	Time for changeover, when unit was not powered.
Start	First Second Third Forth Last Mon-Sun	-	Day of the Month to start the DST
At	00:00 23:59	h:m	Time to start DST

Parameter:	Range/F.:	Unit	Description
End	First Second Third Forth Last Mon-Sun	-	Day of the Month to stop DST
At	00:00 23:59	h:m	Time to stop DST

4 Alarms

Alarms may occur while the unit is in operation. The control is drawn up in such a manner that the operation can be restarted automatically. If a problem is more serious, it is necessary to reset the unit manually.

If an alarm state occurred during the operation of the unit, the backlighting of ALR key flashes on and off. If the backlighting of the key is lit steadily, the unit has been blocked and it is necessary to reset it manually.

By pressing ALARM button, the screen with active alarms, or last active alarm will be displayed.

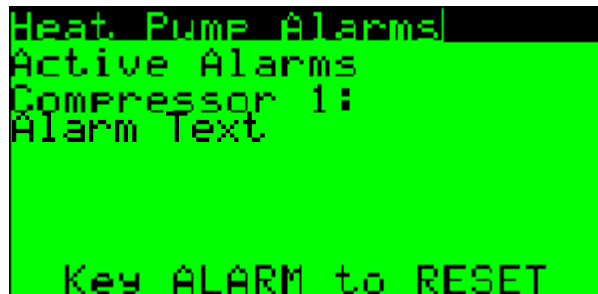

If the unit is equipped with 2 compressors, alarms are showing separately for each compressor.

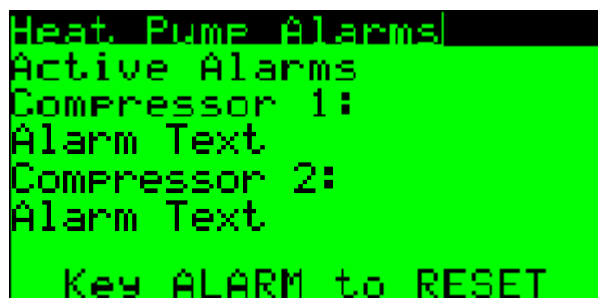

4.1 Types of alarm

Displayed Alarm Text	Alarm Code	Alarm description	Reset
Low Pressure	AL01	compressor low suction pressure	aut.<3/hrs
High Pressure PT	AL02	compressor high discharge pressure from pressure transducer	aut.<3/hrs
High Discharge Temp.	AL03	high compressor discharge gas temperature	aut.<3/hrs
High Condensing Temp.	AL04	too high refrigerant condensing temperature	aut.<3/hrs
Low Evaporating Temp.	AL05	too low evaporating temperature	aut.<3/hrs
Antifreeze	AL06	low water temperature with risk of freezing	aut.<3/hrs
Fan Thermal	AL07	fan overheating, or circuit breaker activation brine pump overheating or circuit breaker activation	aut.<3/hrs
Compressor Thermal	AL08	compressor overheating, or circuit breaker activation	aut.<3/hrs
Flow	AL09	inufficient or no flow of water thru heat pump	aut.<3/hrs
Probes	AL10	one of the important temperature sensor malfunction	automatic
High Pressure Switch	AL11	compressor high discharge pressure from pressure high pressure switch	aut.<3/hrs
Low Pressure HP side	AL12	too low pressure on high pressure side of the refrigerant circuit	aut.<3/hrs
DC Drive Alarm	AL13	alarm of the compressor drive for inverter units	automatic
EVD Evo	AL14	alarm of the Electronic Expansion Valve driver	aut.<3/hrs

4.2 General Alarm Explanation

Heat Pump is complex device consisting of sensitive components. Therefore control system switches the operation off in case the operating conditions are not suitable for unit safe and long durability operation. Operating conditions are given externally, by the actual status of power supply, actual load and operating mode request. Alarms could occur during unit standard unit operation. Until unit is not in permanent alarm, or it does not require manual reset, there is no reason to concern.

4.3 Detailed Alarm Displays

Using UP/DOWN keys lists in the alarm menu. Detailed display is available for each alarm. It shows active or inactive alarm and total alarm counter.

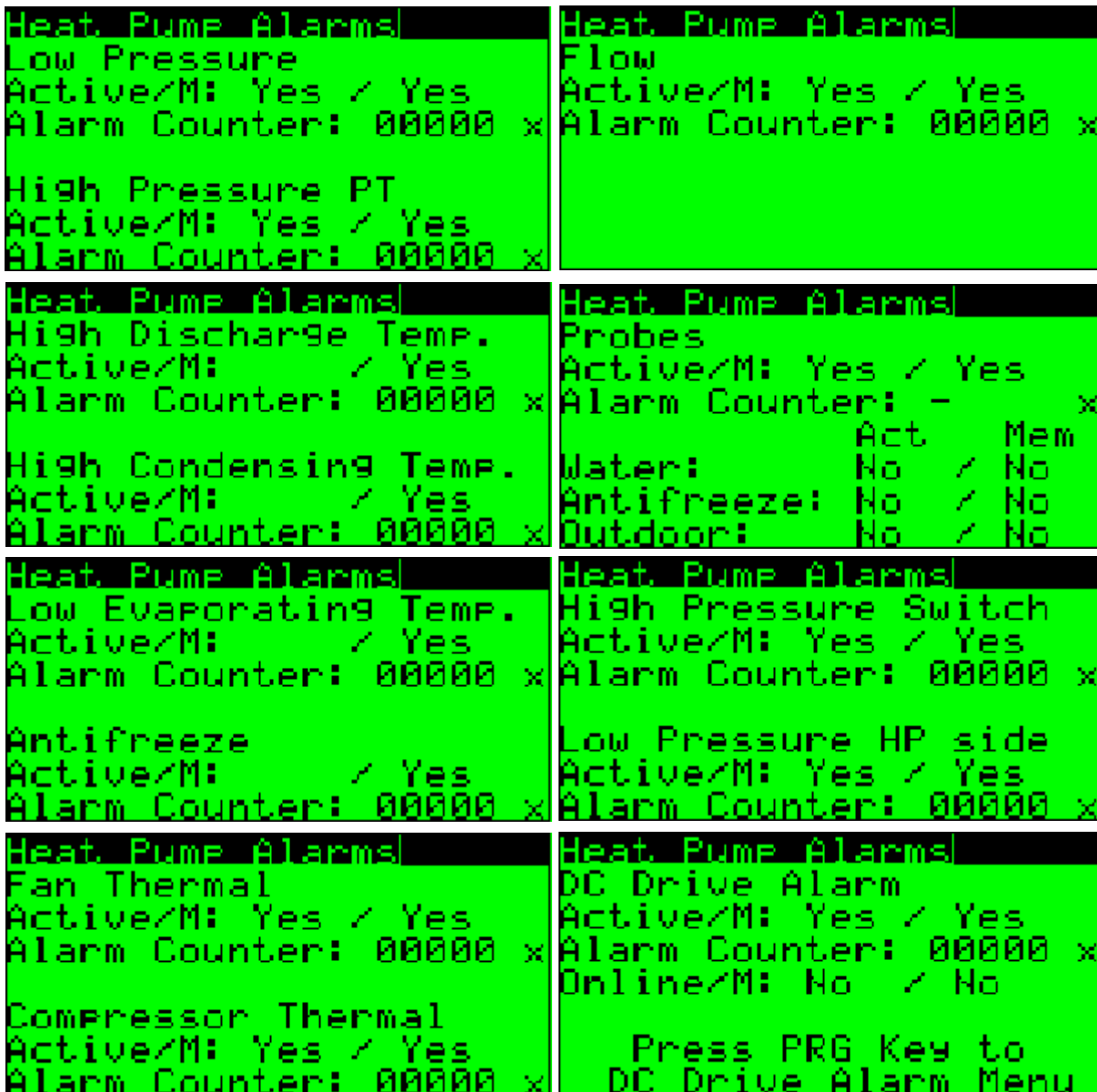

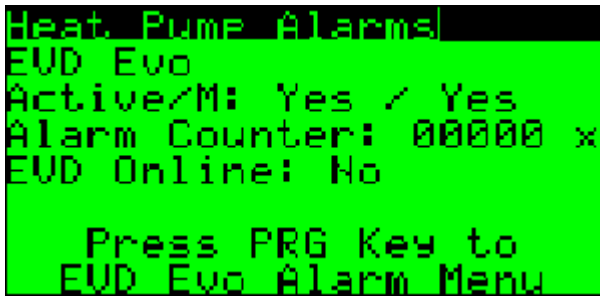

Parameter:	Range/F.:	Unit	Description
Active	No Yes	-	No: Alarm is not active. Yes: Alarm is actually active.
/M (Memory)	No Yes	-	No: Alarm is not active in memory Yes: Alarm is active in memory, control system is waiting minimum compressor Off time for recovery.
Alarm Counter	0 32000	-	Shows how many alarms of this type happened during unit operation from last counter reset.

Note: For DC Drive and EVD Evo alarms it is possible to enter detailed alarm menu pressing PRG key. You can be asked to enter detailed alarm menu to assist with problem recognition before visit of the service dealer.

4.4 Warnings

Following alarms are not causing unit to stop, but some unit functions could be limited.

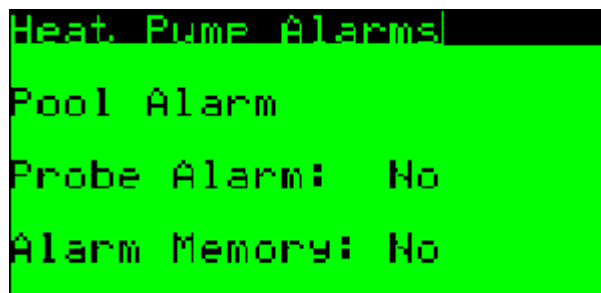
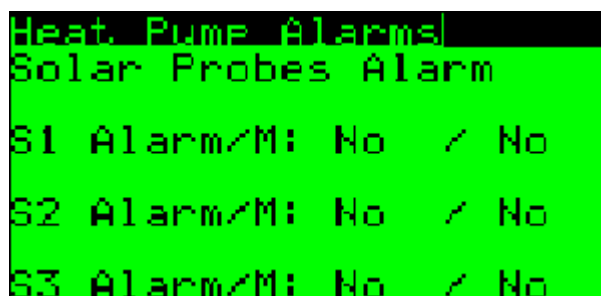
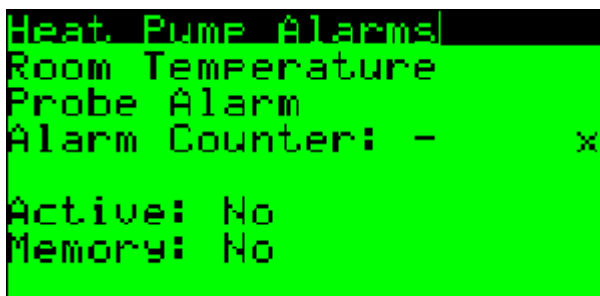
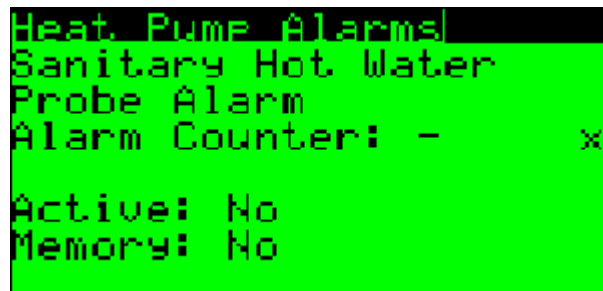
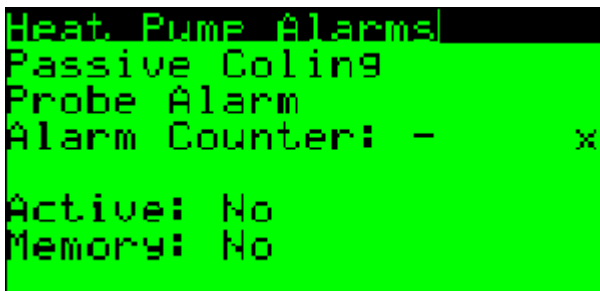

4.5 To reset alarms

All alarms are reset automatically if the count of one type does not reach 3 in 1 operating hour of the compressor.

4.6 Manual reset

The manual reset is carried out by entering the alarm menu after pressing the ALARM key. Additional pressing of the ALARM key on any alarm display performs Manual Reset

5 What to do if....

5.1 After power is on, the backlighting of the ALR key flashes

It is a normal operating state. The operation of the heat pump is restored after 6 minutes, unless any of the alarms is really active. During this period, all alarms on the alarm screen are displayed as active.

5.2 The main screen with icons shows the symbol flashing

It informs that the regular maintenance period for the unit has elapsed. This situation is NOT ALARM and unit continues in normal operation. After typical compressor time in operation, it is recommended refrigerant circuit service inspection. Typical time is 3000 operating hours, therefore we recommend service inspection in 6 months from service icon appearing.

5.3 The symbol is lit

It indicates the high electric power tariff or remote Off.

5.4 The backlighting of the ALARM key flashes

It informs about an active alarm. Press this key shortly to display the type of the alarm. If the key keeps flashing, automatic reset will be performed and the unit will be put into operation in 6 minutes.

5.5 The ALARM key is lit steadily

The operation of the unit has been blocked as the same active alarm has been detected 3x during 1 operating hour of the compressor.

Press the ALARM key to display the type of the alarm. Refer to the table „What to do in the case of difficulties“ as it must be a more serious failure.

Reset the unit manually according to Chapter 4.6.

5.6 Active icon

The outdoor temperature has dropped below the application limit of the compressor. The compressor is turned off and the heating function is taken over by both of the heating elements. When the outdoor temperature rises above the limit, the compressor will be restarted automatically.

5.7 Defrosting icon flashes

It informs that the temperature conditions to activate defrosting have been met, however, the necessary time between the defrosting cycles has not elapsed yet. It is a normal operating state.

5.8 Defrosting icon is steadily lit

It informs that the defrosting cycle is in progress. At first the compressor and fan are stopped, next the reverse valve is activated and then the compressor is restarted. The defrosting cycle is completed by starting the fan and switching the reversing valve into the heating mode. During this mode the steam/fog could appears in the area of the outdoor unit.

5.9 E! appears on the Main Screen

Safety thermostat of the electric heater was activated and heater could not be switched on. It is necessary to open the front cover and manually reset this device. Before resetting, please check water inlet filter strainer, sufficient heating water filling and pressure.

5.10 Pump symbol is flashing on the Main Screen



When icon is flashing more than 10s after the circulating pump start, the flow did not start and pump was switched off to protect it from damaging. This situation is called “Pump Alarm”. System tries to restart the pump each compressor off time. This situation is usually connected to “Flow Alarm”. Please check water inlet filter strainer, sufficient heating water filling and pressure.

6 Switchboard

The switchboard is accessible after the main switch is off and the front door of the heat pump is opened. The switchboard comprises all power cut-out devices and electronics. The layout is presented in the following figure:

6.1 AirMaster, EasyMaster, AquaMaster

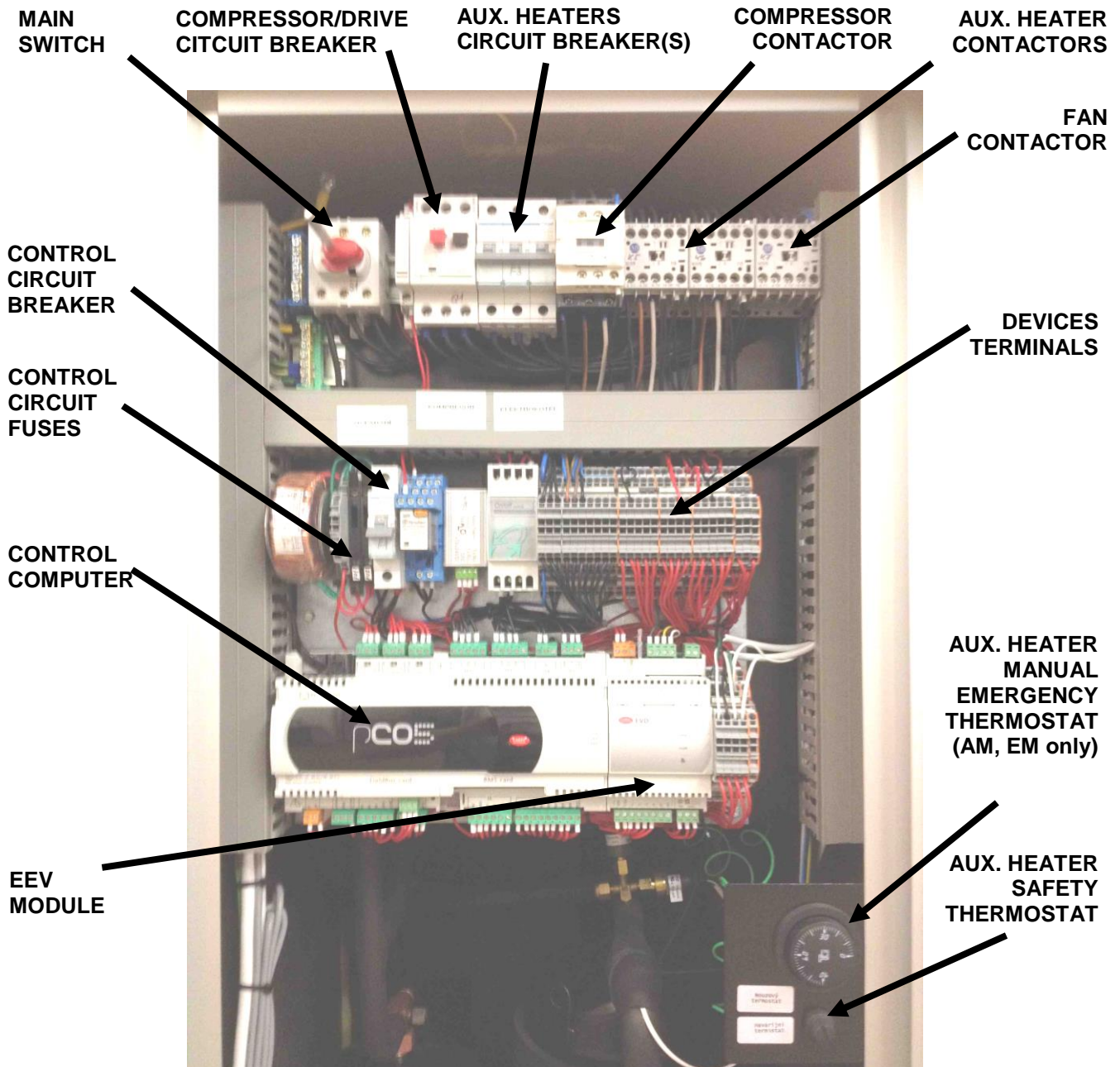

WARNING:
BEFORE OPENING THE FRONT COVER, DISCONNECT THE POWER SUPPLY TO THE UNIT IN THE HOUSE MAIN ELECTRIC DISTRIBUTOR !

6.2 BoxAir

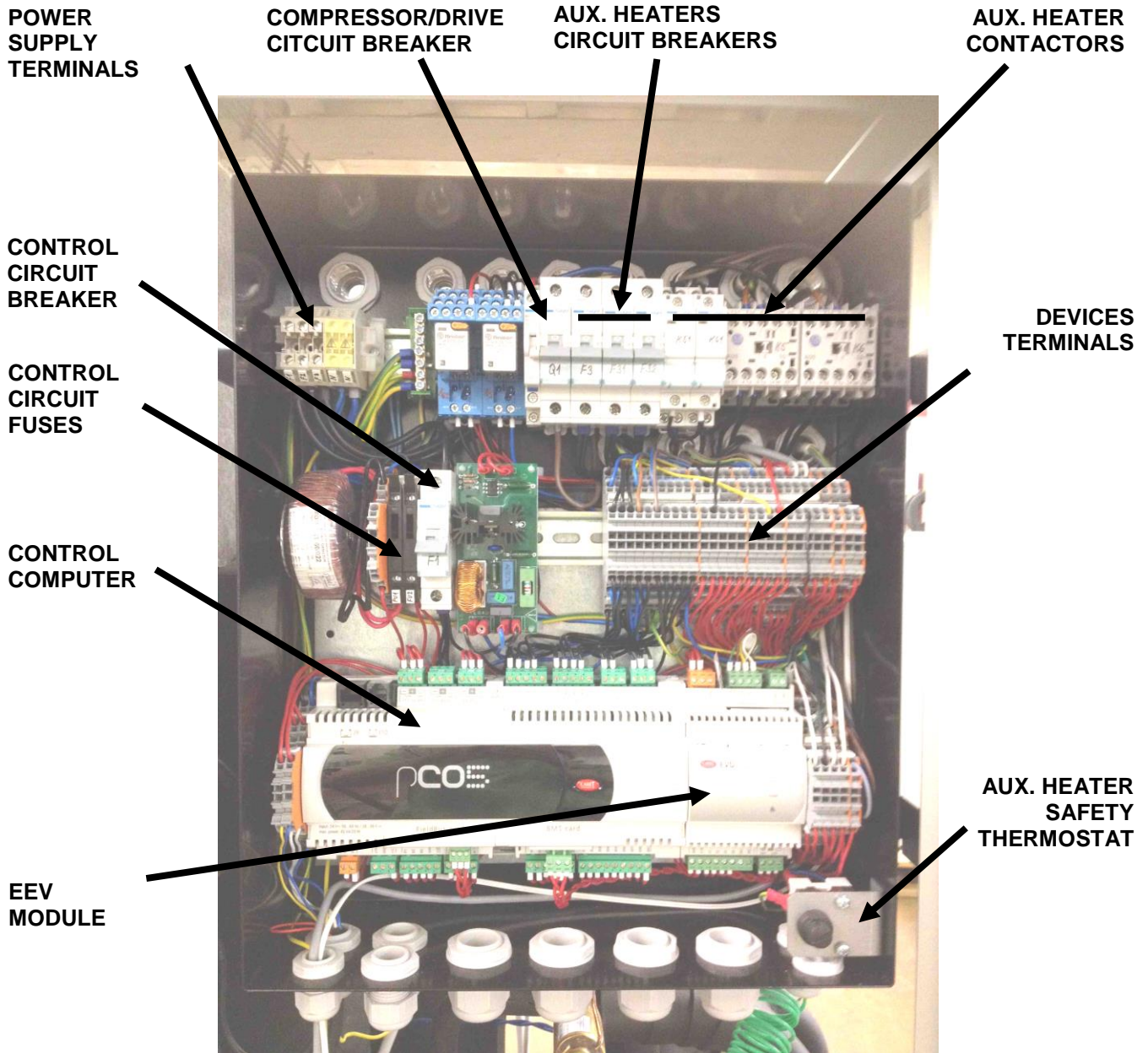

WARNING:
BEFORE OPENING THE FRONT COVER, DISCONNECT THE POWER SUPPLY TO THE UNIT IN THE HOUSE MAIN ELECTRIC DISTRIBUTOR !

6.3 Main switch

It is used to turn off the power supply leading to the heat pump switchboard.

6.4 Control circuit breaker

It protects the control devices, circulating pumps, etc.

6.5 Control Circuit Fuses

There are 2 fuses for protecting the transformer. The first is on high voltage side and the second is on the low voltage side. Please check supplied wiring diagram for correct fuse sizing. From production there is always 1 spare fuse on both sides inside the fuse box.

6.6 Auxiliary Heater Safety Thermostat

It is used to block the heaters in the case of its overheating (more than 70°C). For units with integrated storage tank also auxiliary heater circuit breaker is tripped. If this protection is activated, it is necessary to unscrew the thermoregulator plastic cover (anti-clockwise) and press the button located under the cover. If this activation occurred, inform please the installation company about this event.

6.7 Emergency Auxiliary Heater Manual Thermostat

The purpose of the emergency thermoregulator is to ensure emergency operation in the case of compressor outage. The reset is done by turning the thermoregulator to the desired temperature of heating water. By default, the maximum temperature of the thermoregulator has been inhibited to 50°C.

6.8 Auxiliary Heater Circuit Breaker

It is the electric protection element for electric heating rods. The failure may happen for two reasons. Either it is due to excessively heated integrated storage vessel, refer to Chapter 6.6, or there is a short circuit in the electric circuit of the rods. In either case, contact the installation company should a failure like this occurs.

6.9 Compressor circuit breaker

It is a starting circuit breaker for the compressor motor with integrated thermal protection for winding. The manufacturer of the heat pump has adjusted the maximum service current for the compressor on the circuit breaker. It is not allowed to modify this setting. If the service current is adjusted incorrectly, the compressor may get damaged.

7 Troubleshooting

7.1 Water/Water, Brine/Water Heat Pumps

The following chart lists alarms and activities of the operator to rectify the error state.

CODE	Meaning	Control action	Reason	Before you call service
AL01	Low pressure	Switches off compressor and brine circulator	Low closed loop temperature, evaporator freezing, brine circulator malfunction, full closed loop strainer	Switch off unit, clean closed loop strainer, check brine pressure of the closed loop, repeated problem - call service
AL02	High pressure PT	Switches off compressor and brine circulator	Too high water temperature, full water strainer, water circulator malfunction	Decrease requested water temperature, check deaerating and water filling, clean water strainer, repeated problem - call service
AL03	High Discharge Temperature	Switches off compressor and brine circulator	Too high water temperature, full water strainer, water circulator malfunction. Could be caused also from slight refrigerant leaking, or temperature probe problem (AL10)	Decrease requested water temperature, check deaerating and water filling, clean water strainer, repeated problem - call service
AL04	High Condensing Temperature in heating/cooling mode	Switches off compressor and brine circulator	Too high water/brine temperature, full water/brine strainer, water/brine circulator malfunction	Decrease requested water temperature, check deaerating and water/brine filling, clean water/brine strainer, repeated problem - call service
AL05	Low Evaporating Temperature heating/cooling mode	Switches off compressor and brine circulator	Low closed loop/cooling water temperature, evaporator freezing, brine/water circulator malfunction, full closed loop/water strainer	Switch off unit, clean closed loop/water strainer, check brine/water pressure, repeated problem - call service
AL06	Antifreeze water protection	Switches off compressor and brine circulator	Low heating/cooling water temperature	Could be caused during long electricity supply problem, or by low water temperature in cooling mode. Wait for heating of the water by auxiliary heater, increase requested water temperature if cooling mode.
AL07	Brine Pump Malfunction (AQ120.2, 150.2, 180.2 only)	Switches off compressor and brine circulator	Brine circulator motor overheating problem, or circuit breaker activation.	Call service

CODE	Meaning	Control action	Reason	Before you call service
AL08	Compressor Thermal Protection	Switches off compressor and brine circulator	Too high water temperature, power supply problem - missing phase, compressor motor malfunction	Switch on compressor circuit breaker, call service, if problem returns.
AL09	Low cooling/heating water flow	Switches off compressor and brine circulator	Circulator malfunction, full strainer cooling/heating water	Switch unit off, check water strainer. Repeated problem - call service
AL10	Temperature probe problem	Switches off compressor and brine circulator	Probe malfunction	Call service
AL11	High Pressure Switch	See AL01, AL02	See AL01, AL02	See AL01, AL02
AL12	Low Pressure HP Side	See AL01, AL02	See AL01, AL02	See AL01, AL02
AL13	DC Drive Alarm, Inverter units only	Switches off compressor and brine circulator	Compressor DC Drive Error	Restart unit power supply, if problem returns, please call service
AL14	EVD Evo Alarm	Switches off compressor and brine circulator	Malfunction of EVD Evo module	Restart unit power supply, if problem returns, please call service

7.2 Air/Water Heat Pumps

The following chart lists alarms and activities of the operator to rectify the error state.

CODE	Meaning	Control action	Reason	Before you call service
AL 01	Low pressure	Switches off the compressor and fan	Extremely low temperature of the outdoor air (below -20°C), freezing of the evaporator, operating failure of the fan	Wait for the error status to come to an end, in the case of the freezing of the evaporator, wait for the starting of the unit and perform a manual defrost; if the error occurs repeatedly, contact the installation company
AL 02	High pressure PT	Switches off the compressor and fan	Too high a temperature of the heating water	Reduce the required heating water temperature, check the bleeding and filling of the system, and check and clean the heating water filter; report the error to the installation company if it occurs repeatedly
AL 03	High Discharge Temperature	Switches off the compressor and fan	This error may be caused by insufficient coolant filling or its minor leaks; it may also be caused by a high temperature of the heating water or an extremely low outdoor air temperature. This error also occurs in the case of a sensor failure (AL 10)	Reduce the required heating water temperature, check the bleeding and filling of the system, and check and clean the heating water filter; report the error to the installation company if it occurs repeatedly
AL 04	High Condensing Temperature in heating/cooling mode	Switches off the compressor and fan	In the thawing mode, too high a temperature has been set for the end of thawing; in the cooling mode, a failure of the fan	Check the outdoor unit, and perform a manual reset; the installation company must be contacted
AL 05	Low Evaporating Temperature heating/cooling mode	Switches off the compressor and fan	Extremely low temperature of the outdoor air (below -20°C), freezing of the evaporator, operation failure of the fan	Wait for the error status to come to an end; in the case of the freezing of the evaporator, wait for the starting of the unit and perform a manual thawing; if the error occurs repeatedly, contact the installation company

CODE	Meaning	Control action	Reason	Before you call service
AL 06	Antifreeze water protection	Switches off the compressor and fan	Low temperature of the heating water	Check the circuit-breaker of the built-in electric boiler; check whether the cooling mode has not been activated by mistake
AL 07	Fan Thermal Protection	Switches off the compressor and fan	Fan overloading, faulty fan	Check the outdoor unit, and perform a manual reset; the installation company must be contacted
AL 08	Compressor Thermal Protection	Switches off the compressor	Too high a temperature of the heating water, incorrect setting of the heat protection of the compressor, faulty compressor	Reset the circuit-breaker of the compressor; contact the installation company
AL 09	Low cooling/heating water flow	Switches off the compressor and fan	Circulation pump error, clogged heating water filter	Check and clean the heating water filter. If the error occurs repeatedly, contact the installation company
AL 10	Temperature probe problem	Switches off the compressor and fan	Faulty sensor	Contact the installation company.
AL11	High Pressure Switch	See AL01, AL02	See AL01, AL02	See AL01, AL02, always call service
AL12	Low Pressure HP Side	See AL01, AL02	See AL01, AL02	See AL01, AL02, always call service
AL13	DC Drive Alarm, Inverter units only	Switches off compressor and fan	Pressure transducer malfunction	Call service
AL14	EVD Evo Alarm	Switches off compressor and fan	Malfunction of EVD400 module	Call service

7.3 Reseting Circuit Breakers

Please check the chapter “6 Switchboard” to find correct device and use device switch to reset it.

WARNING:

BEFORE OPENING THE FRONT COVER, DISCONNECT THE POWER SUPPLY TO THE UNIT IN THE HOUSE MAIN ELECTRIC DISTRIBUTOR !

7.4 Reseting the Auxiliary Heater Safety Thermostat

Activation of this safety device is signalized by appearing the “E!” symbol on the Main Screen. Please check the chapter “6 Switchboard” to find device location inside Your unit. If this protection is activated, it is necessary to unscrew the thermoregulator plastic cover (anti-clockwise) and press the button located under the cover. If this activation occurred, inform please the installation company about this event.

WARNING:

BEFORE OPENING THE FRONT COVER, DISCONNECT THE POWER SUPPLY TO THE UNIT IN THE HOUSE MAIN ELECTRIC DISTRIBUTOR !

7.5 Defrost Cycle (Air/Water only)

Due to the principle of operation of Air/Water Heat Pumps, there is air humidity condensation or ice creation on the outdoor unit heat exchanger. From this reason, control system is continuously checking unit efficiency and when snow/ice layer is too big, the defrost cycle is initiated. Firstly the compressor and fan are stopped, next the reverse valve is activated and then the compressor is restarted. The defrosting cycle is completed by starting the fan and switching the reversing valve into the heating mode. During this mode the steam/fog could appear in the area of the outdoor unit.

7.5.1 Activating of the Manual Defrost

Defrosting cycle is performed automatically by the control system. From reason of extreme weather conditions with combination of power supply malfunction, the standard automatic procedure might not be sufficient to fully remove the snow/ice from heat exchanger. From this reason it is possible to activate the defrost cycle manually from pDG display, pressing the UP and DOWN key simultaneously.

Manual defrost could be also activated from the “Defrost Info” mask, please see chapter 3.2.8.1. Reversible units could be also defrosted by setting the unit to the Cooling Function, please see chapter 3.2.1 “Setting Unit Operation”.

8 Declaration of Conformity



MasterTherm

Master Therm tepelná čerpadla s.r.o.
Václavské Náměstí 819/43, 110 00 Praha 1, Czech Republic

ID: 28892275



EC DECLARATION OF CONFORMITY

acc. to §22 act no. 22/1997 Sb. as ammended by the act no.71/2000 Sb

Product: Heat Pump air/water AirMaster, EasyMaster, BoxAir, BoxAir Inverter

Models: AM3015, AM3021, AM3030, AM3038, AM3045, AM3060.2, AM3076.2, AM3090.2
EM26, EM30, EM37, EM60, EM75
BA17, BA22, BA26, BA30, BA37, BA45, BA22I, BA26I, BA30I, BA37I, BA45I, BA60I

Manufacturer: Master Therm tepelná čerpadla s.r.o., Praha, Czech Republic

Product Description:

Appliance for energy trasfer from Renewable Energy Sources to Heating,
Cooling and Sanitary Hot Water.

Declares that the components of the above mentioned units are conforming to the following directives and standards:

NV č.163/2002 Sb.
NV č.117/2016 Sb.
ČSN EN 60335-2-40, ČSN EN 60335-1, ČSN ISO 11200
ČSN EN 378-1 to 4, ČSN EN 13136, ČSN EN 12263, ČSN EN12102
ČSN EN 60704-2-2, ČSN EN 14511-2, -3, -4, ČSN EN 16147
ČSN EN14825
ČSN EN 55011
ČSN EN 61000-3-2, ČSN EN 61000-3-12, ČSN EN 61000-3-3
(EU) No.811/2013, No.813/2013

Conformity: according to §7 art. 2 Czech Republic government directive No.163/2002 Sb.

No. of sheets: 1



Praha 1.10.2018

Ing. Karel Guzek
company executive



EC DECLARATION OF CONFORMITY

acc. to §22 act no. 22/1997 Sb. as ammended by the act no.71/2000 Sb

Product: Heat Pump water (brine) / water AquaMaster, AquaMaster Inverter

Models: AQ17Z, AQ22Z, AQ22I, AQ22IC, AQ26I, AQ26IC, AQ26Z
AQ30Z, AQ30I, AQ30IC, AQ37Z, AQ37I, AQ37IC, AQ45Z
AQ45I, AQ45IC, AQ50Z, AQ60Z, AQ60I, AQ75Z, AQ90Z, AQ90I
AQ17Z1, AQ22Z1, AQ26Z1, AQ30Z1, AQ37Z1, AQ50Z1, AQ60Z1
AQ120.2Z, AQ150.2Z, AQ180.2Z

Manufacturer: Master Therm tepelná čerpadla s.r.o., Praha, ČR

Product Description:

Appliance for energy trasfer from Renewable Energy Sources to Heating,
Cooling and Sanitary Hot Water.

Declares that the components of the above mentioned units are conform to the following directives and standards:

NV č.163/2002 Sb.
NV č.117/2016 Sb.
ČSN EN 60335-2-40, ČSN EN 60335-1, ČSN ISO 11200
ČSN EN 378-1 to 4, ČSN EN 13136, ČSN EN 12263, ČSN EN12102
ČSN EN 60704-2-2, ČSN EN 14511-2, -3, -4, ČSN EN 16147
ČSN EN14825
ČSN EN 55011
ČSN EN 61000-3-2, ČSN EN 61000-3-12, ČSN EN 61000-3-3
(EU) No.811/2013, No.813/2013

Conformity: according to §7 art. 2 Czech Republic government directive No.163/2002 Sb.

No. of sheets: 1

Praha

2.1.2018

Ing. Karel Guzek
company executive

9 Safety and Environment Protection

9.1 Greenhouse Gas

Heat Pumps contains greenhouse gas – refrigerant charge listed in Kjoto Protocol. Venting refrigerant into atmosphere is not allowed.

9.2 Hermetical Sealing

All units are hermetically sealed system after installation.

10 Energy Labeling

For Energy Labeling informations according to directives (EU) No.811/2013 and No.813/2013, please see document “Technical Parameters according to Regulation (EU) No.811/2013 and No.813/2013” for specific Heat Pump model.

11 Dismantling & Disposal

Heat Pumps must be removed from the system by qualified personel with necessary approval only.

Do not dispose used and dismantled device or device parts to the municipal waste, but to the special Large Home Appliance waste center or to local supplier.

Warning:

**Heat Pumps contains greenhouse gas – refrigerant, listed in Kjoto Protocol.
Venting refrigerant into atmosphere is not allowed.**

