



Internet module

ecoNET300

REMOTE CONTROL OF ecoMAX REGULATORS



www.econet24.com



OPERATION AND INSTALLATION MANUAL

ISSUE: 1.0

CAN BE APPLIED TO:

OPERATIONAL
SYSTEM:

WINDOWS XP,7,8,
Android, Linux

REGULATOR NAME:

ecoMAX 800 series
(excluding ecoMAX800R1, T1), 850, 860



SAFETY



CONNECTION



SETTINGS



SERVICE



This sign indicates relation to safety issues.



This sign indicates relations to module functional features.



Always turn boiler off before connecting the device.



Do not use the device for other than intended use .



Verify if boiler controller software is adapted to cooperate with ecoNET300 internet module.



Connecting the module not in accordance with the manual or improperly can result in inappropriate operation of the controller or interruption of its operation.



Device can be started and connected only by a person who read this manual.



In any circumstances do not modify construction of the device.



CONTENTS

INFORMATION..... 6

COOPERATION OF ecoNET300 with ecoMAX CONTROLLERS 7

THE ecoMAX CONTROLLER WITH MODULES..... 7

CONNECTING WITH ecoMAX800 CONTROLLERS 8

CONNECTION WITH ecoMAX850 SERIES CONTROLLERS 9

CONNECTION WITH ecoMAX860 CONTROLLER..... 10

CONNECTION WITH INTERNET NETWORK 11

LOGGING TO THE MODULE FROM A LEVEL OF LOCAL LAN NETWORK 16

LOGGING INTO ecoNET ACCOUNT..... 17

A WEBSITE FOR MANAGING OPERATION OF THE BOILER CONTROLLER 20



INFORMATION

ecoNET300 enables boiler operation remote control via Internet or a local network. User can remotely monitor operation of the boiler and modify operation parameters of the boiler controller with the use of a tablet or mobile phone.

www.econet24.com



Essential features of the module:

- ✓ ecoNET300 integrated WWW server enabling remote control of operation of the boiler within a local network without Internet access,
- ✓ cooperation with www.econet24.com external server provides access to boiler controller via Internet,
- ✓ supports Wi-Fi wireless networks,
- ✓ preview of current operation parameters of the boiler in readable and clear "tiles",
- ✓ visualization via readable hydraulic diagram indicating current operation of the hydraulic system,
- ✓ preview and edition options of most (user and service) parameters of the controller,
- ✓ registration of operation parameters and alarm conditions of the controller,
- ✓ possibility of e-mail notifications concerning alarm conditions of the controller.



COOPERATION OF ecoNET300 with ECOMAX CONTROLLERS



ecoNET300 internet module will cooperate only with boiler controllers with installed software supporting ecoNET300.

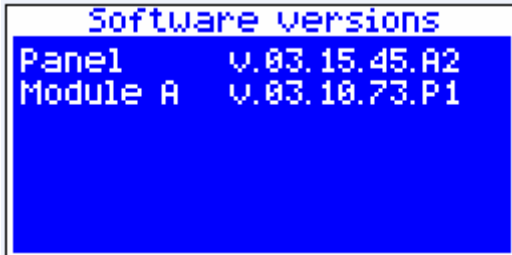

Check regulator software version before connecting a module with the controller.

In the controller menu select tab:

MENU → **Information** → **Software versions**

User can contact with the boiler or controller manufacture in order to verify whether a particular type of boiler controller will be cooperating with ecoNET300 according to data concerning controller software versions.

THE ecoMAX CONTROLLER WITH MODULES



In order to connect the ecoNET300 module with the controller, **ecoLINK2** interface is required which is a part of the set.

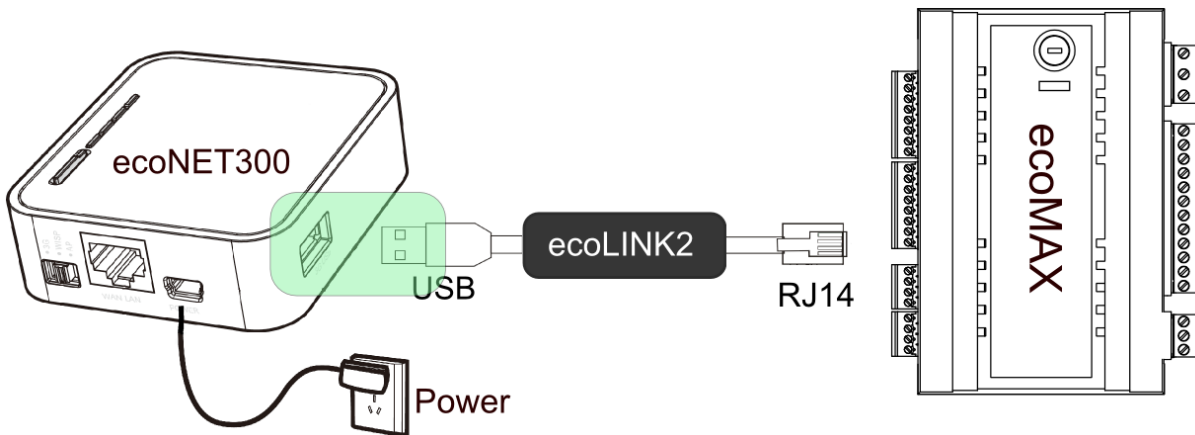

The ecoNET300 internet module has to be connected with ecoMAX boiler controller with the use of ecoLINK2 interface. In case of some types of controllers it is necessary to use an appropriate adapter. ecoLINK2 interface and adapter are a part of the ecoNET300 set.

Further parts of the manual contain methods of connecting a module with particular types of controllers.



CONNECTING WITH ecoMAX800 CONTROLLERS

This chapter applies to **ecoMAX800 P1, P2, R2, T2, D1, D2** controllers. It is not applicable to **ecoMAX800R1** and **ecoMAX800T1**. In case of ecoMAX800 series, a **EL2adapter** must be used in order to connect ecoLINK2.

The following diagram shows a connection method.

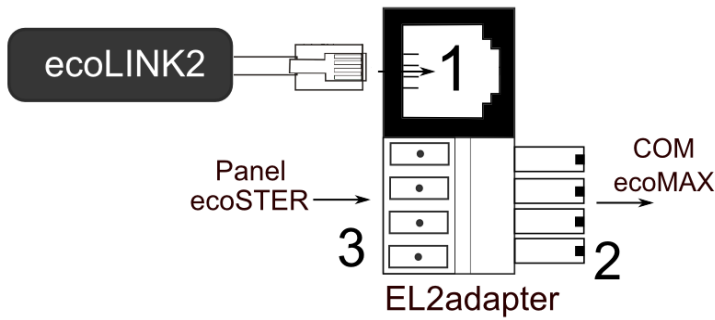

EL2adapter, where
 1- Socket for RJ14 ecoLINK2 interface,
 2- A plug for controller module COM transmission socket,
 3- Socket for a control panel plug (together with ecoSTER room panel).

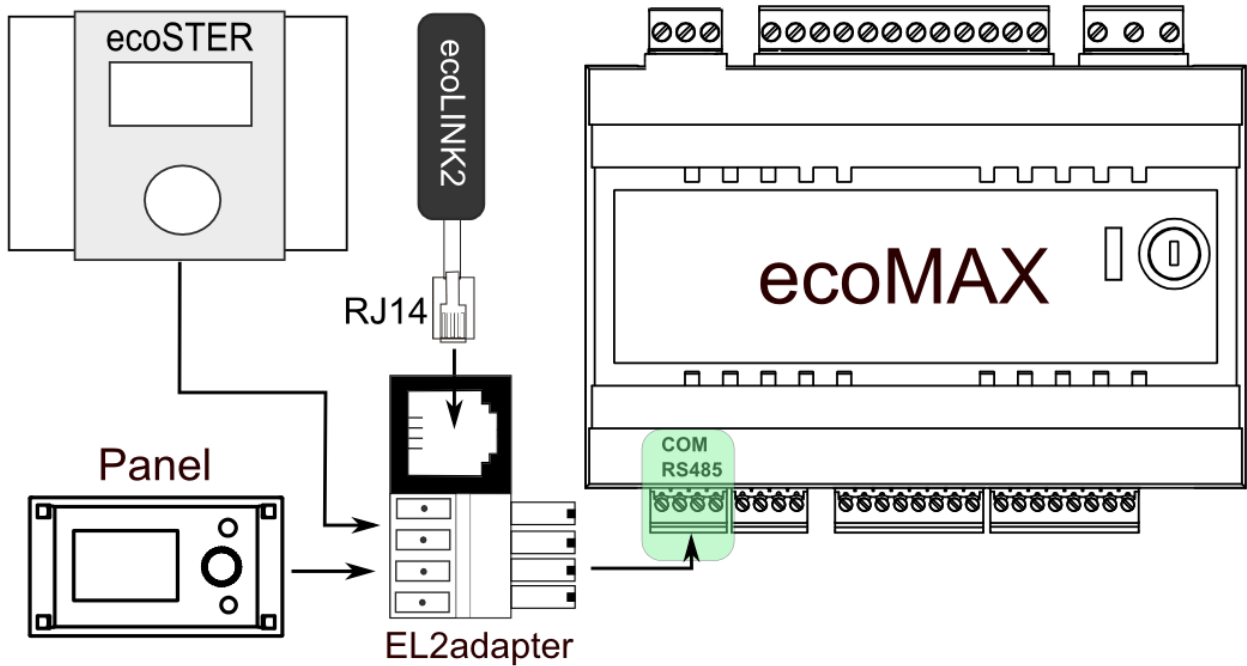



CONNECTION WITH ecoMAX850 SERIES CONTROLLERS

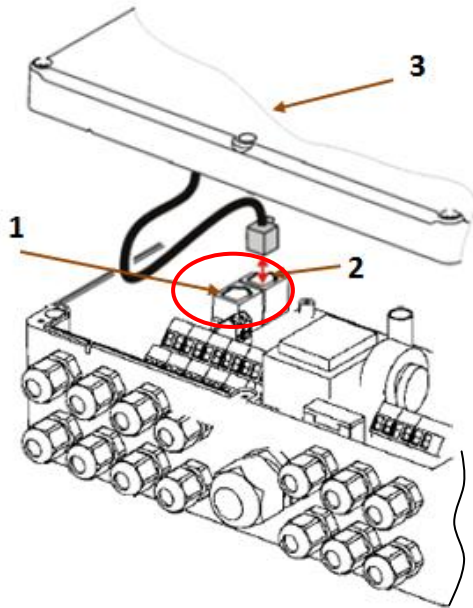

ecoMAX850P1 or **ecoMAX850D1** controller modules are equipped with an additional COM transmission socket to connect RJ14 plug of ecoLINK2 interface without using any adapters. Just unscrew the controller housing and put the plug into a **COM** socket.

- 1 - **COM** socket (place of plugging a RJ14 interface plug),
- 2 - a socket with connected plug of the control panel,
- 3 - controller housing cover (possible place where a control panel can be assembled)

Modules of **ecoMAX850P2** controllers are equipped with just one COM transmission socket in RJ14 standard which a control panel (located inside or outside the controller housing) is connected to. Using one RJ14 socket in the module requires connecting an additional divider (telephone RJ14 tee separator) and additional cable.



Standard divider, RJ14 telephone divider, where:

- 1- connection of RJ14 ecoLINK2 interface plug,
- 2- connection of the control panel plug,
- 3- Connection of an additional cable with two RJ14 terminals.

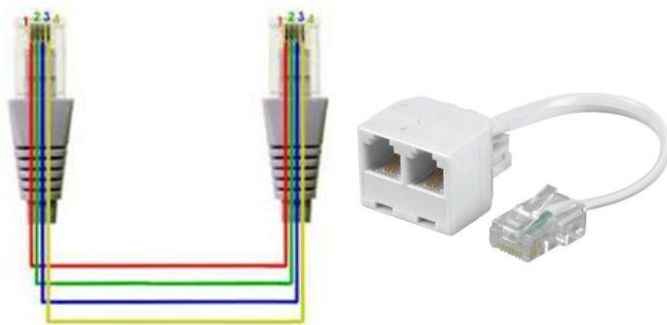

Standard RJ14 telephone cable with an option of connecting wires and a method of connecting into the divider.

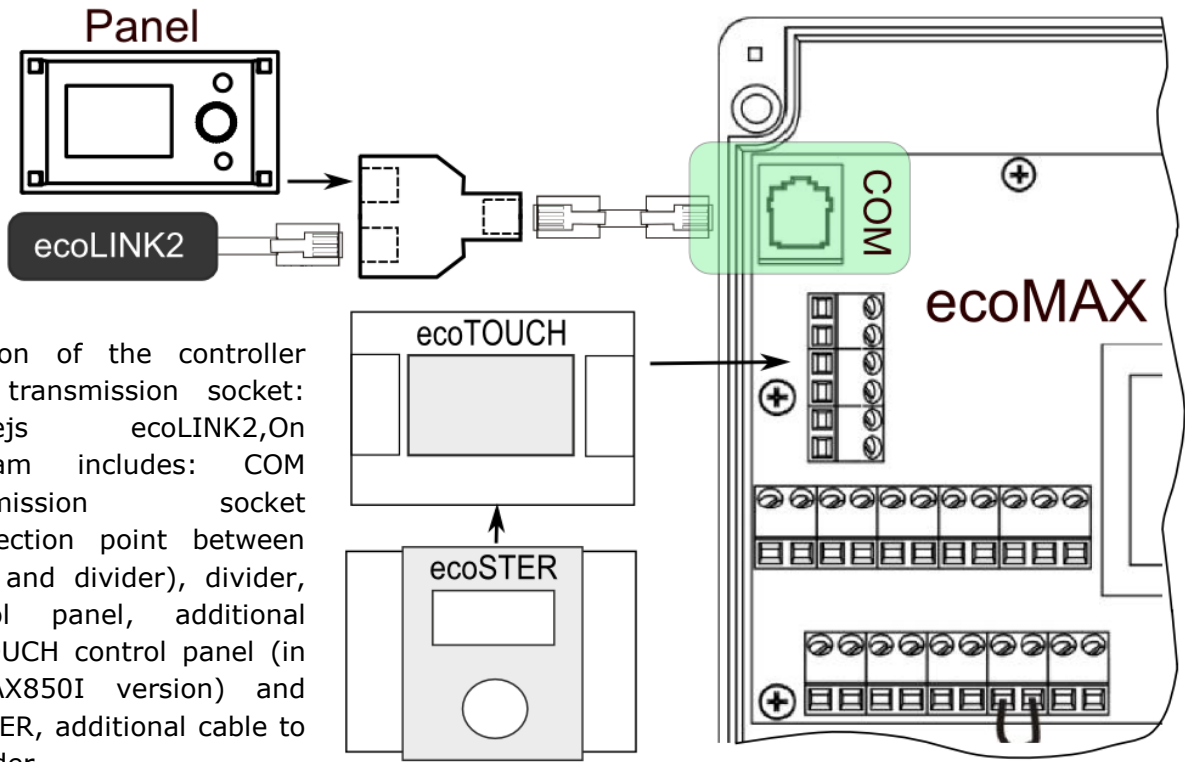

Location of the controller COM transmission socket: **ecoMAX**. On Diagram includes: **ecoLINK2**, **ecoTOUCH**, **ecoSTER**, **Panel**, **COM** transmission socket (connection point between cable and divider), divider, control panel, additional **ecoTOUCH** control panel (in **ecoMAX850I** version) and **ecoSTER**, additional cable to a divider.

CONNECTION WITH ecoMAX860 CONTROLLER

In case of **ecoMAX860** series, a **EL2adapter** must be used in order to connect **ecoLINK2**. The following diagram shows a connection method.

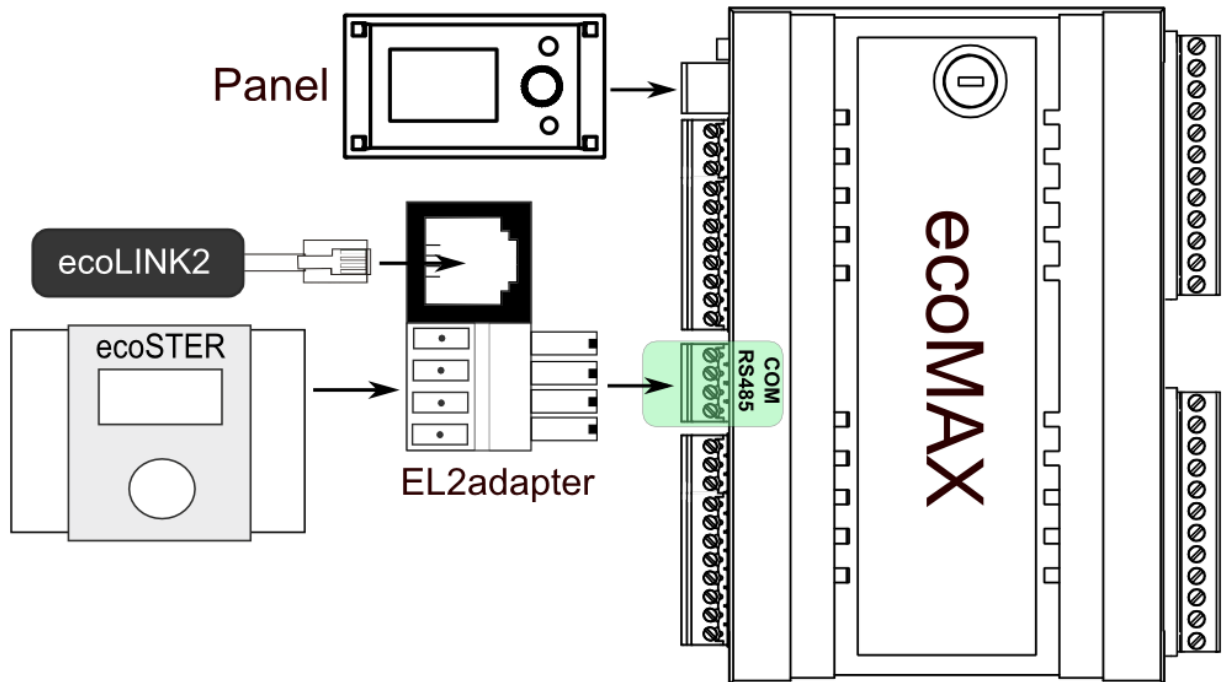



CONNECTION WITH INTERNET NETWORK



ecoNET300 requires constant access to a wire LAN or wireless WiFi network in a place of installation of the boiler controller.

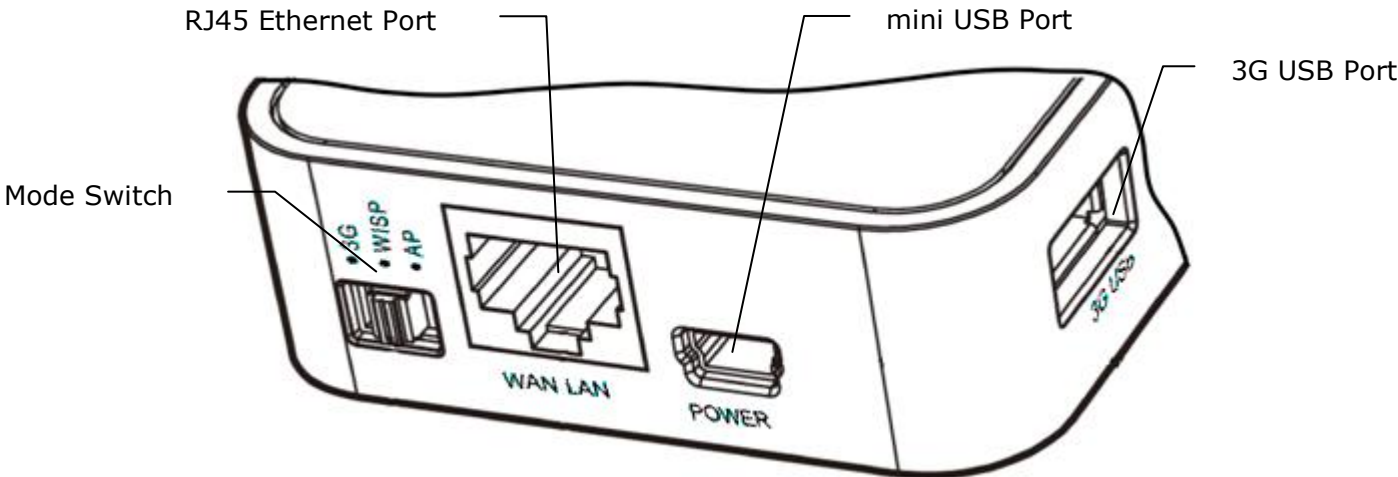

Connect adapter plug to a mini USB Port socket and 3G USB Port to the ecoLINK interface. Connect with RJ45 Ethernet Port with Ethernet cable, e.g. with ADSL router, switch and modem. A socket must not be use in case of WiFi wireless network access. Mode Switch can be set in any position.

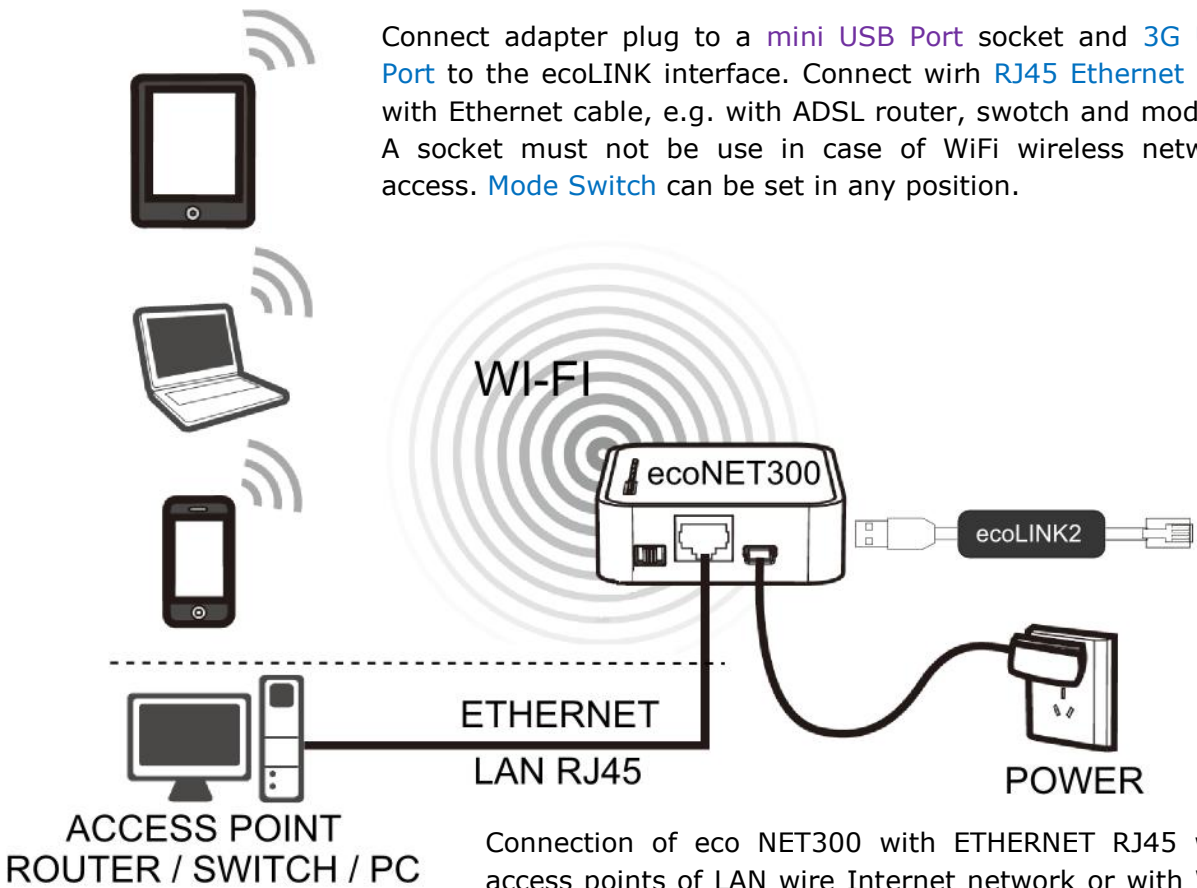

Connection of eco NET300 with ETHERNET RJ45 with access points of LAN wire Internet network or with WiFi wireless network.

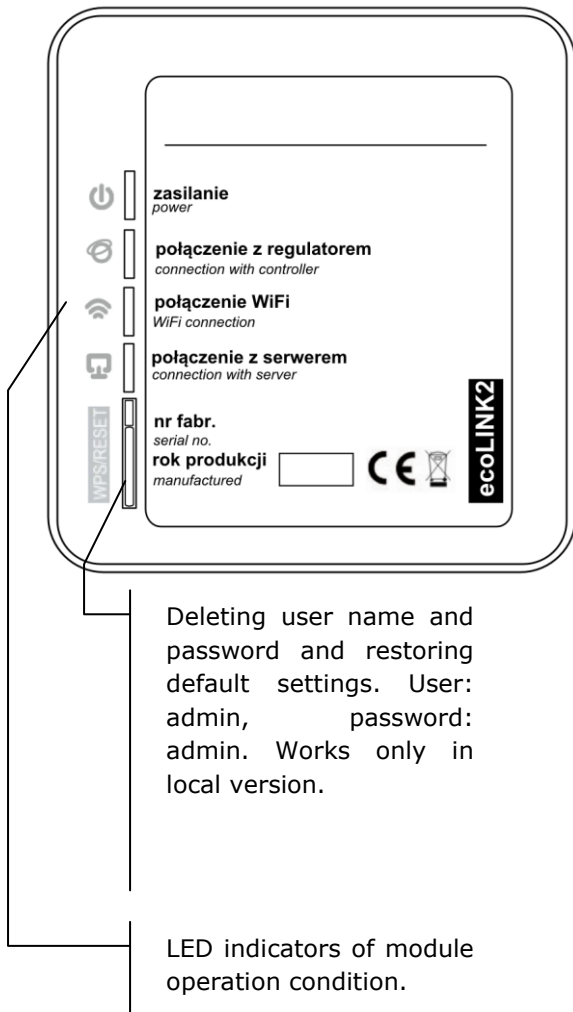

LED	Condition	ecoNET300 operation condition
	● on	Power on
	○ off	Power off
	● on	Active connection of the controller.
	○ off	No connection with boiler controller.
	● on	Connection to a programmed wireless network is on.
	○ off	No connection with wireless network.
	● on	Connection with ecoNET24.com external server is on.
	○ off	No connection for ecoNET24.com external server.

After the power is on, ecoNET300 requires app. 1 minute in order to load the operational system. Then, the module begins to work and indicates its condition with LED indicators. In a connection between ecoNET300 module with a boiler controller is active, a “ connection with controller” indicator lights up. New functions for managing ecoNET30 module are added to the main menu.

- MENU** → **Information** → **ecoNET WiFi**
- MENU** → **Information** → **ecoNET Ethernet**
- MENU** → **Main settings** → **WiFi**



ecoNET300 requires active DHCP server of Access Point (e.g. router) because manual IP assignment for ecoNET300 internet module is not supported. More information can be obtained from router configuration software or network administrator.



In case of connection with a chosen Access Point via wireless network, user has to know the settings of WiFi network which the module will be connected to: network name (SSID), protection type, access password).

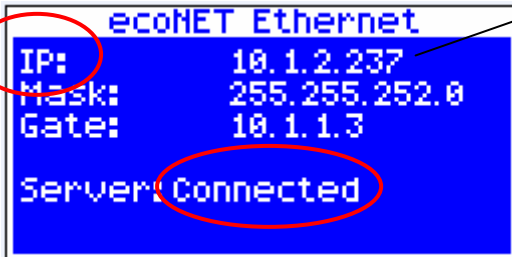

In case of connection with LAN wire network, a **ecoNET Ethernet** tab will be available in controller menu from which the **IP** number, mask and gate can be read out and ecoNET24.com connection condition can be checked. It is required to save the displayed **IP** number (e.g. IP: 10.1.2.237). This number in a form of: <http://10.1.2.237> is entered into the address field from the level of LAN network. A boiler controller menu management website will be activated.

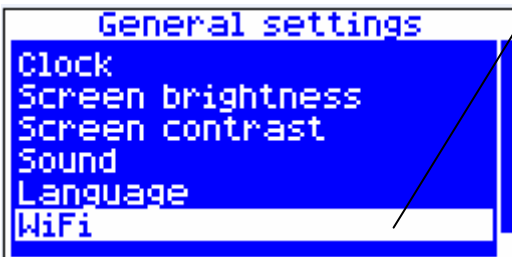
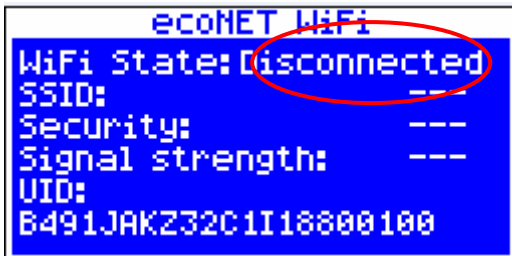

It is necessary to enter network parameters in **General settings** menu of the control panel in order to make a wireless connection via WiFi.



To do this, select:

MENU → **General settings** → **WiFi**



Select **SSID** in **Network Settings**. It is a name of the local wireless network which has to be the same for all devices working in this network (SSID can be, e.g.: myWiFi).



User can select letters / signs from the list with the use of the control panel "TOUCH and PLAY". Selected name is confirmed with  (ENTER).  (Backspace) symbol deletes previous character, and  (Space) provides a space between the characters.



In **Network settings** select **Security**.



Select and confirm encryption type in WiFi network (most often selected type is **WPA2**).

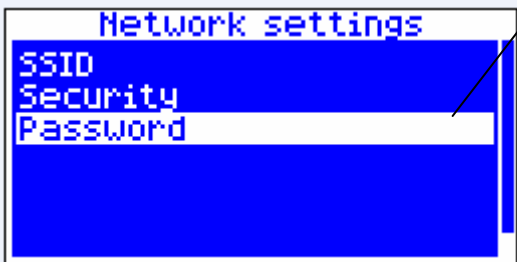

Go to **Password** tab

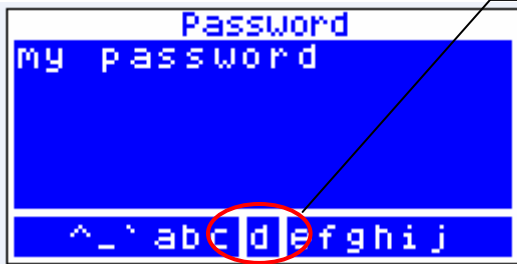

Enter Wi-Fi access password using letters / characters available on the list and a knob on the controller panel. Confirm with  (ENTER).

👍 Filling data correctly results in ecoNET300 connected to a Wi-Fi network.

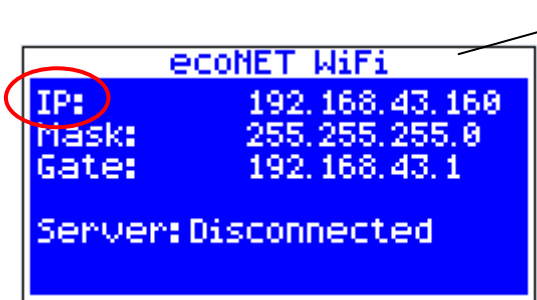

In **MENU** → **Information** → **ecoNET WiFi**, user can readout an **IP** number, Mask, gate and ecoNET24.com connection condition (required: **Server: Connected**). **IP** number is used for opening a boiler controller website from a level of LAN network.



Wi-Fi network parameters (SSID, protection type and password) can be also configured from a level of ecoNET300 website after previously connecting it to a LAN wire network.



LOGGING TO THE MODULE FROM A LEVEL OF LOCAL LAN NETWORK

WWW server incorporated in ecoNET300 module enables remote management of boiler operation on LAN local network without any access to the Internet.

Enter : *http://module IP address* in the address field of the internet browser.

Where: can be read out from the boiler controller menu:

MENU → **Information** → **ecoNET Ethernet** or **ecoNET WiFi**.

Activated page will ask for user and password. Default settings are:

User: **admin**

Password: **admin**

After correct login, a www for managing the boiler controller operation.

More information concerning managing this site is included in further parts of this manual.



In order to guarantee safety by preventing unauthorized persons from direct access to the controller, it is recommended to change default login settings (username password). To do this, enter "Device settings" on WWW for controller operation management and in "User" section click "Change password".



LOGGING INTO ecoNET ACCOUNT

ecoNET300 internet module cooperates with external server which is available under www.econet24.com. This provides access to the boiler controller via Internet.

In order to log into an account on an external server, enter www.econet24.com into an address field of the web browser.

In case of first logging, select: [Create new account](#)

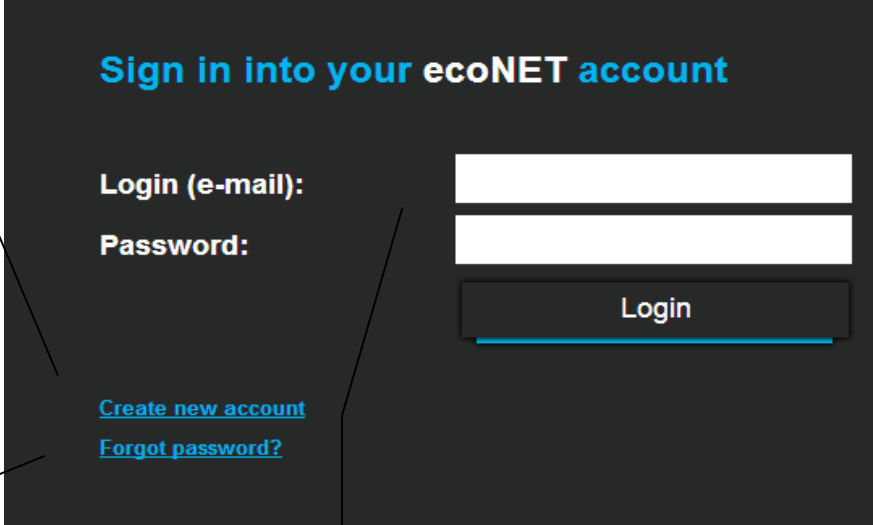

Reminding a password for existing account:

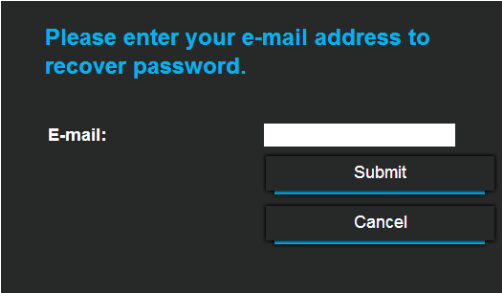

Select [Forgot your password?](#), enter e-mail address and press **Send**.

Enter your **login (e-mail)** and **password** in order to log into your ecoNET account.

In case of first logging, user has to create a new account. Following conditions must be met:

- 👍 Boiler controller has to be connected to a power supply and properly connected to ecoNET internet module.
- 👍 ecoNET300 module should be connected to the Internet and be logged into the external server ("server connection" indicator is active).



👉 From **ecoNET WiFi** tab in the boiler controller main panel, read the **UID** number (unique ID of the controller):

MENU → **Information** → **ecoNET WiFi**



Fill out the form to create a new account

First name:

Last name:

E-mail:

Password:

Verify Password: please enter your password again

Phone:

Rules Accept Date:

Street:

House / apartment:

Postal code / city:

Country:

Regulator UID:

Regulator label:

Advanced user: Service parameters edition

Remote access to the controller by the service and the producer:

Alarm notifications: Permit alarm notifications via e-mail.

Regulator installation address: Same as user address

I agree to the [Term of Service](#)

Fill in the form with user data and password.

Obligatory fields:

E-mail, Password, Password (again), UID identifier of the controller..

In a form field:

- ✓ **Regulator not available, try other UID or check if regulator is connected to the Internet).** **UID** number of boiler controller is required (in case of improper number or a lack on Internet connection), a following command will be displayed **Regulator not available, try other UID or check if regulator is connected to the Internet).** ecoNET24 server verifies whether UID number is correct.
- ✓ **Regulator label** – enter a name of your controller.
- ✓ **Advanced user (Edit service parameters)** – This option enables to change service parameters of the controller from a level of www site. After checking this option a password for service settings is required.



- ✓ *Remote access to the controller by the service and the producer* – enables to access and edit controller parameters via service and boiler manufacturer.
- ✓ *Enable sending alarm notices on e-mail* –In case an alert occurs, an alarm message including alarm contents will be sent. On previously entered e-mail address.
- ✓ *Regulator installation address (Similar as user address)* – Check this field if the controller address is the same as residential address.

ecoNET account can be created only after reading terms and conditions of operation and checking: *I agree with these terms and conditions*.

Press **[Register]**.



A WEBSITE FOR MANAGING OPERATION OF THE BOILER CONTROLLER

Description of menu on a website for managing operation of the boiler controller:

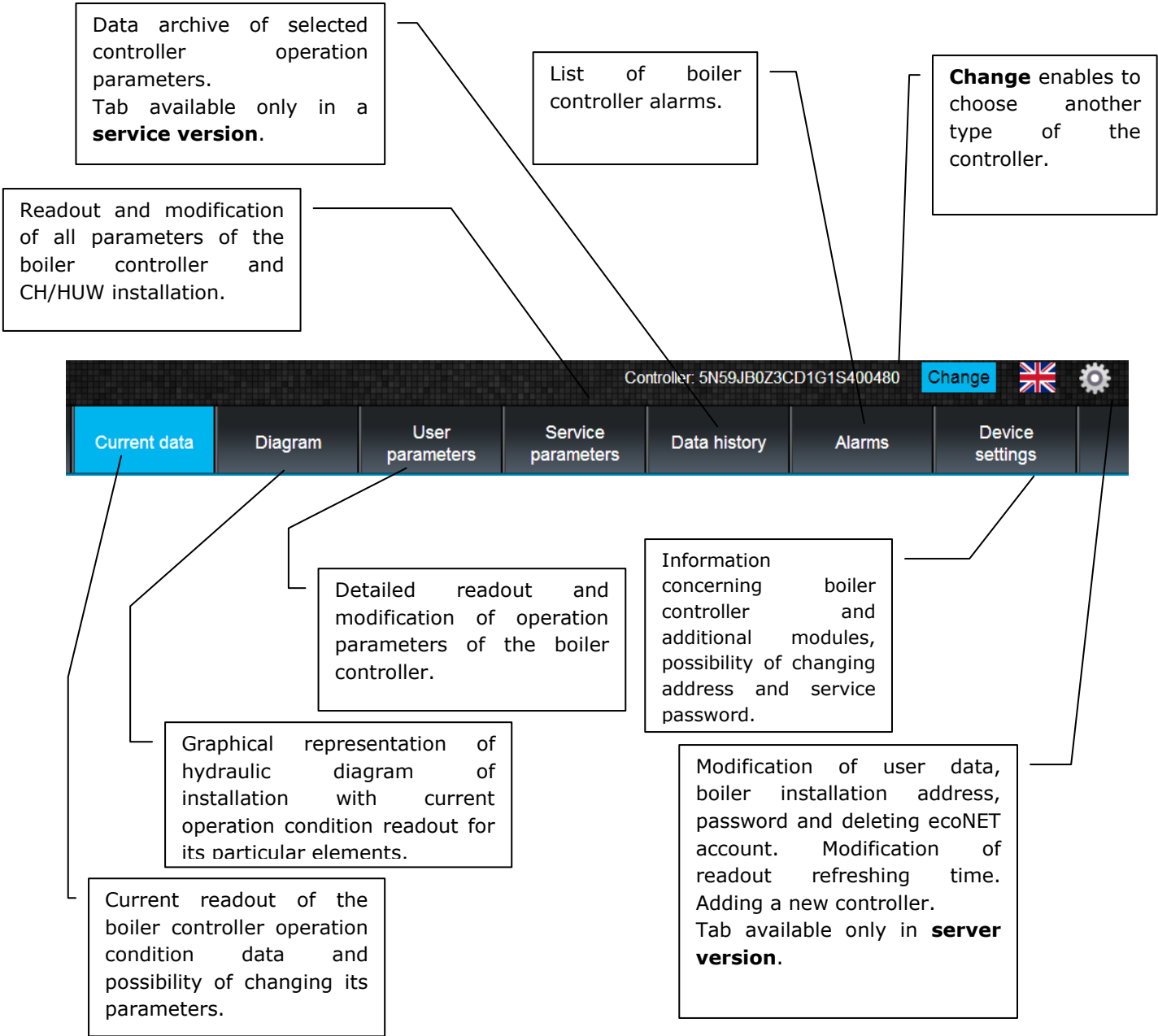

User is required to know the operation of the ecoMAX boiler in order to modify its values.

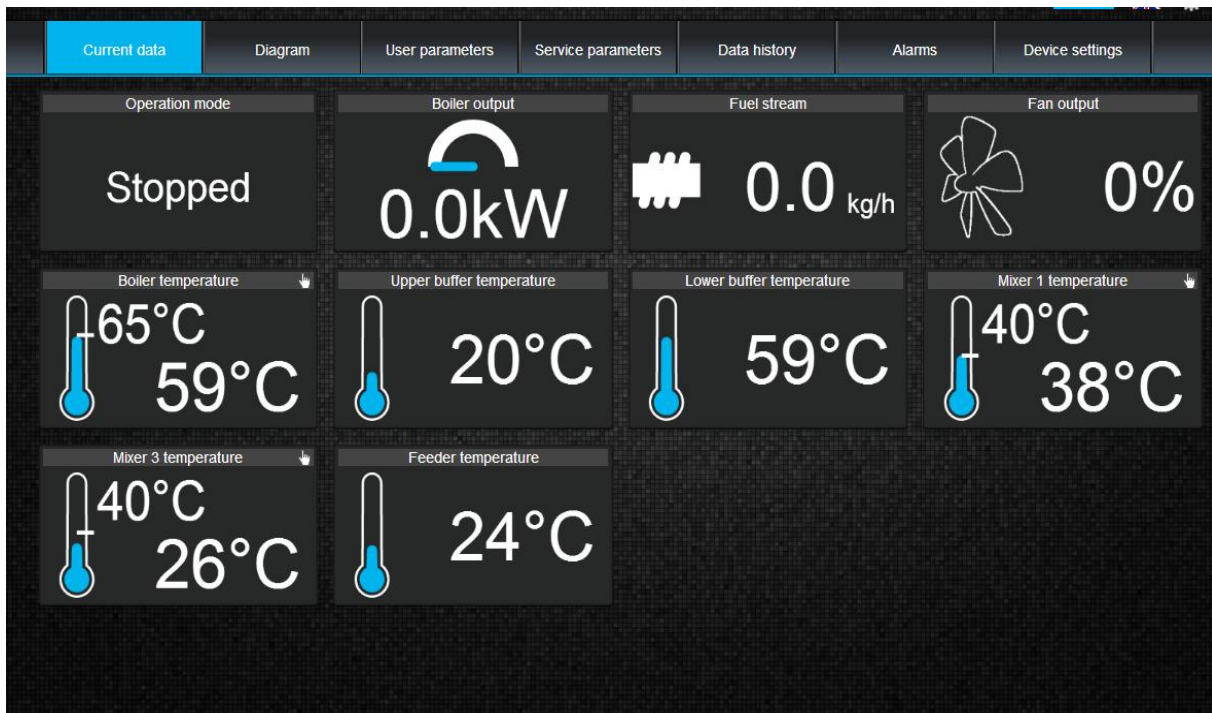

“Current Data” tab includes tiles with values of basic boiler operation parameters. Parameter refreshing time is preset by the user (tab: [Settings](#)).

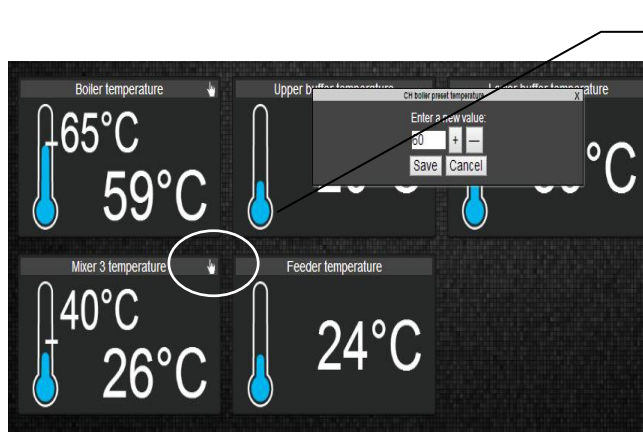



A parameter to be modified is indicated by  symbol. Click a tile and **Modify value** window will appear. Enter new value, e.g. *Boiler temperature* and confirm with **[Save]**.

“Diagram” tab includes graphical connection diagram between boiler and heating system in the building with readouts of parameters from sensors in particular points of the installation.

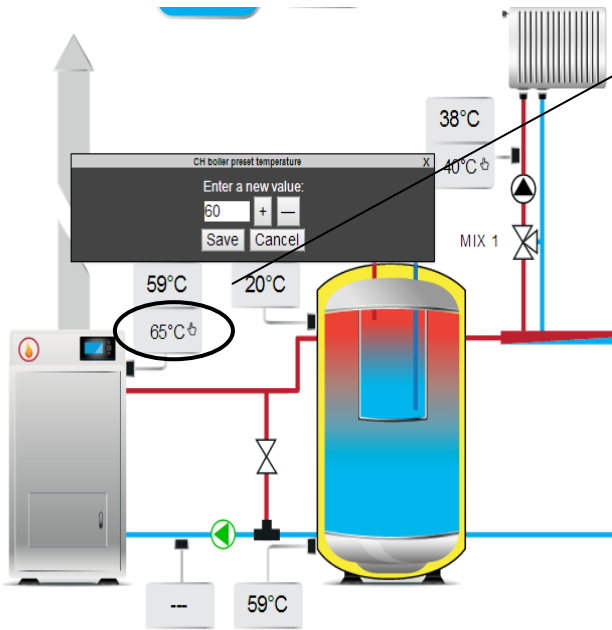

Current data	Diagram	User parameters	Service parameters	Data history	Alarms	Device settings
ecoMAXX800R						
 Operation mode Stopped	 Boiler output 0.0kW					
 Fuel level 100%	 Fuel stream 0.0kg/h					
 Fan output 0%	 Flame ---					



A parameter to be modified is indicated by  symbol. Click a tile and **Modify value** window will appear. Enter new value, e.g. *Boiler temperature* and confirm with **[Save]**.



Basic parameters of controller operation are displayed in “User parameters” tab. These parameters are grouped and all can be modified by the user.

Current data	Diagram	User parameters	Service parameters	Data history	Alarms	Device settings
▼ Boiler settings						
		CH boiler preset temperature			60	°C
		CH pump start-up temperature			40	°C
		Boiler thermostat operation mode			Off	
		Decrease in boiler preset temperature with shorted thermostat contact			8	°C
		CH pump standstill time during thermostat operation			3	min
		CH pump operation time despite shorted thermostat contact			60	s
		Airflow power at 100% of boiler power (primary airflow power in retort controllers)			36	%
		Feeder interval duration in SUPERVISION mode			15	min
▼ Mixer 1						
		Set temperature heating circuit			40	°C
		Lowering temperature set point of the circuit with shorted thermostat contact			8	°C
▼ Mixer 3						
		Set temperature heating circuit			40	°C
		Lowering temperature set point of the circuit with shorted thermostat contact			8	°C

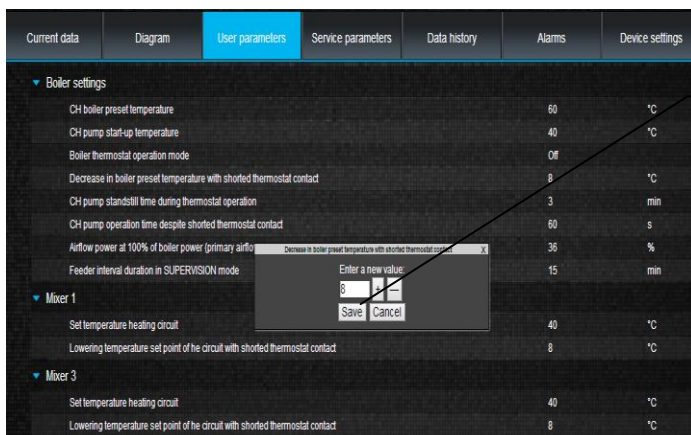

Click on a name of selected group of parameters, e.g. *Boiler settings* and open a list of available parameters. Select a parameter to be modified, enter new value in additional window and confirm with **[Save]**.

“Service parameters” tab enables to readout and modify service parameters of the boiler regulator. In order to do this, enter a password for service parameters in a “Device settings” tab in “Advanced user password” field.

“Data history” tab, only in **server version**, enables to readout registered parameters concerning operation of the whole heating system in a selected time and present it in the form of a graph.

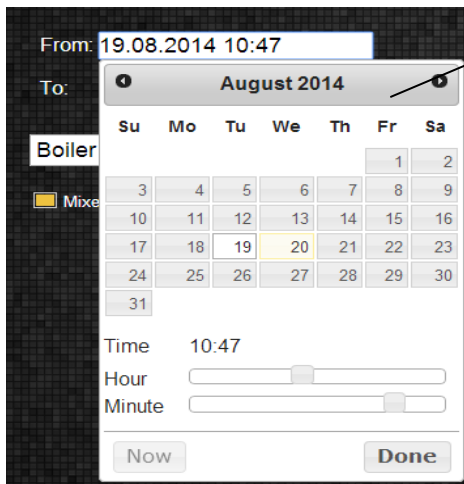
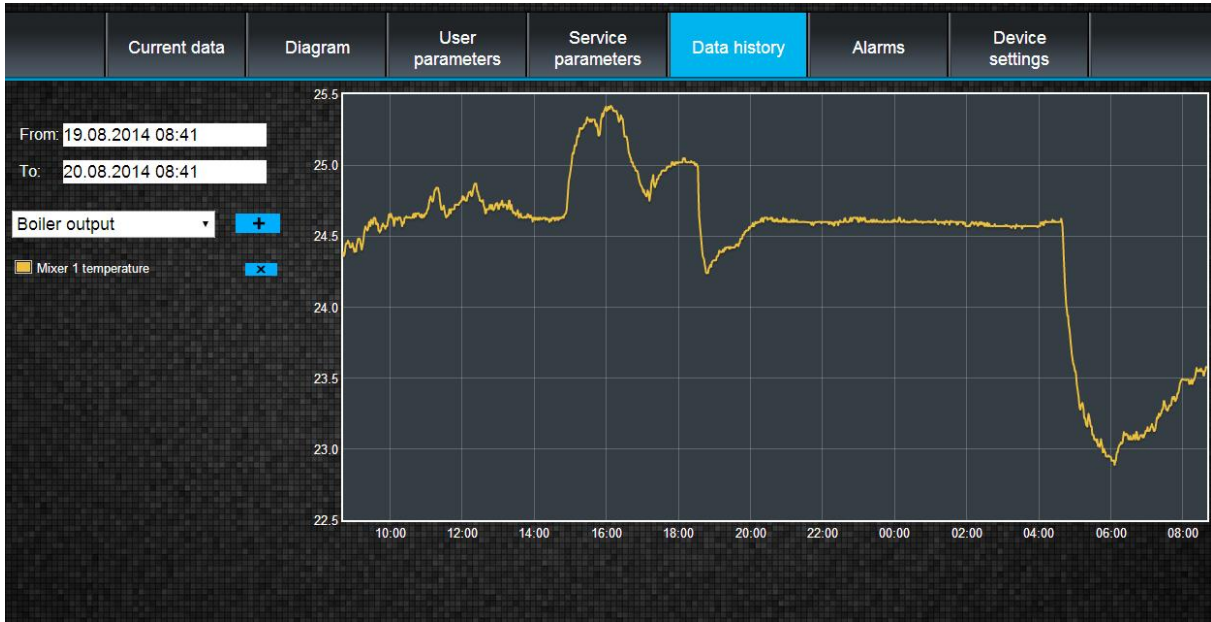

Choose a time period for data readout by clicking **From:** or **To:** (select date and time in a calendar). Confirm with **Done**.

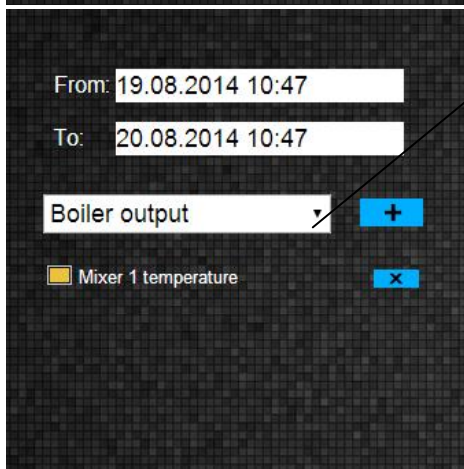

Select parameters from a drop-down list [▼] and confirm with [+] in order to add parameters to be visualized. Clear parameters with [X] button.



In "Alarms" tab:

- ✓ user can read a list of registered alarms and other events sent by the boiler controller.
- ✓ a type of alarm, event and period of its occurrence is displayed.

	Alarm	From:	To:
1	No power	2014-05-03 16:11:00	2014-05-03 16:12:53
2	No power	2013-10-12 08:23:00	2014-05-03 16:03:28
3	No power	2014-04-10 09:04:00	2014-04-12 03:46:23
4	Sensor fault feeder	2014-04-10 05:48:34	2014-04-10 05:49:47

Log into www.ecoNET24.com in order to display all logs of alarm conditions from the beginning of operation of the controller. Logging into a local LAN network gives a possibility to see only 100 newest logs.

Alarm notices can be sent on e-mail. It enables the user to react fast in order to restore normal operation of the boiler controller.



“Device settings” tab in **server version** enables to:

- ✓ change the boiler regulator installation address, label name, service access and advanced user password,
- ✓ readout a software version in the controller module and additional modules or panels,
- ✓ update internal ecoNET300 software,

Enter new data in a form and press **[Submit]**.

The screenshot shows a web interface for configuring a boiler regulator. It is divided into two main sections: 'Regulator installation address' and 'Other settings'. The 'Regulator installation address' section includes input fields for 'Street', 'House no.', 'Apartment (optional)', 'City', and 'Postal code', and a dropdown menu for 'Country' currently set to 'Poland'. The 'Other settings' section includes readouts for 'Software version' (1.10.1982), 'Module A version' (93.31.40.R1), and 'Module Panel version' (93.20.31). It also has a text input for 'Label' (5N59JB0Z3CD1G1S400), a dropdown for 'Remote access to the controller by the service and the producer' (modification), and a checkbox for 'Permit alarm notifications via e-mail' which is currently unchecked. A 'Submit' button is located at the bottom right of the form.

Regulator installation address:	
Street:	
House no:	
Apartment (optional):	
City:	
Postal code:	
Country:	Poland ▼

Other settings	
Software version:	1.10.1982
Module A version:	93.31.40.R1
Module Panel version:	93.20.31
Label:	5N59JB0Z3CD1G1S400
Remote access to the controller by the service and the producer:	modification ▼
Alarm notifications:	<input type="checkbox"/> Permit alarm notifications via e-mail.
Change advanced user password:	<input type="checkbox"/>

Submit



EcoNET24 server periodically checks availability of new software version for the ecoNET300 module. In **Device settings** tab it displays information concerning a new software version. All the user needs to do is to press **[Update]**.

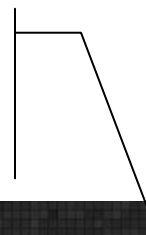

Software version:	1.10.1982
Module A version:	3.10.73.P1
Module Panel version:	3.15.45



Software update process can be shorter or longer depending on the speed of Internet connection. Do not disconnect the device from a power supply during update process because it will cause its damage.

Icon for modifying personal data of the ecoNET account. Update or modification of address data, deletion of account, adding a new device. Changes are applicable only to **server version**.

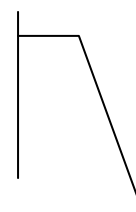

Controller: 5N59JB0Z3CD1G1S400480 Change  

Back to main page

Users data

First name:

Last name:

E-mail:

Phone:

Service Access:

Personal Data Access:

User address

Street:

House no:

Apartment (optional):

City:

Postal code:

Country:

Client

Refresh period [s]:

New device

Device UID:

Advanced user: Service parameters edition

Depending on what type of changes are made, choose an appropriate button and enter new data in selected fields.

All changes should be accepted with the following buttons: **[Save changes]**, **[Change password]**, **[Change user address]**, **[Set refreshing time]**.

User can enter a new ID number and add a new device to the ecoNET account. In *Advanced user* field: user can select an option to advanced parameter edition called *Service parameters edition*. In order to do this, the user has to enter a password for service parameters in the boiler controller. To delete the ecoNET account, select **[Delete account]**.



In "Settings" tab in **local version** user can:

- ✓ read the IP address and status of Ethernet or WiFi network (Connected/Disconnected),
- ✓ read the WiFi signal strength [%],
- ✓ display information concerning IP address of the main econet24 server, its status and availability. After pressing "Check server availability" button, user can check if the external server is available from a level of Internet browser (excluding ecoNET300 module),
- ✓ read information concerning selected controller: identifier, UID number, software version in controller module, additional modules and panels,
- ✓ update software to ecoNET300 (procedure similar as in server version),
- ✓ change login parameters: login and password.

When changing WiFi network, click **[Refresh network list]**, select *Network name*, and used *Type of security* (e.g. WPA2 Personal) and enter *Password* to a selected network.

In *Refresh rate [s]* user can define the interval in which server will readout data from the boiler.

All modifications must be confirmed by **[Apply]**.

The screenshot shows the following settings:

- Network:** Ethernet: 10.1.2.197 Connected; WiFi: 0.0.0.0 Disconnected. Network name: Select (dropdown); Signal level: (dropdown); Type of protection: None (dropdown); Password: (input field). Button: Refresh network list.
- Main server:** Address: econet24.com; Status: Connected. Button: Check server availability.
- Controller:** ID: (input field); UID: (input field); Type: em; Refresh rate [s]: 5 (input field).
- Application:** Software version: 1.10.1982; Module A version: 8.10.40.R1; Module Panel version: 93.20.31.
- User:** User name: admin; Password: ***** (masked). Button: Change password.

At the bottom of the settings area is an **Apply** button.

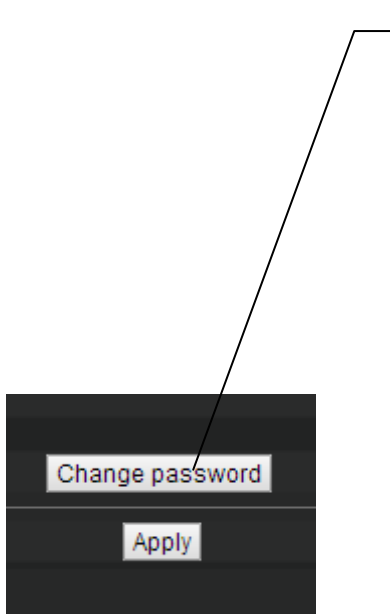

[Change password] key enables to change login data (user name and password) to the ecoNET300 Internet module.

Enter old and new data into fields. Save changes by clicking **[OK]**.



In case the user has forgotten his password for logging in the ecoNET300 Internet module, it is possible to restore default data with the use of a button on the ecoNET300 housing.

Default username and password (user: **admin**, password: **admin**) can be restored with the use of WPS/RESET button located near indicators on the ecoNET300 housing.

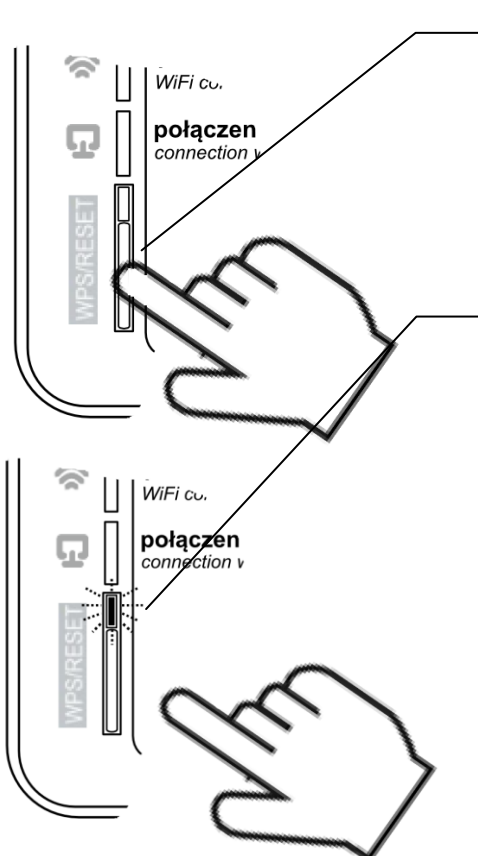

ecoNET300 module has to be connected to power supply:

1. Push WPS/RESET button during normal module operation,
2. Hold this button pressed for at least 10 seconds,
3. Release the WPS/RESET button,
4. A LED indicator near the button should flash several times,
5. Wait for app. 2 minutes,
6. The module will automatically start up and connect with the Internet.
7. Default username and password will be restored (user: **admin**, password: **admin**)



**Ignatki 27a, 16-001 Kleosin
Poland**

tel. +48 85 749-70-00

fax +48 85 749-70-14

plum@plum.pl

www.plum.pl

www.plumelectronics.eu